

Raymarine[®]

Ray218E & Ray55E Marine VHF Radio Owner's Handbook

Document number: 81279-3
Date: April 2007

Trademarks and registered trademarks

Raymarine is a registered trademark of Raymarine plc.

All other product names are trademarks or registered trademarks of their respective owners.

Contents of this handbook © Raymarine 2007

DSC VHF radio regulatory compliance

Technical accuracy

To the best of our knowledge, the information in this document was correct at the time it was produced. However, Raymarine cannot accept liability for any inaccuracies or omissions it may contain. In addition, our policy of continuous product improvement may change specifications without notice. As a result, Raymarine cannot accept liability for any differences between the product and this document. Please check the Raymarine website (www.raymarine.com) to ensure you have the most up-to-date version(s) of the documentation for your product.

IMO and SOLAS

The equipment described within this document is intended for use on leisure marine boats and workboats not covered by International Maritime Organization (IMO) and Safety of Life at Sea (SOLAS) Carriage Regulations.

Viewing distances

For optimal viewability the DSC VHF radio's LCD display should be viewed at a maximum distance of 0.7 metres.

Document number: 82258-1

Date: 06-2012

Introduction

The purpose of this document is to list the changes which have been applied to the Ray55 and Ray218 DSC VHF radios to ensure compliance with the requirements of the following international standards:

- ITU-R M.493-13
- IEC62238
- EN 301 025-2
- EN 301 025-3

Note: The information contained in this document takes precedence over the information contained within the Owner's handbook (supplied with your radio).

No GPS position

If no GPS data is available and the MMSI number has been programmed, after 10 minutes of no data the GPS icon flashes, **NO POS DATA** and **NO GPS** is displayed on screen and an audible warning is sounded.

Once the warning has been acknowledged the GPS icon will continue to flash and **NO GPS** will remain on screen. The warning will be repeated every 4 hours as long as position data is still unavailable or has not been entered manually.

If position data has been entered manually but has not been updated during the previous 4 hours the GPS icon flashes, **POS DATA OLD** is displayed on screen and an audible warning is sounded. This warning will be repeated every 4 hours until position is manually updated or GPS position data becomes available.

Where no position data is available or has not been manually updated for 23.5 hours then position data will change to '9's and time data will change to '8's.

Distress calls

Designating a distress call

To send a distress call and specify its nature follow the steps below:

1. Press and hold the **Menu DSC** button for 3 seconds to display the **DSC menu**.
2. Select **Distress**.
The following options are available: Undesignated, Fire, Flooding, Collision, Grounding, Capsizing, Sinking, Adrift, Abandoning, Piracy and Man overboard.
3. Select the nature of the distress from the list.
4. Press and hold the **DISTRESS** button for 3 seconds to initiate the call. During this time, the radio beeps, the display flashes and a timer counts down 03...02...01..., the call is then transmitted.

Cancelling a distress call before transmission

To cancel a distress call before it is transmitted follow the steps below:

1. Release the **DISTRESS** button before the count down timer completes.

When the button is released you will be returned to normal operation.

Cancelling a distress call after transmission

To cancel a distress call after it has been transmitted follow the steps below:

1. Press the **Cancel** soft key.

A warning is displayed to inform the user that they are about to send a 'Distress cancel call'.

2. Press the **Send** soft key.

The 'Distress cancel call' is sent.

3. Press the **OK** soft key.
4. Make a broadcast to all stations giving your vessel's name, call sign and MMSI number and cancel the false distress alert

Example: "All, Stations, All Stations, All Stations. This is <NAME>, <CALL SIGN>, <MMSI ID>, <POSITION>. Cancel my distress alert of <DATE>, <TIME>, <NAME>, <CALL SIGN>".

5. Repeat the broadcast described in step 4.
6. Press **End** to revert back to normal operation.

Resuming an interrupted distress call

If a distress call has been made but has been interrupted by a power cycle of the equipment follow the steps below:

1. If you wish to continue the distress call press the **Resume** soft key, or
2. If you wish to cancel the distress call press the **End** soft key and then follow the steps to announce the cancelled distress call.

Test calls

Test calls should be carried out in accordance with *DSC VHF radio test calls – 82244-1* (supplied with your DSC VHF radio).

Viewing or entering MMSI ID number

To enter or view the MMSI ID number of your DSC VHF radio follow the steps below:

From the **DSC Menu**:

1. Select **My MMSI**.

The programmed MMSI ID number is displayed, or if the MMSI ID number has not yet been programmed you will be able to enter an MMSI ID number.

Note: Once programmed you will not be able to modify your MMSI ID number.

Group MMSI setup

You can programme up to twenty group MMSI ID numbers and associated group names, which can be up to eleven characters long. Group MMSI ID numbers always begin with a zero (0). You only enter the last 8 digits of the group ID number; the initial '0' is automatically entered for you.

Adding a new group

From the DSC menu:

1. Select **My Group ID**.

If an existing group name and MMSI ID number are already stored, those values appear. If blank, <EMPTY 1>, <EMPTY 2>, etc. are shown to indicate that the GROUP IDs have not yet been programmed.

2. Select the first available empty group location.

3. Use the **CH/OK** rotary control to change the highlighted character to the required value.

The leading '0' is automatically entered for you. The first character space you can modify is highlighted with a flashing underline.

4. Press **OK** to confirm selection and highlight the next character.

5. repeat steps 3 and 4 until the full MMSI number is displayed.

When you press **OK** to accept the final MMSI ID digit, the cursor moves on to the first digit of the group name field

6. Repeat steps 3 and 4 to enter the group name.

7. Press the **Done** soft key to complete the entry.

The new entry will now appear in the list.

Editing an existing group

You can edit an existing group by following the steps below.

From the **DSC** menu:

1. Select **My Group ID**.

A list of available groups is displayed.

2. Select the required group.

3. Select **Edit**.

4. Use the **CH/OK** rotary control to change the highlighted character to the required value.

The leading '0' is automatically entered for you. The first character space you can modify is highlighted with a flashing underline.

5. Press **OK** to confirm selection and highlight the next character.

6. repeat steps 4 and 5 until the required MMSI number is displayed.

When you press **OK** to accept the final MMSI ID digit, the cursor moves on to the first digit of the group name field

7. Repeat steps 4 and 5 to enter the group name.

8. Press the **Done** soft key to complete the entry.

Deleting a group

To Delete an existing group follow the steps below.

From the **DSC** menu:

1. Select **My Group ID**.

A list of available groups is displayed.

2. Select the required group.

3. Select **Delete**.

4. Press the **Delete** soft key.

DSC Menu structure

The structure of the menu that appears when the **Menu DSC** button has been pressed and held for 3 seconds is shown below:

Menu item	Options
Individual	<ul style="list-style-type: none"> Manual call Phonebook list
Distress	<ul style="list-style-type: none"> Undesignated Fire Flooding Collision Grounding Capsizing Sinking Adrift Abandoning Piracy Man over board
All Ship	<ul style="list-style-type: none"> Urgency Safety
Group	<ul style="list-style-type: none"> Call My Group ID
Position request	<ul style="list-style-type: none"> Manual call Phonebook list

Menu item	Options
Test Call	<ul style="list-style-type: none"> Manual call Phonebook list
Received calls	<ul style="list-style-type: none"> Unread calls Distress Other calls Position acknowledged
My MMSI	<ul style="list-style-type: none"> MMSI ID
Phonebook	<ul style="list-style-type: none"> New entry Phonebook list
My Group ID	<ul style="list-style-type: none"> List of groups
DSC Options	<p>Auto CH Tune</p> <ul style="list-style-type: none"> On Off (default) <p>Individual Reply</p> <ul style="list-style-type: none"> Manual (default) Auto <p>Auto End</p> <ul style="list-style-type: none"> Set Timer — Default is 30 seconds. Disable <p>Pos Reply</p> <ul style="list-style-type: none"> Auto (default) Manual

Contents

Trademarks and registered trademarks	2
About this Handbook	9
Important Information	10
Group MMSI ID	10
Antenna Mounting and EME Exposure	11
Safe Compass Distance	11
EMC Conformance	12
Duty Cycle	12
Chapter 1: Introduction	13
1.1 Ray218E and Ray55E Fixed Station VHF Radios	13
1.2 Features	13
Digital Selective Calling (DSC)	14
Chapter 2: Installation	15
2.1 Unpacking and Inspection	15
Removing the Sun Cover	15
Equipment Supplied	16
2.2 Planning the Installation	17
2.3 Cable Connections	20
Power	21
Hailer Horn (Ray218E only)	22
External Speaker	22
Raymic / Mic Relocation	22
NMEA Data	23
NMEA IN (from GPS)	24
NMEA OUT (to Chartplotter Display)	24
Antenna	25
Grounding	26
Chapter 3: General Operations	27
3.1 Keypad and Rotary Knobs	27
Microphone Keys	28
1. PTT	28
2. HILO / LOC DIST	28
3. 16/PLUS	28
4. UP/DOWN	28
5. SCAN / SAVE	28
Transceiver Controls	28
6. CH/OK	28
7. PWR/VOL	28
8. SQ	28

9. Soft Keys	29
Transceiver Push Keys	29
10. HAILER / INTCM (Ray218E only)	29
11. MENU/DSC	29
12. CLEAR	29
13. 16/PLUS	29
14. DISTRESS	29
Optional Raymic Second Station	30
A. PTT	30
B. VOL/SQ	30
C. CLEAR	31
D. 16/PLUS	31
E. Soft Keys	31
F. MENU / DSC	31
G. CH	31
H. OK / INTCM	31
3.2 Transceiver LCD	32
1. (RX) Receiving	32
2. (TX) Transmitting	32
3. (HI/LO) TX Power	32
4. ATIS Active	32
5. (SAVED) Memory Mode	32
6. (LOCAL) Local/Distant Mode	33
7. (FAV123) Favorite Channel	33
8. Automatic Channel Changing Blocked	33
9. GPS	33
10. DSC Call	33
11. Weather Alert	33
12. Dot Matrix Display	33
13. (MAN) Manual Position Data	33
14. Channel Status	34
15. Soft Key Labels	34
16. Channel Name	34
17. Channel Number	34
18. Channel Set	34
19. Signal Strength	34
Display Mode	34

3.3	Alert Messages	35
3.4	Turning the Power ON and OFF	35
3.5	Setting the Volume	36
3.6	Setting the Squelch	36
3.7	Tuning the Channel	36
3.8	Selecting a Weather Channel (If Licensed)	37
	Weather Alert Operation (If Available)	37
3.9	Selecting the Priority Channel	38
3.10	Selecting the Secondary Priority (PLUS) Channel	38
	Reprogramming the Secondary Priority (PLUS) Channel	39
3.11	Transmitting	39
3.12	Menu Mode Operation	40
3.13	DSC Call Operation	40
Chapter 4:	Menu Settings	41
4.1	Menu Function	41
	Making Menu and Programming Selections	41
4.2	VHF Operations	44
	Scan Mode	44
	All Scan	45
	Priority All Scan	46
	Saved (Memory) Scan	46
	Priority Saved Scan	47
	Display Mode	47
	Setting the Power Output (HI/LO)	48
	Saving Channels to Memory	49
	Using the Watch Modes	50
	Dual Watch	50
	Tri Watch	50
	Frequency Band	51
	Channel Name	52
	Favorite Channel	53
	Sensitivity	55
4.3	Hailer/Fog Horn/Intercom	55
	Hailer (Ray218E only)	55
	Fog Horn (Ray218E only)	56
	Intercom	57
4.4	GPS/Time Setup	58
	Manual Position	58
	Settings	60
	Latitude/Longitude Display	60
	Time Display	60
	Time Offset	60

	Time Format	60
	COG/SOG Display	61
	NMEA Output	61
4.5	ATIS Operation	63
	My ATIS ID	63
	ATIS Function	65
4.6	System Configuration	66
	Backlight Adjustment	66
	Contrast Adjustment	66
	Key Beep	67
	Signal Bar	67
	Bearing Mode	67
	Speed Unit	68
	System Test	68
	Version Number	69
	Reset	69
	VHF OPS	69
	GPS SETUP	69
	SYSTEM CONFIG	70
	DSC MENU	70
Chapter 5:	Digital Selective Calling (DSC)	71
5.1	DSC Call Menu	71
	Making DSC Menu and Programming Selections	72
5.2	Distress Calls	74
	Sending a Distress Call	74
	Undesignated (Quick) Distress Call	74
	Designated Distress Call	75
	Transmitting	76
	Receiving Acknowledgement	76
	Cancelling a Distress Call Made in Error	76
	Receiving a Distress Call	77
	Receiving a Distress Relay Sent by Another Station	78
5.3	DSC Phonebook	78
	Adding a new Entry	79
	Editing an Existing Entry	80
	Deleting an Existing Entry	81
5.4	Individual Calls	81
	Making DSC Calls to Coast Stations	81
	Transmitting an Individual Call	81
	Receiving Individual Calls	83
5.5	Group Calls	85
	Group MMSI Setup	85

Adding a New Group	85
Transmitting a Group Call	86
Receiving Group Calls	87
5.6 All Ships Calls	89
Transmitting an All Ships Call	89
Receiving an All Ships Call	90
5.7 Position Request	91
Specifying the Target Vessel	92
Retrieving the Last Received Position Data	93
Receiving a Position Request From Another Station	93
5.8 Received Calls (Logs)	94
Log Entry Options	95
5.9 DSC Setup	96
My MMSI ID	96
Automatic Channel Changing for Incoming Calls	98
Position Reply	99
Chapter 6: Customer Service	101
6.1 How to Contact Raymarine	101
On the Internet	101
Customer Support	101
Product Repair and Service	101
Accessories and Parts	102
Worldwide Support	102
Appendix A: Specifications	103
General	103
Transmitter	104
Receiver	104
Appendix B: Radio Controls	105
Microphone Keys	106
Transceiver Controls	106
Transceiver Push Keys	106
Optional Raymic Handset	107
Raymic Keys	108
Appendix C: Menu Structure	109
Appendix D: Channel List	111
International Marine VHF Channels & Frequencies	111
U.S. Marine VHF Channels and Frequencies	114
Canadian Marine VHF Channels and Frequencies	117
European Private Channels and Frequencies	122

Appendix E: Glossary 123
Index 125

About this Handbook

Intended Use

This handbook describes the Ray218E and Ray55E fixed VHF marine radios. The Ray218E and Ray55E provide two-way communications on all International marine channels, pre-set private channels, and (if programmed) all US and Canadian and marine channels. The Ray218E and Ray55E include equipment for Class "D" Digital Selective Calling (DSC).

Conventions Used

Throughout this handbook, the dedicated (labelled) keys are shown in bold capitals (for example: **MENU/DSC**). The LCD indicators and functions are shown in normal capitals (for example: TX).

Technical Accuracy

To the best of our knowledge, the information in this handbook was correct as it went to press. However, our policy of continuous product improvement and updating may change specifications without prior notice. As a result, unavoidable differences between the product and handbook may occur from time to time. Raymarine cannot accept liability for inaccuracies or omissions it may contain.

For the latest handbook revisions and product information visit our web site:

www.raymarine.com

Warranty

To register your new Raymarine product, please take a few minutes to fill out the warranty registration card found at the end of this handbook. It is very important that you complete the owner information and return the card to the factory in order to receive full warranty benefits.

Important Information

Licensing

Prior to using your Ray218E or Ray55E, please check your national requirements for both operators and equipment licensing.

Maritime Mobile Service Identity (MMSI)

The Ray218E and Ray55E include equipment for Class “D” Digital Selective Calling (DSC). A nine-digit Maritime Mobile Service Identity (MMSI) number is required to operate the DSC equipment. In some areas, a radio operator license is required before an MMSI number will be issued.

Note: *You can request an MMSI number from the same agency that issues radio or Ship Radio licenses in your area. Once obtained, you can program the MMSI number into your Ray218E/Ray55E as described in this handbook.*

Group MMSI ID

A Group ID MMSI number can also be entered for vessels that are part of a group, such as a flotilla or racing fleet, enabling DSC communications within the group.

Automatic Transmitter Identification System (ATIS)

If you purchased your Ray218E/Ray55E to include use on the inland waterways of the contracting governments of the “Regional Arrangement Concerning the Radiotelephone Service on Inland Waterways” — also known as the Basel Agreement¹ — your Ray218E/Ray55E will be programmed by your dealer to include Automatic Transmitter Identification System (ATIS) functionality. ATIS includes data at the end of radio transmission that identifies your station. ATIS operation can be turned on or off as needed via the radio’s Menu mode.

Your ATIS ID number is derived from your vessel’s call sign. If your call sign is suitable, your authorized Raymarine dealer can assist you in decoding your ATIS ID number, which you can then program into your Ray218E/Ray55E using the operation described on page 63.

1. The Basel Agreement includes Germany, Austria, Belgium, Bulgaria, Croatia, France, Hungary, Luxembourg, Moldova, the Netherlands, Poland, Romania, Russian Federation, the Slovak Republic, Switzerland, the Czech Republic, Ukraine and the Federal Republic of Yugoslavia.

Note: *When ATIS is enabled, certain programming steps have been implemented to protect the integrity of the Basel Agreement, including the blocking of DSC functions when ATIS is active. See "ATIS Function" on page 65.*

Safety Notices

Your Raymarine VHF radio generates and radiates radio frequency (RF) electromagnetic energy (EME). This equipment must be installed and operated in accordance with the instructions contained in this handbook. Failure to do so can result in personal injury and/or product malfunction.

Antenna Mounting and EME Exposure

For optimal radio performance and minimal human exposure to radio frequency electromagnetic energy, make sure the antenna is:

- located at least 1.5 meters (5 feet) from the radio
- connected to the radio before transmitting

This system has a Maximum Permissible Exposure (MPE) Radius of 1.5 meters, assuming the maximum power of the radio and antennas with a maximum gain of 3dBi. Accounting for the height of an average adult (2 meters) the minimum height of the antenna above the deck to meet RF exposure compliance requirements is 3.5 meters. Antennas with more gain require a greater MPE radius. Do not transmit when anyone is within the MPE radius of the antenna, unless shielded from the antenna field by a grounded metallic barrier.

WARNING: Maximum Permissible Exposure

Failure to observe these guidelines may expose those within the maximum permissible exposure (MPE) radius to RF radiation absorption that exceeds this limit. It is the operator's responsibility to ensure that no one comes within this radius.

WARNING: Microwave Radiation

Operators with cardiac pacemakers, electric-medical equipment and life support machines should not be exposed to microwave radiation.

CAUTION: Antenna Connection

Never operate the radio unless it is connected to the antenna.

Safe Compass Distance

Safe Compass Distance is 1 meter for a common compass. To be sure, you should locate the radio as far as possible from the compass. Test your compass to verify proper operation while the radio is also operating.

EMC Conformance

All Raymarine equipment and accessories are designed to the best industry standards for use in the recreational marine environment. Their design and manufacture conform to the appropriate Electromagnetic Compatibility (EMC) standards but correct installation and use is required to ensure that performance is not compromised.

Duty Cycle

The normal duty cycle of the Ray 218E / Ray55E is 5% transmit, 5% receive, and 90% standby.

Product Disposal



Waste Electrical and Electronic Equipment (WEEE) Directive

The WEEE Directive requires the recycling of waste electrical and electronic equipment. While the WEEE Directive does not apply to some of Raymarine's products, we support its requirements as part of our environmental policy and we ask you to be aware of how you should dispose of this product.

The wheeled bin symbol found on our products signifies that it should not be disposed of in general waste or landfill. Please contact your local dealer, national distributor or Raymarine Technical Services for information on product disposal.

Declaration of Conformity

Raymarine plc declare that the Ray218E and Ray55E fixed VHF marine radios are in compliance with the essential requirements of R&TTE directive 1995/5/EC.

The original Declaration of Conformity certificate can be viewed on the relevant product page at www.raymarine.com.

Chapter 1: Introduction

1.1 Ray218E and Ray55E Fixed Station VHF Radios

The Ray218E and Ray55E marine VHF radiotelephones are microprocessor-controlled transceivers that provide reliable simplex (single frequency) and semi-duplex (two frequency) communications. This handbook describes the physical and functional characteristics of these radios.

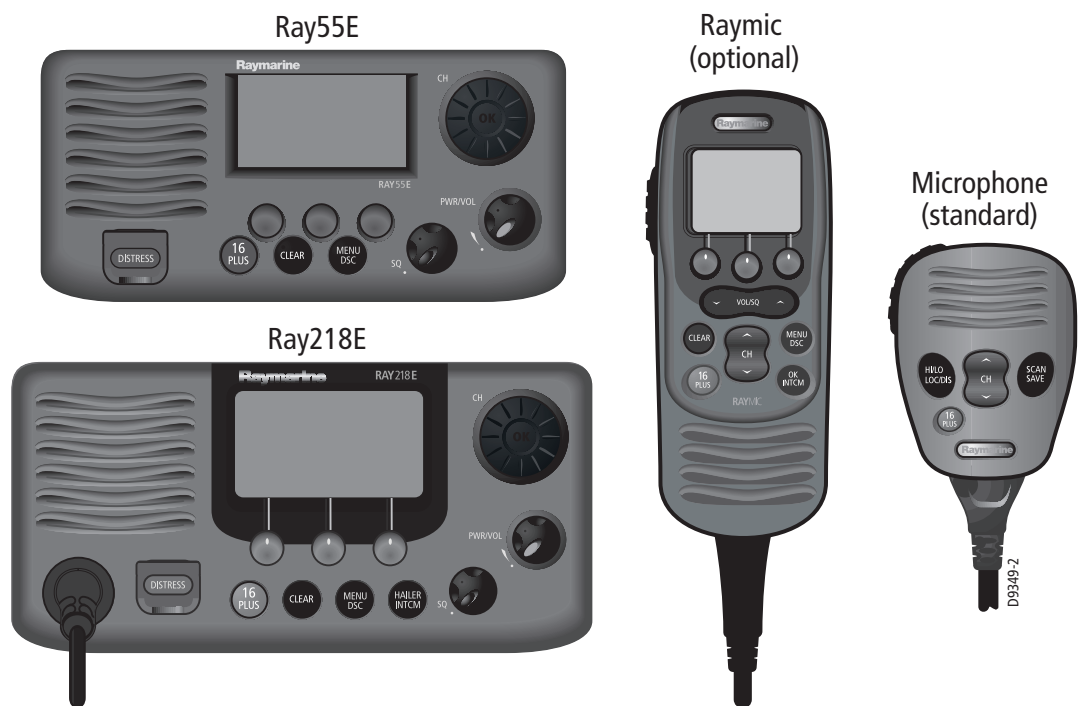

The Ray218E and Ray55E provide two-way communications on all International marine channels, pre-set private channels, and (if programmed) all US and Canadian marine and weather channels. Refer to the Frequency Tables in Appendix D, which list all marine VHF channels available in your radio. You should familiarize yourself with these tables to ensure proper channel usage.

1.2 Features

The Ray218E and Ray55E are designed and manufactured to provide ease of operation with excellent reliability. The Ray218E and Ray55E have many enhanced features, including:

- Waterproof to IPX-7 standard
- Anti-glare 1.9" (48mm) x 1.3" (32mm) LCD full dot matrix display
- 3 soft keys for easy programming and menu selection

- Dedicated key for switching to Priority Channel 16
- Programmable Secondary Priority (PLUS) Channel key
- ATIS operation, if required
- Private Channels (if so licensed)
- All Scan, Memory Scan and 2 Priority Scan functions
- Dual/Tri Watch Monitor modes
- Enhanced GPS Position Data gives Latitude and Longitude to 1/10,000 of a minute plus Time, SOG and COG data from any NMEA input
- Automatically distinguishes between calls made to Ship or Coast Stations
- Low and High Voltage detection with alert
- Editable Channel Name
- 10 Brightness and Contrast settings
- Optional Raymic Second Station Handset
- Optional external speakers for both transceiver and Raymic stations

Digital Selective Calling (DSC)

The Ray218E and Ray55E include equipment for Class "D" Digital Selective Calling (DSC). DSC protocol is a globally applied system used to send and receive digital calls. DSC uses a unique Maritime Mobile Service Identity (MMSI) number to direct DSC calls directly to your radio, much like a telephone number. Most importantly, DSC enables digital distress calls that automatically notify other ships and shore stations where you are and that you are in a distress situation.

Note: *An MMSI ID number is required to operate the DSC equipment in this radio. You can request an MMSI number from the same agency that issues radio or Ship Radio licenses in your area. Once obtained, you can program the MMSI number yourself one time only using the menu operation described in "My MMSI ID" on page 96.*

The Ray218E and Ray55E include the following DSC features:

- Separate receiver dedicated to handling DSC Calls on channel 70
- Position Request function sends GPS position data to or receives position data from other stations
- Phonebook for automatically making DSC calls
- Quick Call feature sends Individual Calls or Group Calls directly from the phonebook, just like the redial function on a telephone
- Five Group IDs for making DSC Calls only to stations in your group, such as a flotilla or fishing fleet

DSC functions are fully described in Chapter 5.

Chapter 2: Installation

2.1 Unpacking and Inspection

Use care when unpacking the unit from the shipping carton to prevent damage to the contents. It is also good practice to save the carton and the interior packing material in the event you must return the unit to the factory.

Removing the Sun Cover

The Sun Cover was designed to remain attached to the radio, even in rough seas.

To remove the Sun Cover:

1. Place your thumb in the dimple and push downward.
2. At the same time, pull up the lift tab with your index finger.
3. Pinch your fingers towards each other as you lift up.

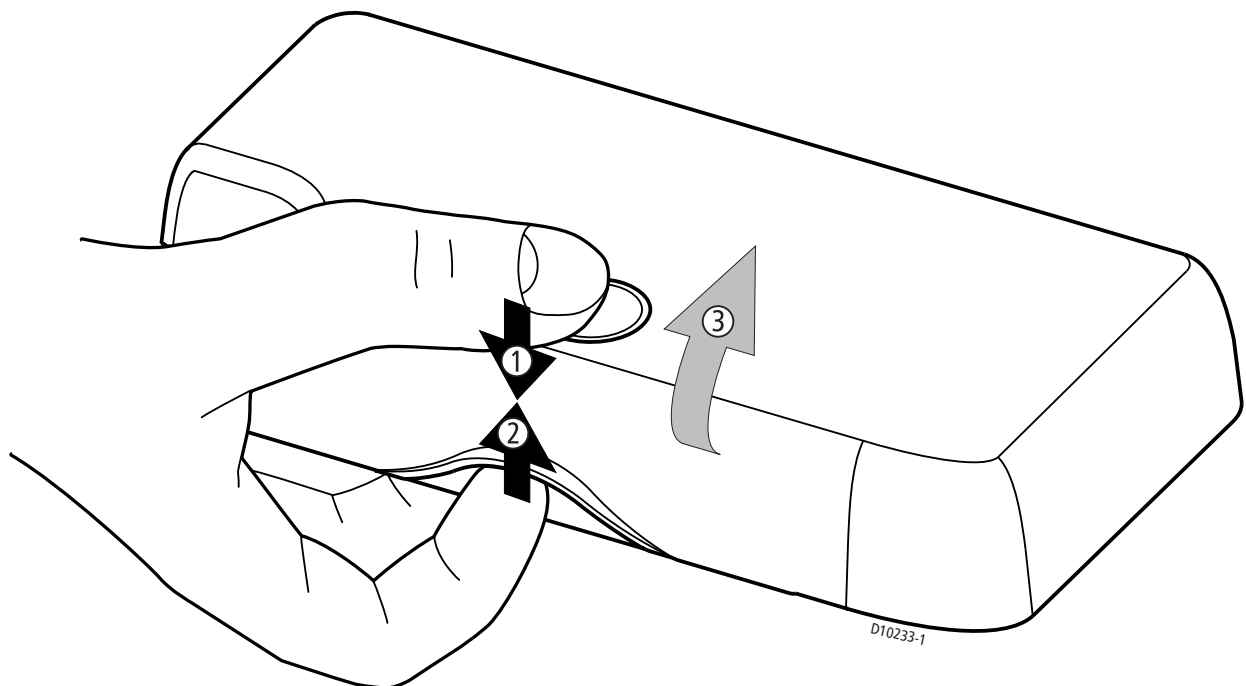

Equipment Supplied

The following is a list of materials supplied with the Ray218E and Ray55E:

Part No	Description
E43033	Ray218E VHF Radio with removable microphone
R49163	Sun Cover
R49164	Mounting Bracket
R49165	Bracket Knob for Ray218E/Ray55E/Ray49E
R49172	Microphone
R49166	Microphone Hanger for Ray218E/Ray55E/Ray49E
R49241	Power Cord for Ray218E/Ray55E/Ray49E
R49168	NMEA/Speaker/Hailer Cable
81279	Handbook for Ray218E/Ray55E Screws (x5) for Mounting Bracket/Microphone Hanger Screw/Lock Washer (x1) for Grounding
E43037	Ray55E VHF Radio with integral microphone
R49170	Sun Cover
R49169	Mounting Bracket
R49165	Bracket Knob for Ray218E/Ray55E/Ray49E
R49166	Microphone Hanger for Ray218E/Ray55E
R49167	Power Cord for Ray218E/Ray55E/Ray49E
81279	Handbook for Ray218E/Ray55E Screws (x5) for Mounting Bracket/Microphone Hanger Screw/Lock Washer (x1) for Grounding

The following is a list of optional equipment:

Part No	Description
A46052	Raymic Second Station for Ray218E/Ray55E
A46055	Raymic Extension Cable, 5m*
A46056	Raymic Extension Cable, 10m*
A46054	Microphone Relocation Kit for Ray218E/Ray55E
A46053	Rear Flush Mount Kit for Ray218E/Ray55E
A46060	Front Flush Mount Kit for Ray218E
E46006	10W External Speaker
M95435	Hailer Horn Speaker

* Maximum total Raymic extension cable length must not exceed 20 meters

2.2 Planning the Installation

Mount the transceiver to allow easy access from the location where the boat is normally navigated. Select a location that is non-metallic, dry, protected, well-ventilated, and free from high operating temperatures and excessive vibration. Provide sufficient space behind the transceiver to allow for proper cable connections to the rear panel connectors. Locate the transceiver as near as possible to the power source yet as far apart as possible from any devices that may cause interference such as motors, generators, and other on board electronics. The radio should be protected from prolonged direct exposure to rain and salt spray.

The Ray218E/Ray55E is not designed to be mounted in engine compartments. Do not install the radio in a location where there may be flammable vapors (such as in an engine room or compartment, or in a fuel tank bay), water splash or spray from bilges or hatches, where it is at risk from physical damage from heavy items (such as hatch covers, tool boxes, etc.), or where it might be covered by other equipment. Locate the radio at least 1.5 meters from the antenna.

Safe Compass Distance is 1 meter for a common compass. To be sure, you should locate the radio as far as possible from the compass. Test your compass to verify proper operation while the radio is also operating.

The Ray218E/Ray55E can be conveniently mounted on a chart table, bulkhead, overhead, or any other desired location. Refer to the following figure for typical mounting methods.

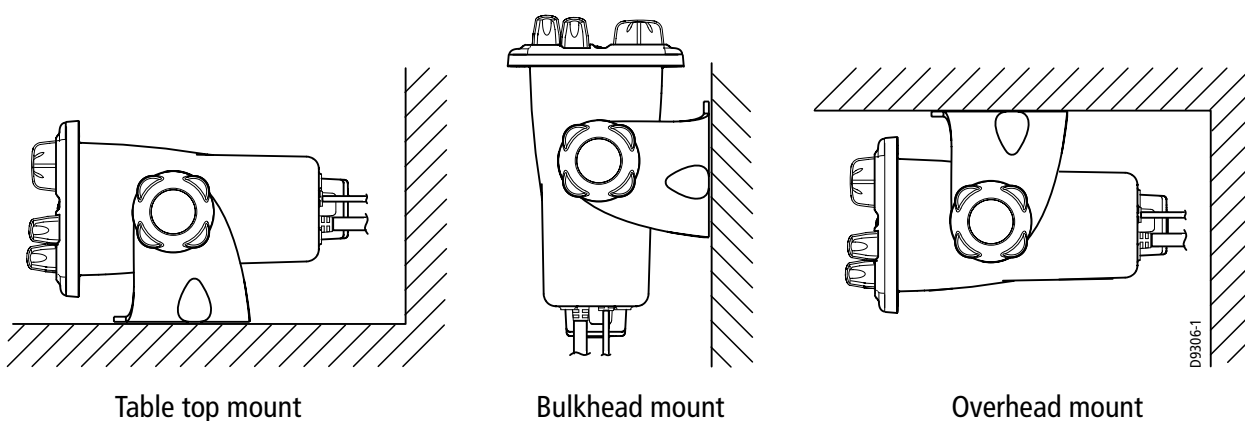

The Ray218E/Ray55E may also be flush mounted using the optional A46053 Rear Flush Mount Kit, available from your Raymarine dealer. A Front Mount Kit (part number A 46060) is also available for the Ray218E. Instructions for installing the radio using the Flush Mount Kit are included with the kit.

Ray218E Dimensions

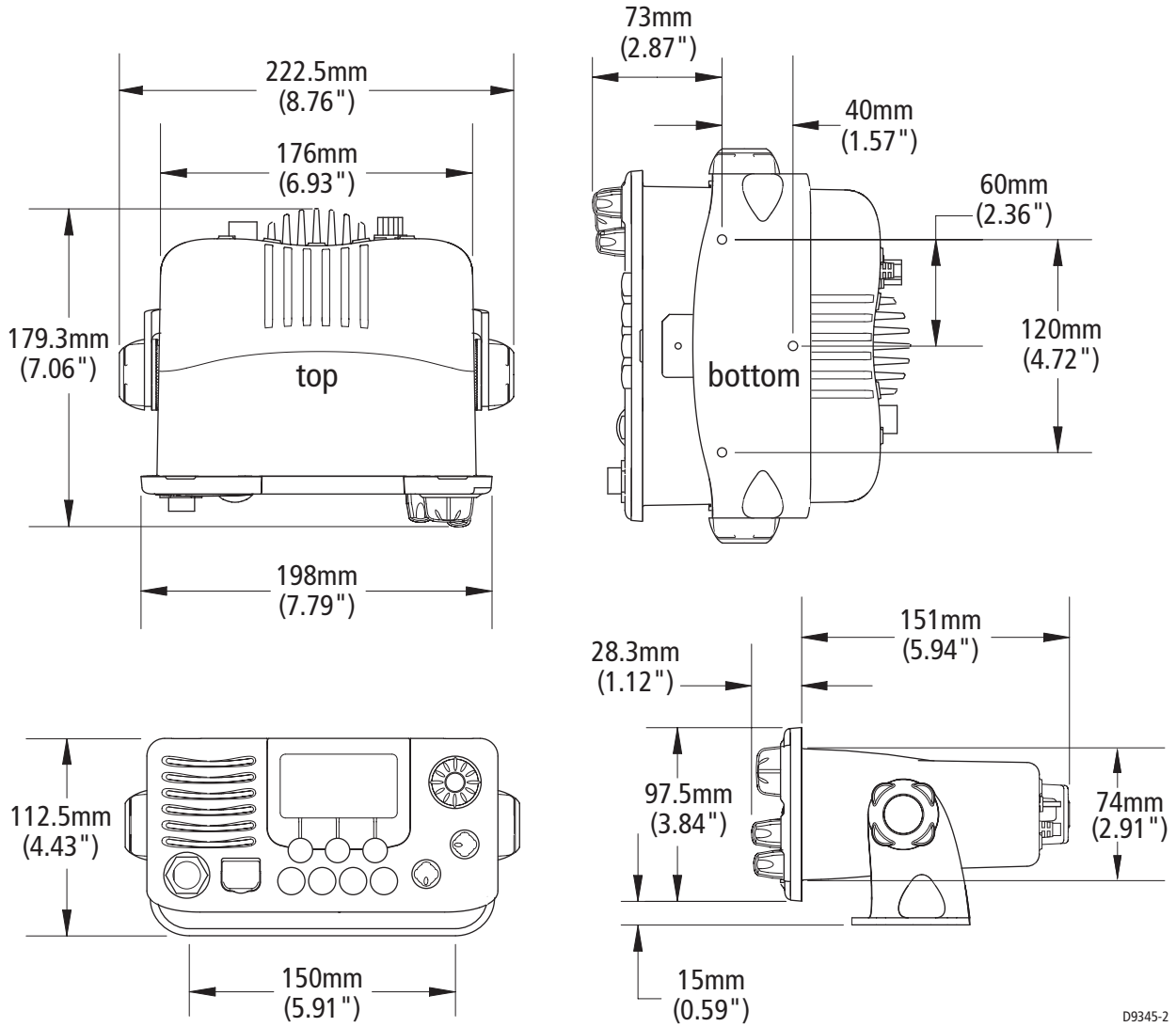

D9345-2

Ray55E Dimensions

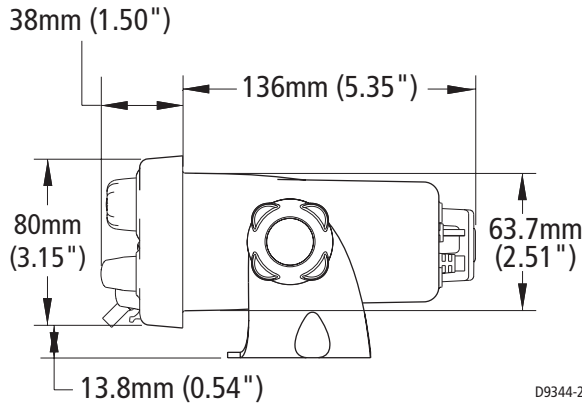
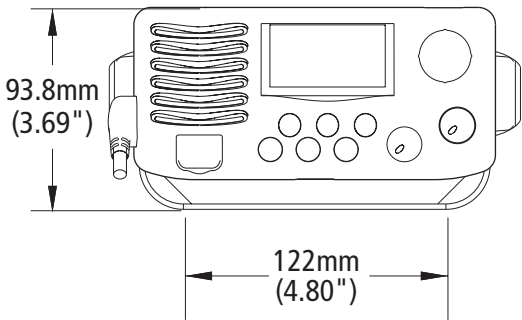
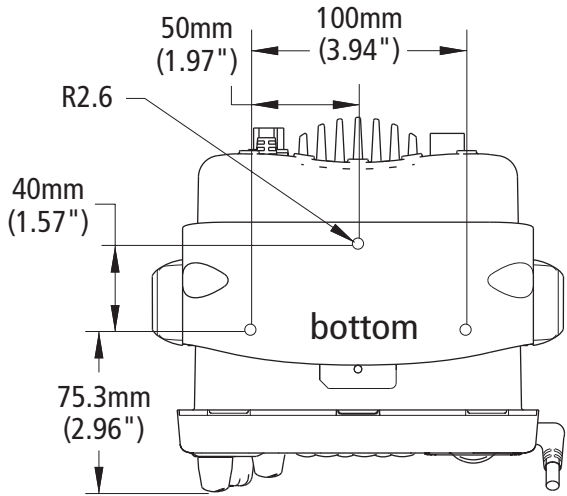
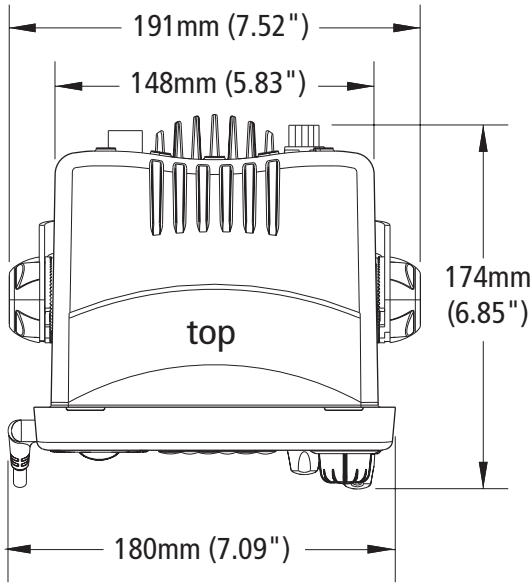

D9344-2

2.3 Cable Connections

The radio has bullet connectors for power and cable connectors for attaching the optional Raymic or Microphone Relocation Kit. The remaining wires are for attaching NMEA, an optional external speaker, and an optional a hailer horn (Ray218E only). The Ray218E has a single cable with mating connectors for this purpose; the Ray55E has individual wire pairs. In either case, connect the wires as shown in the following table. Other connections are discussed in the ensuing sections.

Color	Signal	Connects to
Gray Purple	NMEA IN + NMEA IN –	GPS
Blue Brown	NMEA OUT + NMEA OUT –	Chartplotter display unit (E Series, C Series, etc.)
Yellow Green	SPEAKER + SPEAKER –	Optional remote speaker, Raymarine part no. E46006
White Black	HAILER + HAILER –	Optional horn speaker, Raymarine part no. M95435 (Ray218E only)

Make cable connections as shown in the following figures.

Ray218E Rear Connections

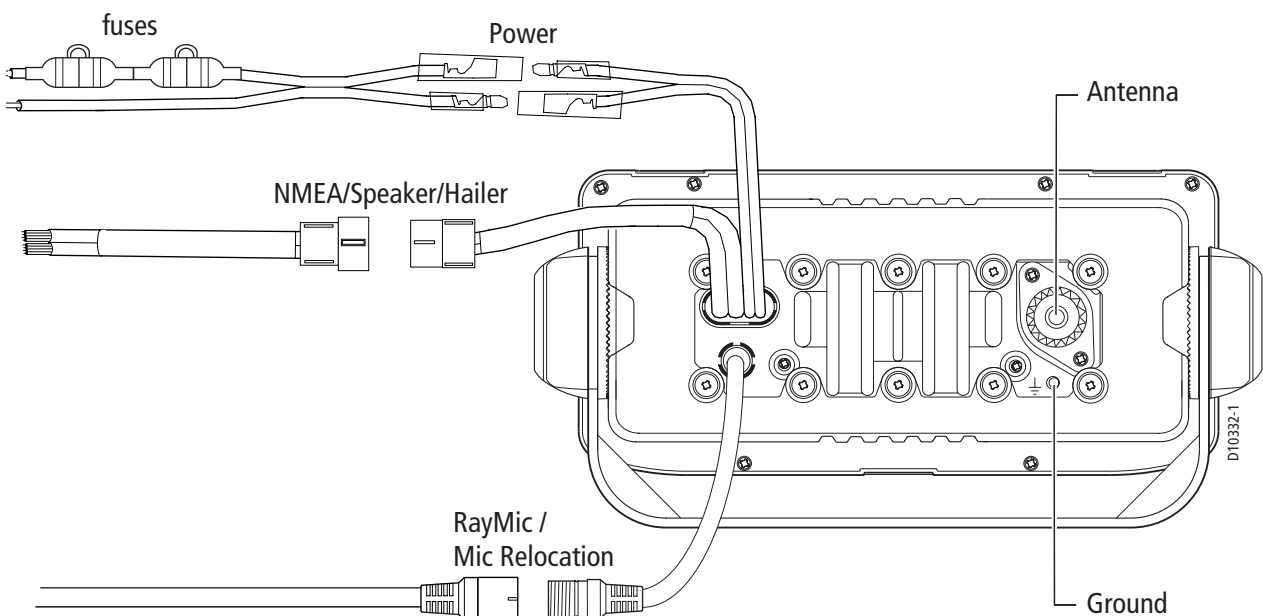

Ray55E Rear Connections

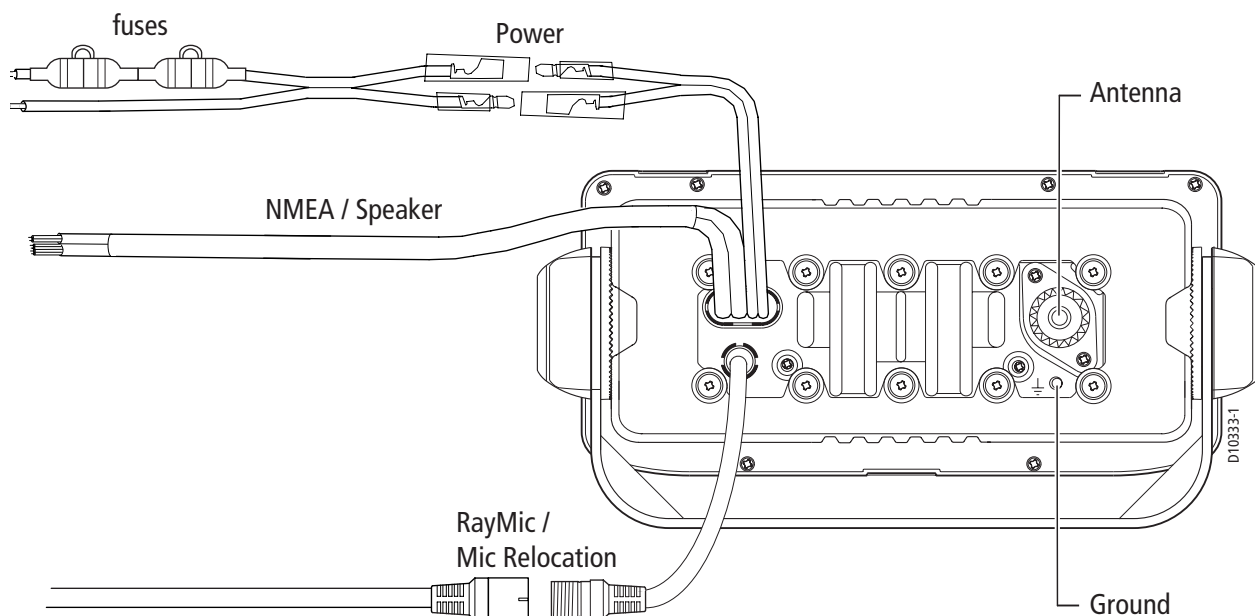



The ends of all wires are clipped at the factory so that no bare metal is exposed. You must strip back the insulation before installation. If you are not connecting a wire or set of wires (SPEAKER, for example), leave them insulated. If you have stripped back a wire that you will not be connecting, clip the bare wire down to the insulation.

Power

The red and black Power Cord provides connection to DC power. Slide the bullet connectors on the cord into their mates (with the same colored wire) on the rear of the radio. Connect the stripped wires on the Power Cord to the nearest primary source of the boat's DC power. A suitable source would be a circuit breaker on the power panel or a fuse block near the unit, rated at 10 amps. The red (+) wire contains 2 in-line fuses rated at 10A, 250V, slow-blow each. Connect it to the positive terminal of the power source. Connect the black (–) wire to the negative (ground) of the power source. If a fuse ever needs to be replaced, be sure to use the same type and rating.

The power cord must be long enough to reach the DC power source. If additional wire length is required, the cable can be extended by adding more cable as necessary. However, for power cable runs longer than 15 feet, larger wire diameter size should be used to prevent voltage line loss. To ensure adequate current draw to the equipment, Raymarine recommends that you use lugs to connect the power cable to the DC supply and that the lug connections be both crimped and soldered.

The Ray218E/Ray55E is designed for a 12 volt (nominal) system. If battery voltage drops below 10.5 VDC, the  LOW icon appears on the LCD. Discontinue using the radio if a low voltage condition occurs as performance would be unreliable. If voltage increases to 15.8 VDC,  HIGH appears. If voltage exceeds 18.5 VDC, the unit automatically shuts down to prevent damage.

Hailer Horn (Ray218E only)

Connect the white (+) wire and black (–) wire to the hailer horn observing polarity as it is marked on the speaker.

The HAILER – wire is the same color as the POWER – wire (black). Ensure that black HAILER – wire is NOT connected to ground or to the negative terminal of the boat’s battery.

Note: *To avoid feedback, mount the horn so that it is facing away from the microphone and is located at least 3 meters (10 feet) from the microphone.*

External Speaker

Connect the yellow (+) wire and green (–) wire from the radio to the same colored wires on the E46006 External Speaker. Be sure to insulate exposed bare ends.

Note: *You can connect separate external speakers to the transceiver and to the optional Raymic second station.*

Raymic / Mic Relocation

The radio has cable connectors for attaching either the optional A4605Raymic or the A46054 Microphone Relocation Kit for mounting the microphone in a remote location. Align the arrows on both connector ends and mate.

Raymic Extension cables are available from your Raymarine dealer in 5 meter (part no. A46055) and 10 meter (part no. A46056) lengths. Maximum total Raymic extension cable length must not exceed 20 meters.

You can also install an optional E46006 external speaker to the Raymic. Connect the yellow (+) wire and green (–) wire from the E46006 External Speaker to the same colored wires emanating from the pigtail at the Raymic end of the extension cable. See the following figure.

Note: *You can connect separate external speakers to the transceiver and to the optional Raymic second station.*

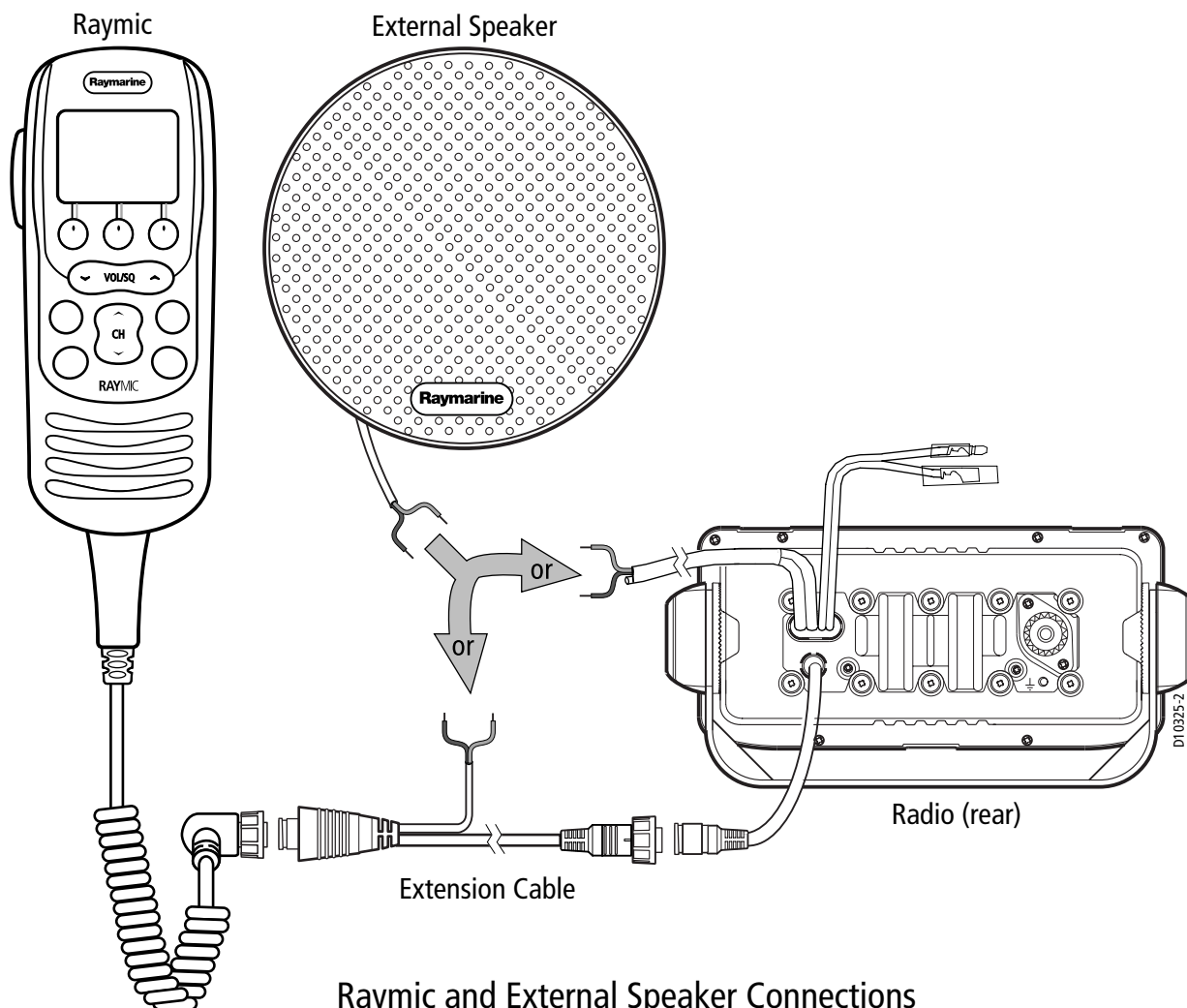

Raymic and External Speaker Connections

NMEA Data

The Ray218E/Ray55E accepts NMEA 0183 (V3.01) data from a position determining device (GPS) to provide the Latitude and Longitude position information. This information appears on the radio's LCD display and is also transmitted during a DSC Distress Call. When a valid NMEA signal is detected, the GPS satellite indicator appears solid on the LCD. When no NMEA signal is detected, the GPS satellite indicator blinks.

When Distress Call and Position (lat/lon) information is received from other stations, your Ray218E/Ray55E also has the capability of outputting the vessel's position to your chartplotter display unit (C Series, E Series, etc.) over the NMEA port so that it can be displayed on the screen. See "NMEA Output" on page 61.



NMEA IN (from GPS)

Connect the NMEA OUT + and NMEA OUT – signals from the positioning device to the NMEA IN + (gray) and NMEA IN – (purple) wires, respectively, from the radio. An example of how to make the connections using a suitable connector block is shown in the following drawing. For specific instructions how to connect your particular GPS, please refer to the handbook that came with that device.

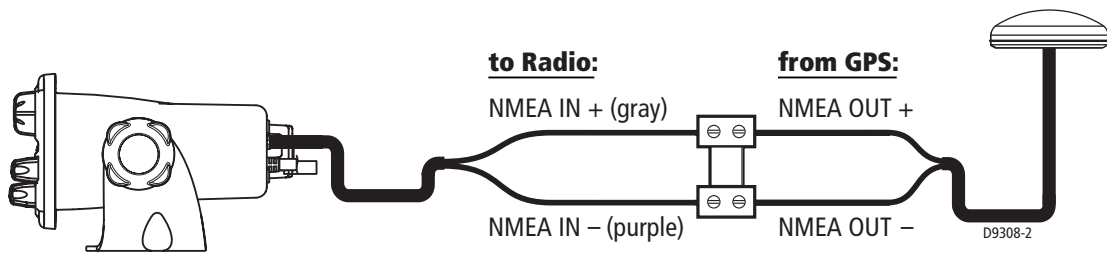

NMEA Alarm

When no valid position data is available, the NMEA alarm sounds (provided that the MMSI number has been programmed): the GPS satellite icon flashes and NO POS DATA is displayed on the dot matrix display. The alert tone sounds for 5 seconds or until you acknowledge it by pressing any key. The alarm repeats every four hours, as long as the condition exists.

If desired, you can manually enter time and position data using the GPS/Time Setup feature, as described on page 58. The alert repeats every four hours as long as no position information has been entered manually. If position data is entered manually but has not been updated during the previous 23.5 hours, all the position (lat/lon) fields are set to all 9's, time field is set to all 8's, and the display reverts to NO POS DATA.

NMEA OUT (to Chartplotter Display)

Connect the NMEA IN + and NMEA IN – signals from the chartplotter display to the NMEA OUT + (blue) and NMEA OUT – (brown) wires, respectively, from the radio. An example of how to make the connections using a suitable connector block is shown in the following drawing. For specific instructions how to connect your particular display, please refer to the handbook that came with that device.

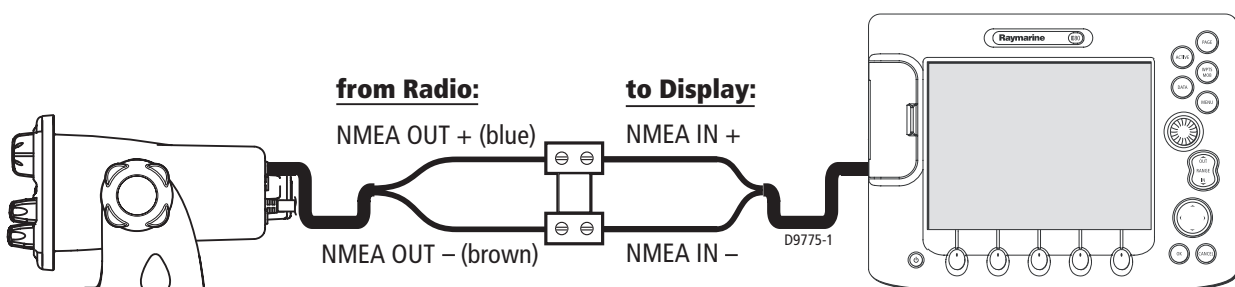

Antenna

Raymarine recommends that you install a VHF Marine band antenna with a minimum height of 8 ft. and gain of at least 6 dB.

The coaxial VHF antenna cable connects to the Ray218E/Ray55E antenna jack on the rear panel using a PL-259 VHF type connector. The antenna cable length can be critical to performance. If you are uncertain, contact a professional installer or call Raymarine Product Support. If a longer cable length is required, RG-8x (50 ohm) marine coaxial cable or equivalent cable can be used for runs up to a maximum of 50 feet. If the distance required is even greater, Raymarine recommends using low loss RG-213 or equivalent cable for the entire run to avoid excessive losses in power output.

If the antenna RF connector is likely to be exposed to the marine environment, a protective coating of silicon grease (Dow Corning DC-4 or similar) can be applied to the connector before connecting it to the radio. Any other extensions or adapters in the cable run should also be protected by grease and then wrapped with a waterproofing tape.

Antenna Mounting Suggestions

Mounting the VHF antenna properly is very important because it will directly affect the performance of your VHF radio. Use a VHF antenna designed for marine vessels. Since VHF transmission is essentially line-of-sight, mount the antenna at a location on the vessel that is free of obstruction to obtain maximum range.

If you must extend the length of the coaxial cable between the antenna and the radio, use a coaxial cable designed for the least amount of power loss over the entire cable length.

For optimal radio performance and minimal human exposure to radio frequency electromagnetic energy, make sure the antenna is:

- mounted as high as possible, but at least located at least 1.5 meters (5 feet) from the radio
- connected to the radio before transmitting
- located where it will be away from people

WARNING: Antenna Mounting and EME Exposure

Ensure that the antenna is mounted so that no one can enter the maximum permissible exposure radius for RF radiation. See the Safety Notice entitled "Antenna Mounting and EME Exposure" on page 11.

Grounding

While special grounding is not required, it is good marine practice to properly ground all electronic equipment to the boat's earth ground system. The Ray218E/Ray55E can be connected to ground by installing the supplied screw and lock washer into the threaded hole labelled with the \perp icon, located on the transceiver's rear panel, adjacent to the antenna jack. Then attach a #10 AWG wire from this screw to the nearest ship's earth ground connection point.

CAUTION: Ground Connection

Do not connect this ground connection to the negative terminal of the battery.

Chapter 3: General Operations

3.1 Keypad and Rotary Knobs

Several of the keys on the front panel of the transceiver serve multiple purposes. For the most part, the function indicated on the first line of the key is accessed by pressing that key for fewer than 3 seconds and then releasing it. The function indicated on the second line of the key is accessed by pressing and holding the key for greater than 3 seconds.

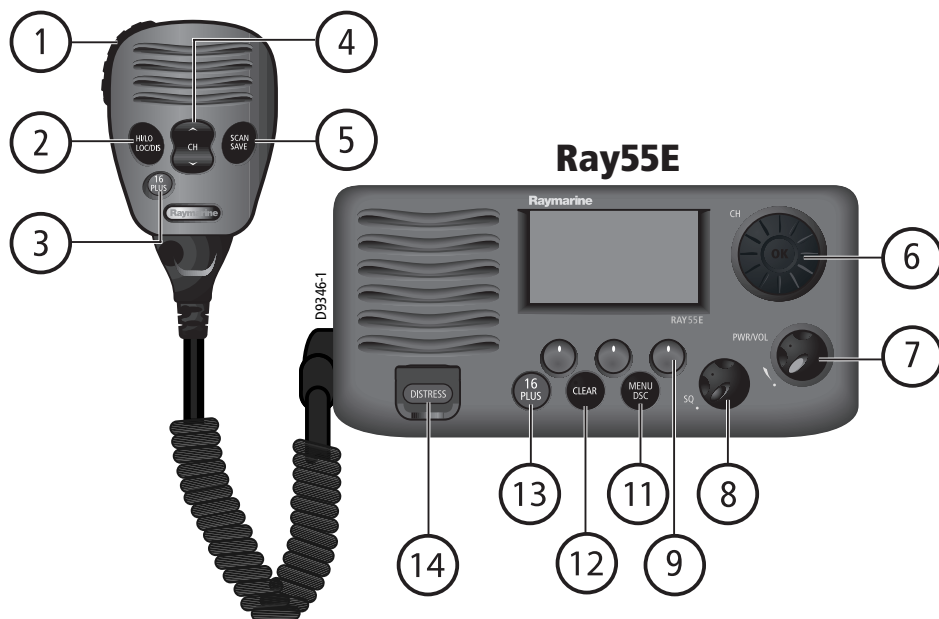
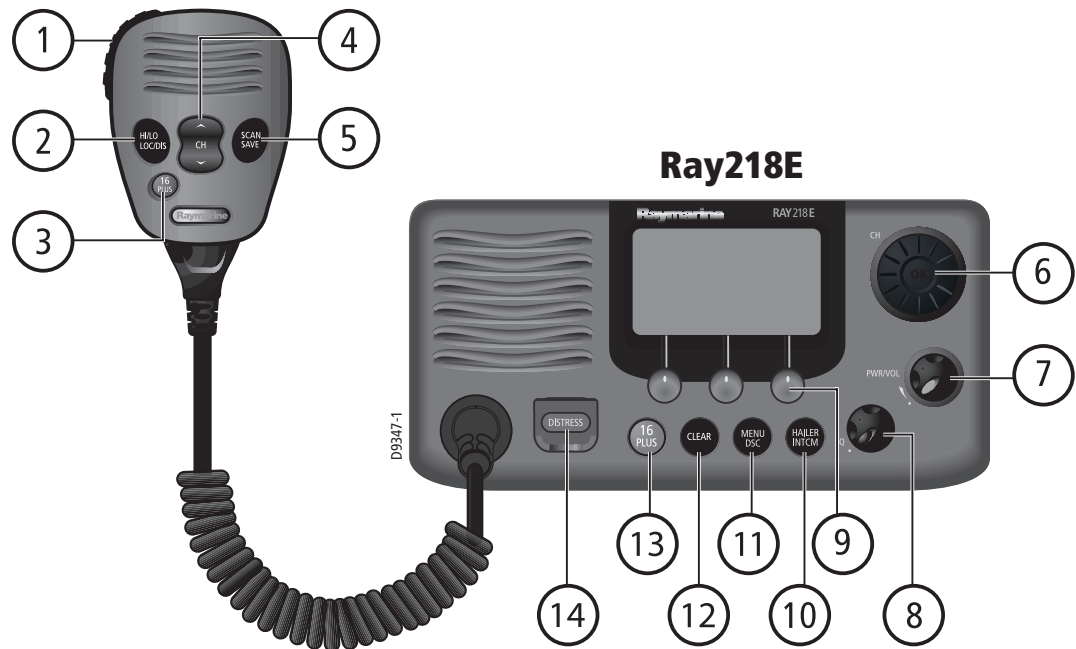

Microphone Keys



1. PTT

Press this Push-to-Talk key to transmit.



2. HILO / LOC DIST

Press and release to toggle the transmit power from HI to LO. Can also be used to select items in menu mode. Press and hold for to toggle between full receiver sensitivity (Distant mode) and attenuated receiver sensitivity (Local mode).



3. 16/PLUS

Use this key to switch to the priority channel or to change the value of the Secondary Priority (PLUS) Channel.



4. UP/DOWN

Use the arrow keys to change the active channel number. Press and hold for rapid channel changing. Can also be used to scroll through selections in menu and programming modes.



5. SCAN / SAVE

Press and release this key to access the Scan Mode menu, which is described on page 44. If Scan Mode is active, pressing this key terminates the scan. Press and hold for 3 seconds to enter a channel into the radio's memory. This function is described in "Saving Channels to Memory" on page 49.

Transceiver Controls

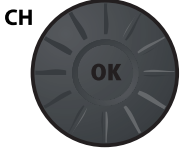

6. CH/OK

Rotate this knob to change the current channel number and to change values in Menu mode or during programming. Press in to enter values selected in Menu mode or during programming.



7. PWR/VOL

Use this knob to turn the radio ON and OFF and to set the volume.

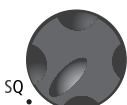

8. SQ

Use this knob to set the squelch threshold, which cuts off the receiver when the signal is too weak for reception of anything but noise.



9. Soft Keys

These multifunction keys change according to context, such as to navigate through menus or to make menu selections. Press to select the corresponding function as identified by the on-screen label.

Transceiver Push Keys



10. HAILER / INTCM (Ray218E only)

Press and release to access the hailer horn to make voice announcements or sound various fog horn tones. Press and hold for 3 seconds to use the intercom feature to communicate with a secondary station. Requires an optional Raymic second station.

This key is only available with the Ray218E.



11. MENU/DSC

Press and release this key to select Menu Mode, which is used to set up the radio. Menu operations are fully described in Chapter 4.

Press and hold for 3 seconds to enter DSC Call Mode, which is used for making DSC Calls and viewing the DSC Call Logs and the DSC Call Phonebook.

A Maritime Mobile Service Identity (MMSI) number is required to operate the DSC equipment in this radio. This number directs DSC calls directly to your radio, much like a telephone number. You can program the MMSI number yourself one time only using the operation described in "My MMSI ID" on page 96. Otherwise, your Raymarine dealer can program or change the number for you.

Full details on DSC call operation are described in Chapter 5.



12. CLEAR

Press and release to terminate a function and return to the last-used channel. Press and hold for 3 seconds to select the Weather mode (if available).



13. 16/PLUS

Use this key to switch to the priority channel or to change the value of the Secondary Priority (PLUS) Channel.



14. DISTRESS

Push up the spring-loaded cover and press this key to make a DSC Distress Call. Instructions for making a Distress Call are described in Section 5.2.

Optional Raymic Second Station

The optional Raymic Handset provides the Ray218E/Ray55E with a second station in a telephone handset design. The Raymic, which attaches to the handset connector on the rear of the radio, enables intercom capabilities with the transceiver from a remote portion of the vessel. Intercom functions are discussed on page 57.



A. PTT

Press this Push-to-Talk key to transmit.



B. VOL/SQ

By default, these keys control earpiece speaker volume. Press the up arrow key to increase or the down arrow to decrease the volume.

Press and release the center key to activate the squelch threshold adjustment.

Then, press up arrow key to increase or down arrow to decrease the squelch level.



C. CLEAR

Press and release to terminate a function and return to the last-used channel. Press and hold for 3 seconds to select the Weather mode (if available).



D. 16/PLUS

Press and release this key to switch between the Priority Channel 16 and the current working channel.

Press and hold for 3 seconds to tune to the Secondary Priority (PLUS) Channel, which defaults to 9.

If already tuned to the Secondary Priority (PLUS) Channel, press and hold for 3 seconds to program a new Secondary Priority (PLUS) Channel.



E. Soft Keys

These multifunction keys change according to context, such as to navigate through menus or to make menu selections. Press to select the corresponding function as identified by the on-screen label.



F. MENU / DSC

Press and release this key to select Menu Mode, which is used to set up the radio. The menu structure is outlined in the following drawing. Menu operations are fully described in Chapter 4.

Press and hold for 3 seconds to enter DSC Call Mode, which is used for making DSC Calls and viewing the DSC Call Logs and the DSC Call Phonebook.



G. CH

Use the arrow keys to change the active channel number. Press and hold for rapid channel changing. Can also be used to scroll through selections in menu and programming modes.



H. OK / INTCM

Press and release this key to enter values selected in Menu mode or during programming. Press and hold for 3 seconds to enable the intercom feature for communications between the transceiver and Raymic second station. Intercom functions are discussed on page 57.

3.2 Transceiver LCD

The following describes the function of the characters on the radio's LCD.

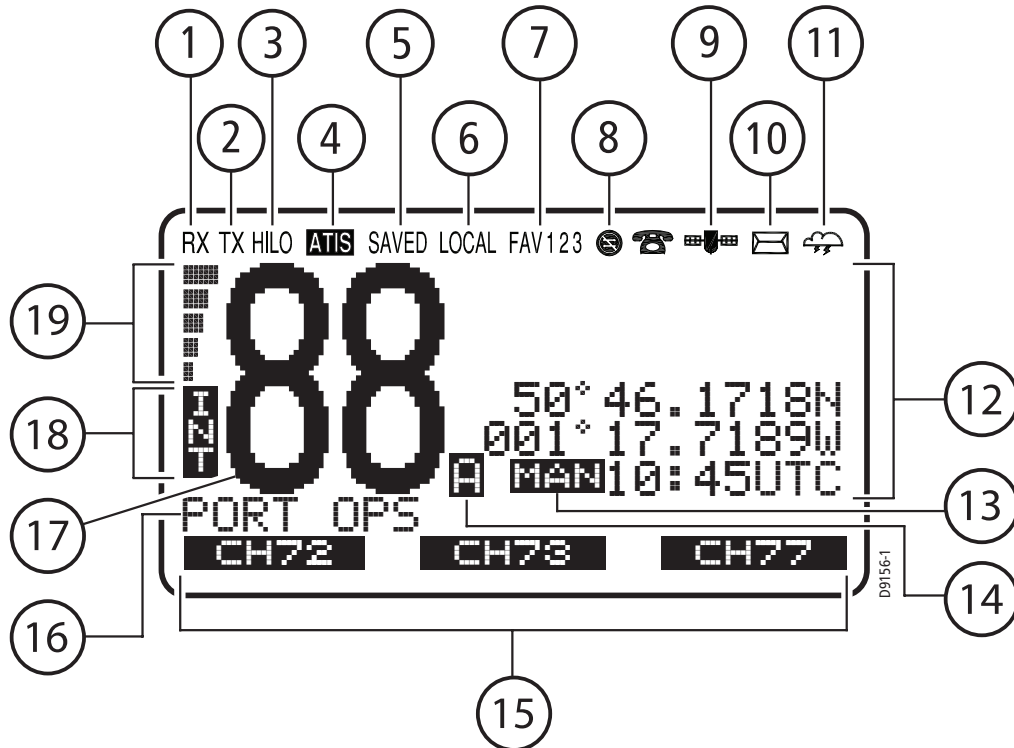

1. (RX) Receiving

Indicates that the radio is receiving a radio signal.

2. (TX) Transmitting

Indicates the **PTT** key is being pressed and the radio is transmitting.

3. (HI/LO) TX Power

Indicates whether transmit power is set for 25 watts (HI) or 1 watt (LO).

4. ATIS Active

Indicates ATIS transmission is enabled. Only available in European countries using the International channel set.

5. (SAVED) Memory Mode

Indicates the current channel has been saved in memory. Appears during Saved (Memory) Scan and Priority Saved Scan modes.

6. (LOCAL) Local/Distant Mode

Indicates the radio is in Local Reception mode, which decreases receiver sensitivity in high traffic areas to decrease unwanted reception.

7. (FAV123) Favorite Channel

Indicates which of the three (3) Favorite Channel banks is currently selected. Each bank displays a different favorite channel that you have assigned for each of the 3 soft key labels at the bottom of the LCD. This gives you a total of 9 favorite channels that you can jump to at the press of a key.

8. Automatic Channel Changing Blocked

Indicates that your radio will not automatically switch to the channel requested by an incoming DSC call but rather will prompt you to manually accept or decline the channel change request. Applies to Distress and All Ships Urgency calls only. This feature is controlled by the DSC Setup menu item AUTO CH CHG described on page 98. By default, this icon is off, meaning that auto channel changing is active.

9. GPS

Indicates that positional data is available from your GPS.

10. DSC Call

When flashing, indicates that the radio has received a DSC Call. Details of the call can be viewed in the associated log. See "Received Calls (Logs)" on page 94. The icon disappears when the call is accepted, the call is rejected, or the associated message is viewed in the log.

11. Weather Alert

Indicates that the radio is monitoring for weather alert broadcasts. US and Canada only.

12. Dot Matrix Display

Indicates radio functions, GPS position data or special conditions, depending on the situation. The screen is different when sending/receiving a DSC Call (see Chapter 5) or setting up a Menu item (see Chapter 4).

13. (MAN) Manual Position Data

Indicates position data is not from GPS but rather has been entered manually.

14. Channel Status

A subscript character following the channel number indicates special qualities.

(A) Simplex Channel

The subscript **A** indicates that the currently-selected US or Canadian channel is simplex, although its International counterpart is semi-duplex (5A, for example). This channel uses the transmit frequency of the International channel for both transmitting and receiving. If a channel is simplex in all 3 channel sets (US, Canadian, and International—channel 6, for example), the **A** does not appear.

Note: *Simplex means that the radio transmits and receives on the same frequency for this channel. Semi-duplex channels use separate frequencies to transmit and receive.*

(B) Receive-only Channel

The subscript **B** indicates that you cannot transmit on the currently-selected channel; it is receive-only. Used with Canadian channels only.

15. Soft Key Labels

Displays the current function of the associated soft key.

16. Channel Name

Displays the current channel name. This field is editable.

17. Channel Number

Displays the current active channel number.

18. Channel Set

Indicates which channel set is selected: USA, INT (International), CAN (Canadian), or WX (Weather).

Note: *Special licensing is required to receive the US and Canadian channel sets.*



19. Signal Strength

Indicates that the relative strength of the radio signal being received. Displays between 0 (no signal) and 5 (strongest signal) bars.

Display Mode

The Ray218E/Ray55E has an alternative method for displaying the channel number than the one demonstrated above: 2 UP mode. In 2 UP mode, you are presented with the currently-active channel on the left and the standby channel on the right. 2 UP mode is discussed in "Display Mode" on page 47.

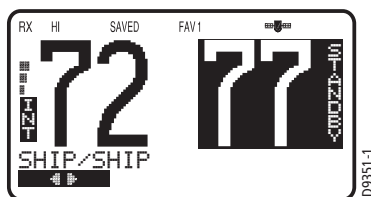

3.3 Alert Messages

The radio has several warning messages to alert you to special conditions.

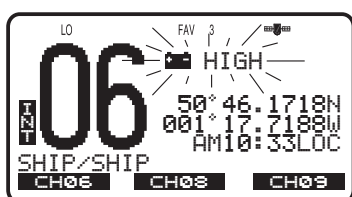

Battery Voltage High

Indicates boat's battery voltage exceeds 15.8 VDC (typical). If voltage exceeds 18.5 volts (typical), the radio powers itself off to prevent equipment damage.

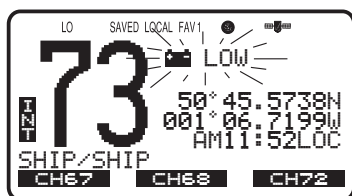

Battery Voltage Low

Indicates boat's battery voltage is below 10.5 VDC (typical), which is the lowest voltage at which the radio can be reliably operated.

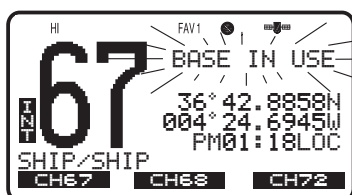

Base in Use

Indicates that the base station (transceiver) is in use and has priority. Only appears on a Raymic second station when the transceiver is already in use.

3.4 Turning the Power ON and OFF



Turn the **PWR/VOL** knob clockwise until it clicks. When the unit powers up in standby mode it:

- Beeps, illuminates the backlight at full brightness, and displays a self-test.
- Recalls the last channel number, TX power settings and operation mode. If no last-used setting data exists, goes to channel 16 and high TX Power.
- When GPS Data is available, extended position data is displayed with the offset time. This information will be displayed when display option for the position and time is enabled on the Menu. See Section 4.4.
- When the MMSI number is not programmed, you are prompted to enter the number as described on page 96. You must then press OK to continue.

To turn the unit OFF, rotate the **PWR/VOL** knob completely counter clockwise until it clicks.

3.5 Setting the Volume



...on the Transceiver

Adjust the **PWR/VOL** knob to control the loudspeaker volume level. Turn clockwise to increase the volume; counter clockwise to decrease the volume.

...on the optional Raymic



Press the up arrow on the **VOL/SQ** key to increase or the down arrow to decrease the volume level.

3.6 Setting the Squelch

The squelch circuit sets the threshold for cutting off the receiver when the signal is too weak for reception of anything but noise.



...on the Transceiver

To properly set the squelch, rotate the **SQ** knob counter clockwise until audio is heard. Then rotate clockwise until background noise disappears.

...on the optional Raymic



Press and release the center of the **VOL/SQ** key to activate squelch threshold level adjustment. Press the down arrow key until audio is heard. Then press the up arrow until background noise disappears.

3.7 Tuning the Channel

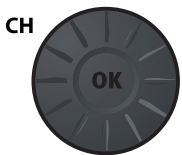

...on the Transceiver

Rotate the **CH/OK** knob clockwise to increase the channel number.

Rotate the **CH/OK** knob counter clockwise to decrease the channel number.



...on the optional Raymic

Press and release the UP arrow to increase the channel number.

Press and release the DOWN arrow to decrease the channel.

Press and hold either key for rapid channel scrolling.

3.8 Selecting a Weather Channel (If Licensed)

CLEAR

The US National Oceanic and Atmospheric Administration (NOAA) broadcasts continuous weather reports and severe weather alerts, as needed. If so equipped, your Ray218E/Ray55E is programmed to receive 10 weather channels and sound an alarm if a weather alert is received.

To enter Weather mode, press and hold the **CLEAR** key for 3 seconds on either the transceiver or the Raymic.

PRESS and HOLD for 3 secs

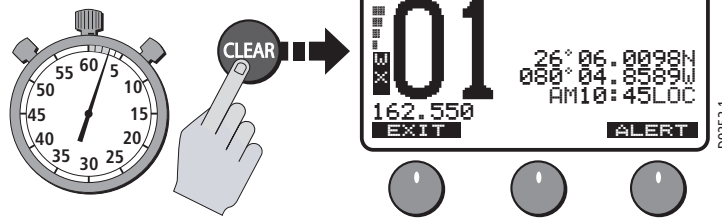

The weather function soft keys appear and the WX indicator appears in the channel set field. Rotate the **CH/OK** knob on the transceiver or use the channel up/down keys on the Raymic to select from channels WX01 through WX10.

Press and release the **CLEAR** key again to return to normal operation.

Note:

1. WX broadcasts can only be heard in the US and Canada.
2. The Ray218E/Ray55E can receive these broadcasts only if the unit has been upgraded by the distributor to use WX Channels.
3. During Weather mode, the PTT, HI/LO, and SCAN/SAVE keys are disabled and an error beep sounds if pressed.

Weather Alert Operation (If Available)

NOAA also broadcasts continuous severe weather alerts as needed. You can set your Ray218E/Ray55E to notify you when such an alert is issued. To enable the Weather Alert, press the ALERT soft key. The cloud icon appears.

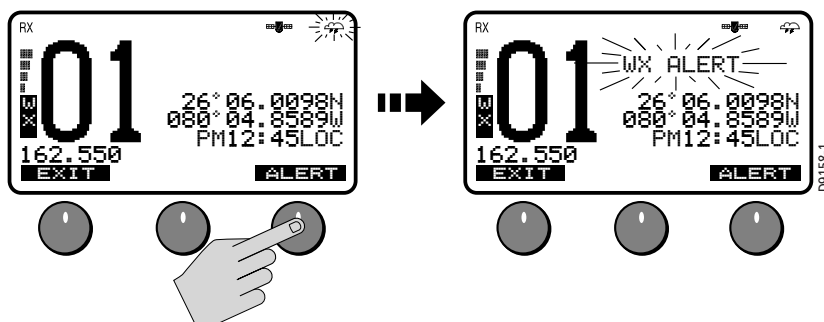

When the severe weather alert tone is detected, the message WX ALERT is displayed and an alarm sounds. The radio automatically tunes to the WX channel where the weather alert has been detected. The alert is detected in all modes of operation (Standby, Dual Watch, Tri Watch, Scan, etc.)

Note: *The Ray218E/Ray55E can receive weather alert broadcasts in the US or Canada only if the unit has been programmed by the distributor to use WX Channels.*

3.9 Selecting the Priority Channel

16
PLUS

The Ray218E/Ray55E provides you with a dedicated key for switching to the Priority Channel 16. Press and release the **16/PLUS** key to switch to channel 16 at high power. The label 1ST PRIORITY appears. If already on channel 16, press and release **16/PLUS** to return to the last-used working channel.

The **16/PLUS** key also can be used to cancel all other modes and switch to channel 16.

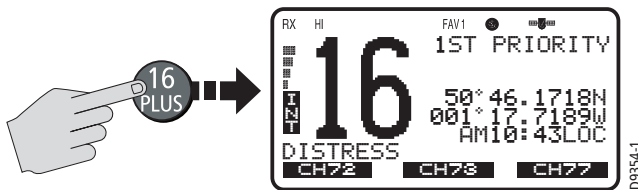

Note: *When the priority channel is selected, the radio is always set to HIGH transmit power. You may reduce power if desired using the HI/LO power setting.*

3.10 Selecting the Secondary Priority (PLUS) Channel

16
PLUS

The Ray218E/Ray55E enables you to program the **16/PLUS** key to store a Secondary Priority (PLUS) Channel. The default is channel 9. If on Primary Priority channel 16 or a working channel, press and hold the **16/PLUS** for 3 seconds to switch to the Secondary Priority (PLUS) Channel at high power. The label 2ND PRIORITY appears. The default is channel 9.

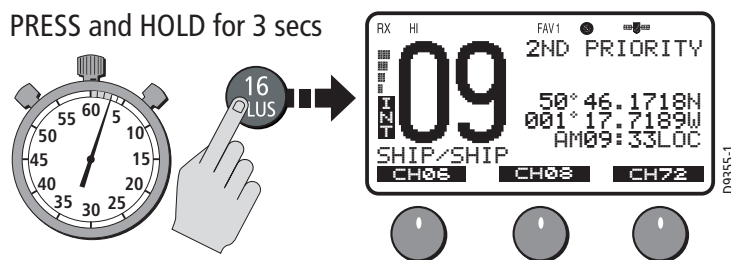

If already tuned to the Secondary Priority (PLUS) Channel, press and release the **16/PLUS** key to switch to Priority Channel 16 at high power.

Reprogramming the Secondary Priority (PLUS) Channel

1. Press and hold the **16/PLUS** key for 3 seconds to switch to the current Secondary Priority (PLUS) Channel.
2. Press and hold the **16/PLUS** key for 3 seconds again to switch to Reprogram mode. The message CHG 2ND PRI? appears with YES highlighted.
3. Press SELECT soft key to accept. The confirmation message CHANGE 2ND PRIORITY CH appears.
4. Rotate the **CH/OK** knob until the desired new secondary channel is shown.
5. Press the OK soft key to accept the new Secondary Priority (PLUS) selection.

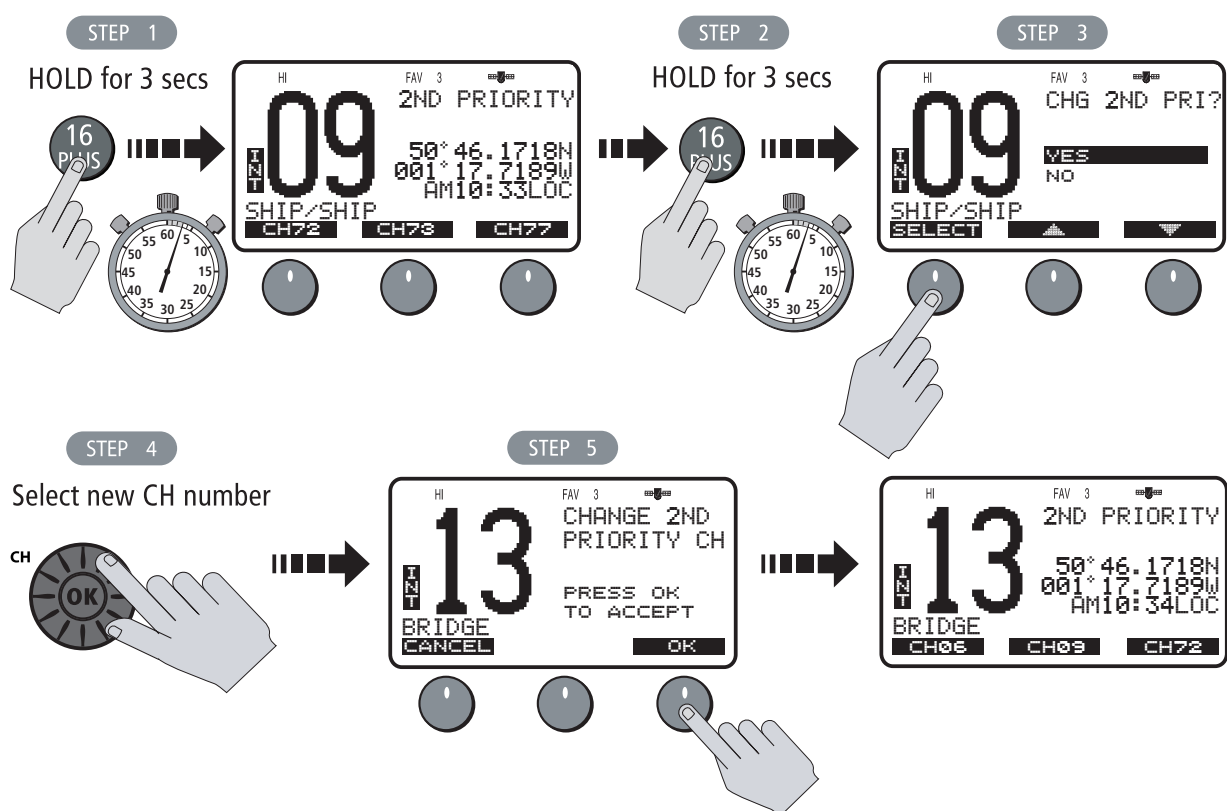

3.11 Transmitting



Press and hold the Push-to-Talk (**PTT**) key on the microphone to transmit on the selected channel, and then release to receive. The TX indicator appears during transmission.

Note: *International regulations and good communications practice dictate that you not interfere with other communications. Before transmitting, listen to make sure the channel is clear.*

The radio is equipped with a timeout timer in the event of a stuck key. After **PTT** has been held continuously for 5 minutes, transmission is discontinued, the message TX TIMEOUT appears, and the radio automatically returns to receive mode.

After the timeout, the alarm continues to sound until **PTT** is released. The TX time out timer is reset once the **PTT** key is released.

Note: *If the current channel is receive-only, an alert tone sounds when PTT is pressed, indicating such a transmission is not permitted.*

3.12 Menu Mode Operation



Press and release the **MENU/DSC** key while in standby mode to enter Menu Mode.

Menu mode is fully described in Chapter 4.

3.13 DSC Call Operation



Press and hold the **MENU/DSC** key for greater than 3 seconds while in standby operation mode to enter DSC Call Mode.

DSC Call mode is fully described in Chapter 5.

Chapter 4: Menu Settings

4.1 Menu Function



Most of the radio's functions reside in the Main Menu, which is accessed through the **MENU/DSC** key. A diagram of the menu structure can be found in Appendix C.

Making Menu and Programming Selections

There are three ways to make menu and character selections in your radio:

1. Most examples in this chapter describe making selections using the **CH/OK** knob and soft keys on the transceiver.
2. However, you can also press the microphone up/down keys to make your selections and then press the microphone **HI/LO** key to accept.

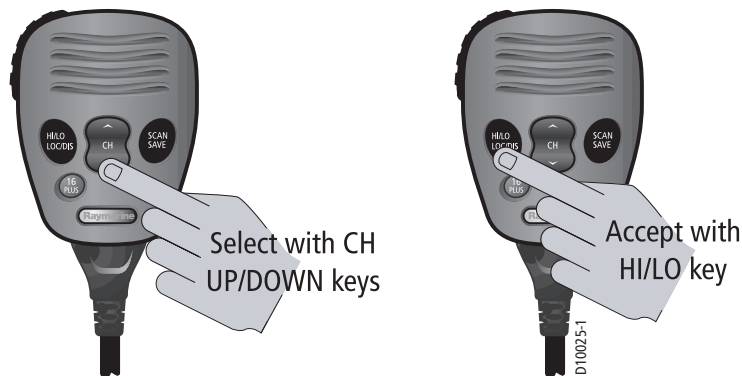

3. Alternatively, if you have an optional Raymic, you can use its **CH** up/down keys to select and **OK** key to accept.

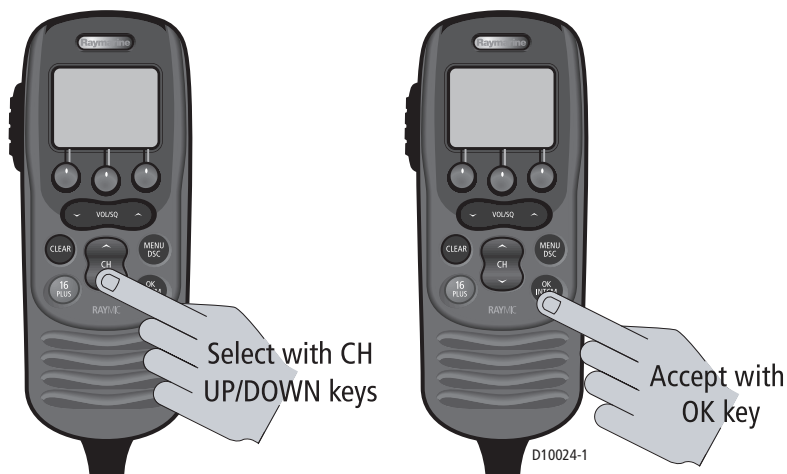

To make Menu selections:

1. Press and release the **MENU/DSC** key to enter Menu mode. The list of available menu groups appears.

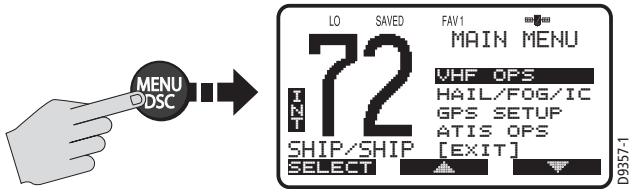

2. Use the up/down arrow soft keys, **CH/OK** knob on the transceiver, or **CH** up/down key on the microphone (or Raymic) to scroll through the list until the desired menu is highlighted.

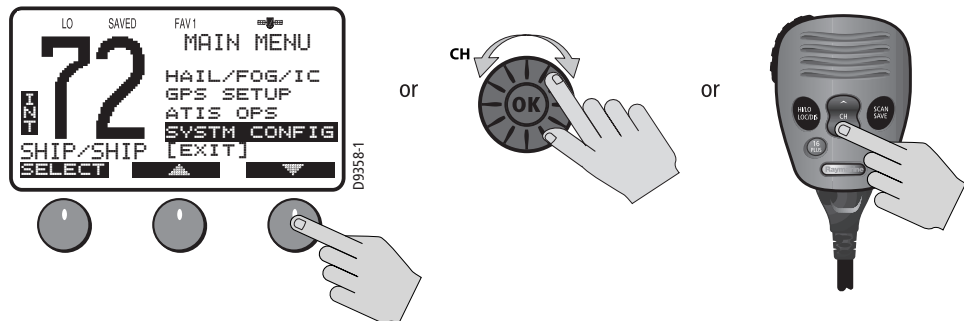

3. Press **SELECT**, the **CH/OK** knob on the transceiver, **HILO** key on the microphone, or **OK** key on Raymic to accept. The sub-menu headings are displayed.

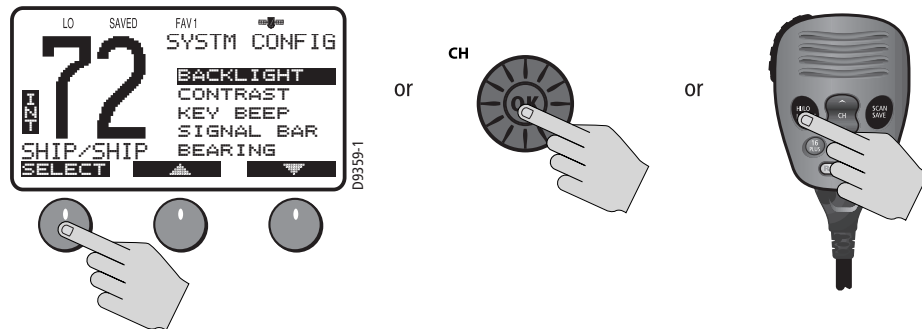

4. Use the up/down arrow soft keys, **CH/OK** knob on the transceiver, or the **CH** up/down key on the microphone (or Raymic) to point to the desired sub-menu.

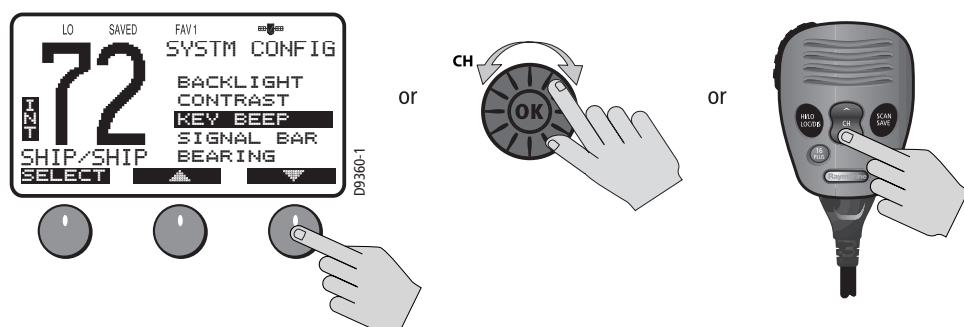

5. Press SELECT, the **CH/OK** knob on the transceiver, **HI/LO** key on the microphone, or **OK** key on the Raymic to accept. The options under that sub-menu are displayed.

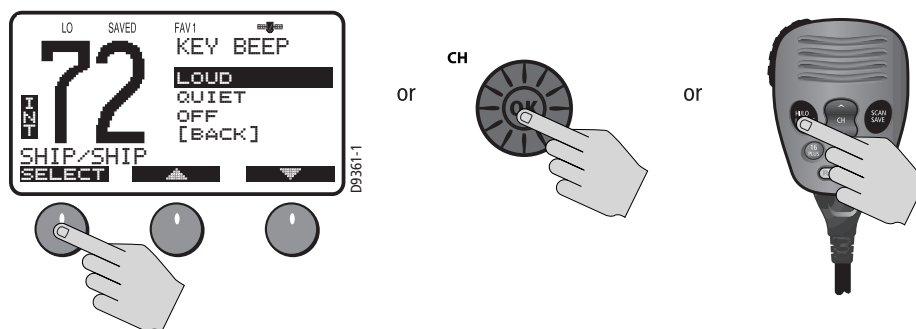

6. Use the up/down arrow soft keys, the **CH/OK** knob on the transceiver, or **CH** up/down key on the microphone (or Raymic) to highlight the desired option.

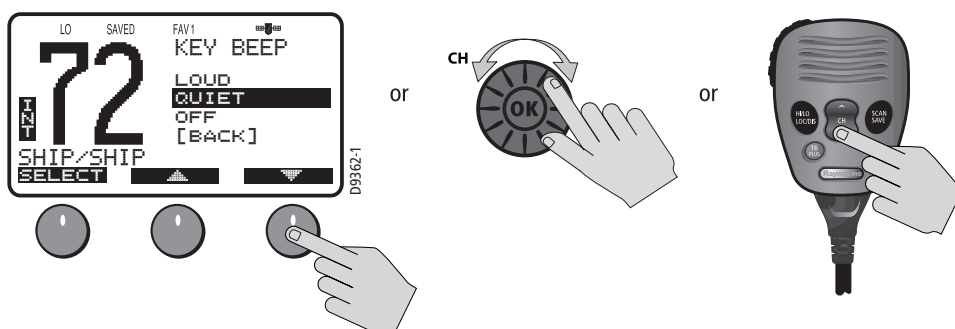

7. Press SELECT, the **CH/OK** knob on the transceiver, **HI/LO** key on the microphone, or **OK** key on Raymic to accept. The setting is changed. Continue in the same manner to make any other setting changes.

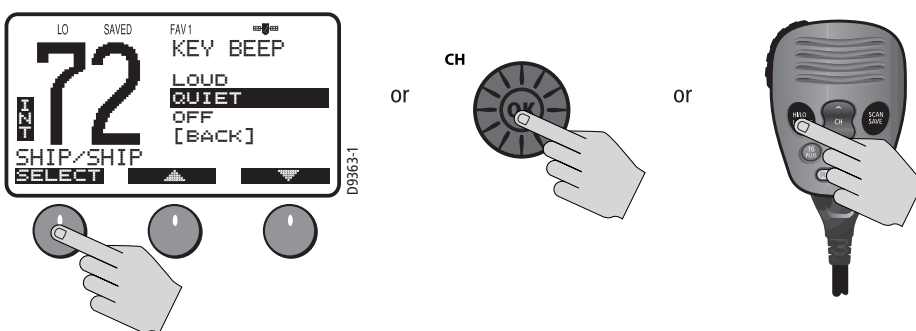

To return to the previous menu level, select the [BACK] menu option or press the **CLEAR** key.

To exit the Menu mode, press the **CLEAR** key again or else press the **16/PLUS** key to switch to the priority channel in standby mode.

4.2 VHF Operations

This menu group controls basic radio functions. You access VHF Operations via the **MENU** key.

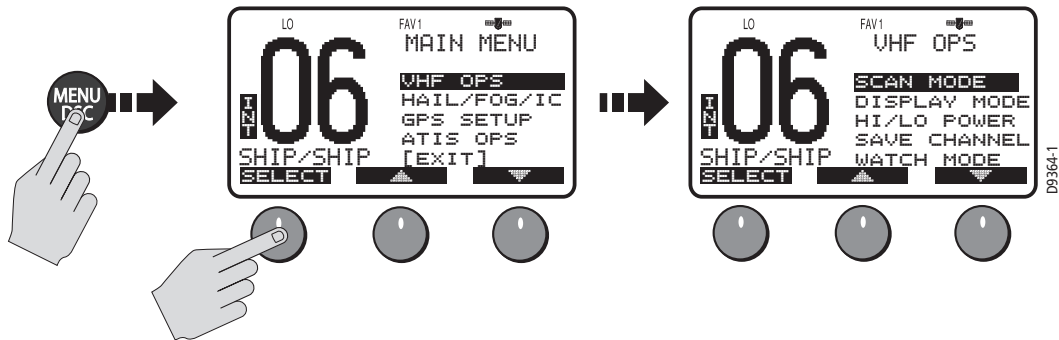

Scan Mode

This function automatically searches through all channels in the set for any that are broadcasting. If a transmission is received, the scan stops on the receiving channel as long as it is present. If the signal is lost for five seconds, the radio resumes scanning.

If you wish to temporarily remove a received channel from the scan so that the scan no longer stops on this channel, press the XCLUDE soft key. The selected channel is only excluded for the time you are currently in scan mode.



You can directly access the Scan Mode menu by pressing and releasing the **SCAN/SAVE** key on the microphone. When a Scan Mode is active, you can terminate the scan and return the radio to standby mode by pressing and releasing the key again.

While scanning, press the microphone or Raymic **CH** up/down keys or else rotate the **CH** knob on the transceiver to change the scan direction. UP (key)/clockwise (**CH** knob) increases the channel while DOWN (key) /counter-clockwise (**CH** knob) decreases it.

Your Ray218E/Ray55E is equipped with four types of scan options: All Scan, Saved (Memory) Scan, Priority All Scan and Priority Saved Scan. The following illustration demonstrates how to initiate All Scan but the procedure is the same for all scan mode options.

Note: *Whenever Weather Alert is activated, the WX Alert channel is also monitored during the Scan Modes. If the WX Alert tone is detected, the scan is halted to receive the Weather Alert broadcast.*

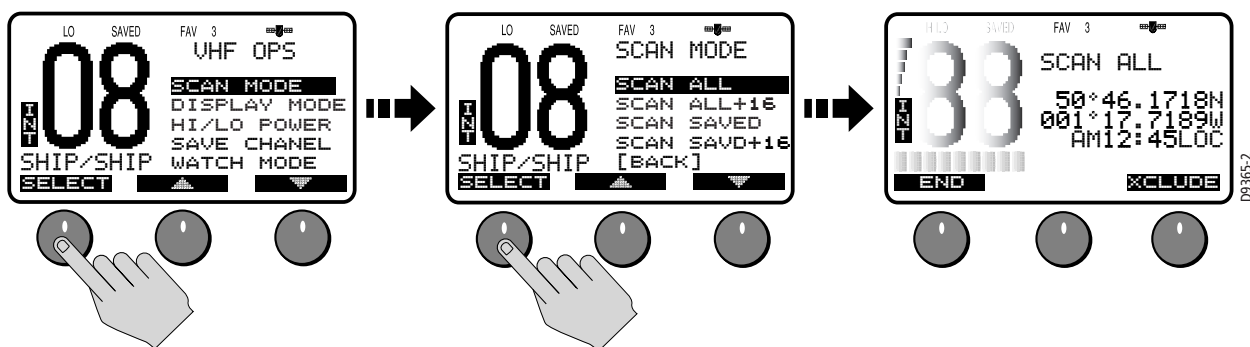

To *terminate* the SCAN mode and return to standby mode, press:

- END soft key
- **SCAN/SAVE** key on the microphone
- **CLEAR** key on the transceiver
- **CLEAR** key on the optional Raymic

All Scan

In All Scan mode, all channels in the channel set are scanned in sequence. After the last channel number has been scanned, the cycle repeats.

When active, SCAN ALL appears on the display.

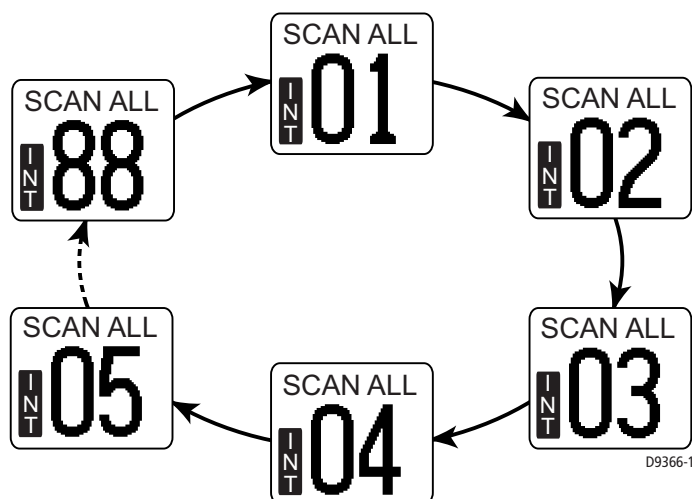

Priority All Scan

Priority All Scan searches for activity on all channels but alternates scanning the Priority Channel 16 after each channel.

When active, SCAN ALL + 16 appears on the display.

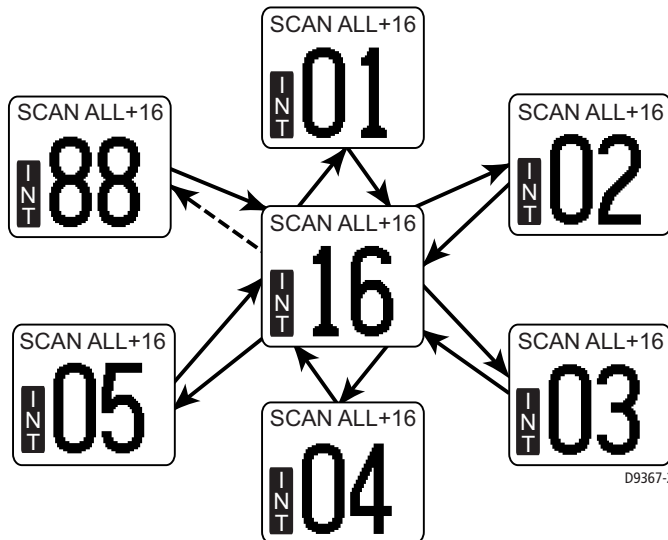

Saved (Memory) Scan

In Saved Scan mode, only the channels that have been saved in memory are scanned in sequence. After the last saved channel number has been scanned, the cycle repeats.

When active, SCAN SAVED appears on the display. If no channels have been saved into memory when you select this feature, an error tone sounds.

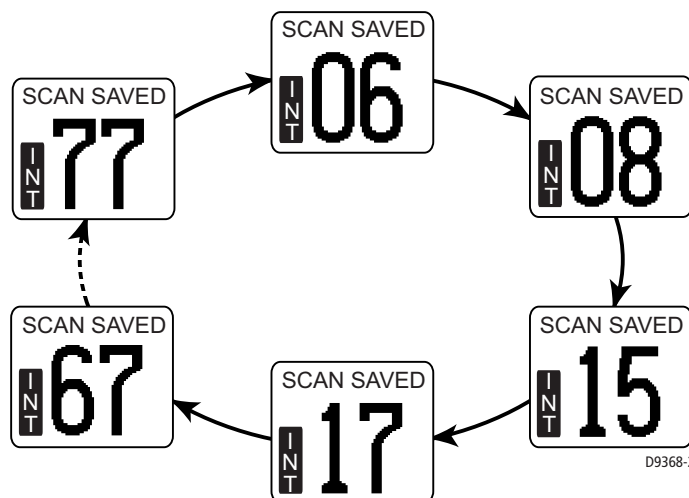

Priority Saved Scan

Priority Saved Scan is much like Priority Scan except that the radio alternates searching for activity on the Priority Channel 16 and the channels stored in memory.

When active, SCAN SAVD + 16 appears on the display.

Note: *If no channels have been saved into memory when you select this feature, an error tone sounds.*

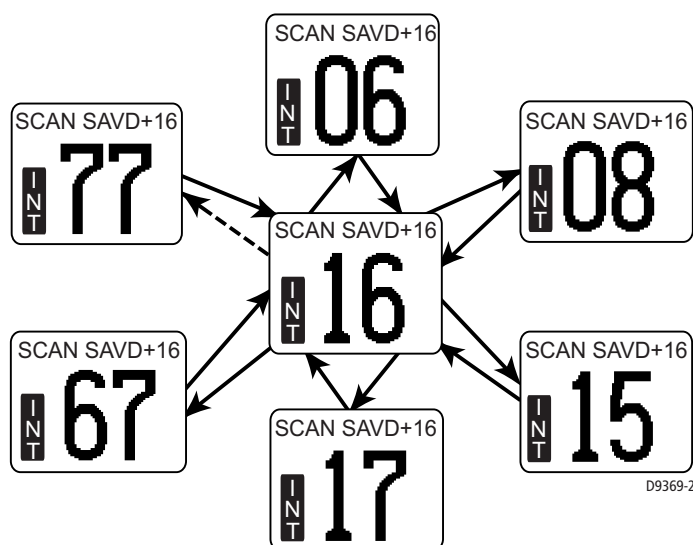

Display Mode

The Ray218E/Ray55E has two methods for displaying the channel number: 1 UP and 2 UP. 1 UP mode is the normal mode; the channel is displayed on the left side of the display and text information on the right.

In 2 UP mode, you are presented with two channels: the currently-active channel on the left and the standby channel on the right. Pressing the double arrow soft key determines which of the two displayed channels is the active one. While in 2 UP mode, pressing the channel up/down keys CHANGES THE STANDBY CHANNEL, NOT THE ACTIVE ONE.

The radio exits 2 UP mode when you enter the menu or DSC call screens.

1 UP

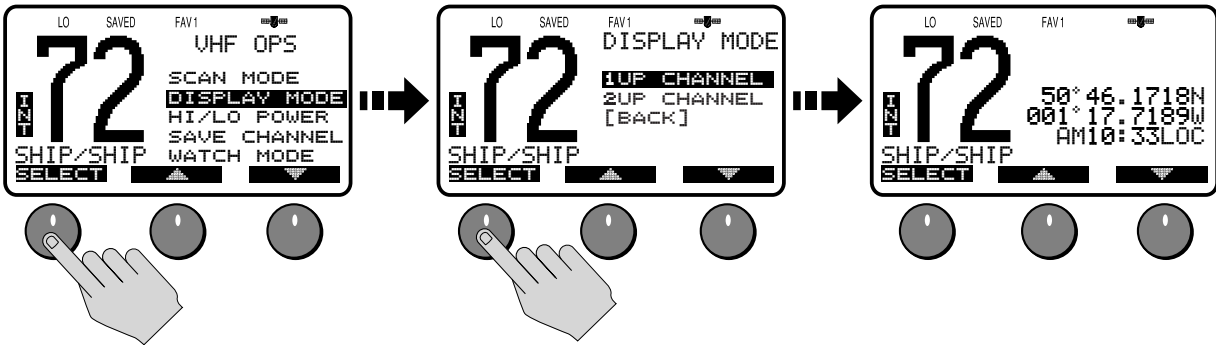

2 UP

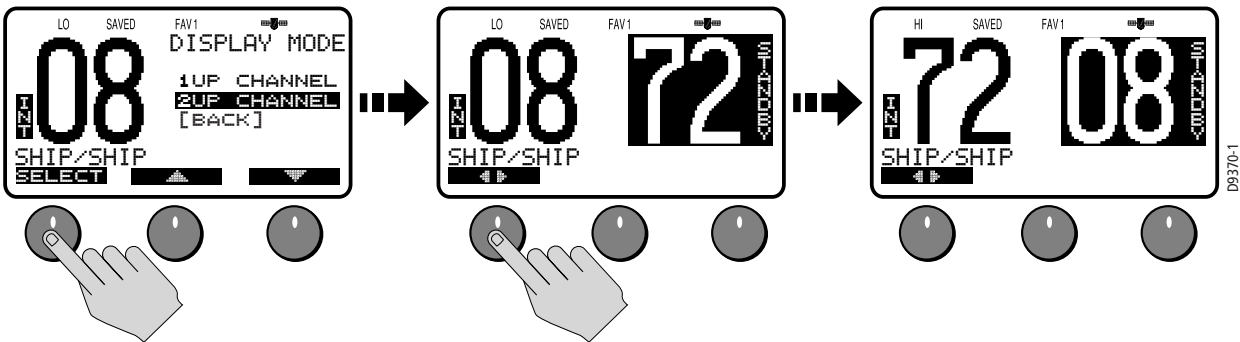

Setting the Power Output (HI/LO)

The choice of power output is dependent upon the distance of transmission and transmitting conditions. As a part of marine communications courtesy, make initial contact using low power. Switch to high power only when contact can not be made on low power or in emergency situations. International regulations state that you must use the minimum power possible for satisfactory communication.

If conditions require that you change transmission power for the currently-selected channel, select the HI/LO POWER menu option under VHF OPS. Press the HI/LO soft key to toggle the TX power from LOW (1 watt) to HIGH (25 watts). The corresponding LO or HI indicator appears.

You can also press the **HI/LO-LOC/DIS** key on the microphone to toggle TX power.

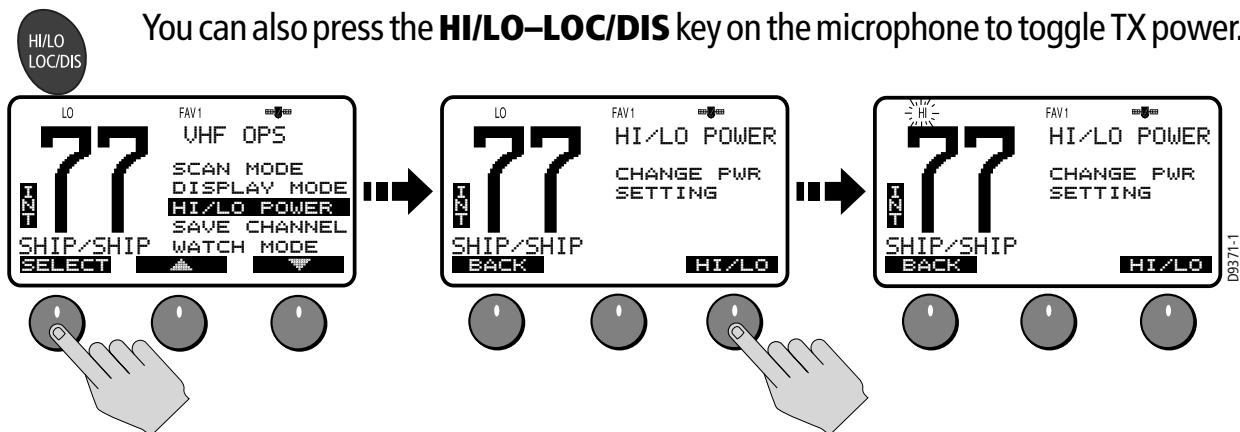

Some channels are limited by regulation to be low power only. If the HILO operation request is denied, an error tone beeps.

Channels restricted to low transmit power are as follows:

- Canadian channel set: 13, 15, 17, 77
- International channel set: 15, 17, 75, 76
- US channel set: 13, 17, 67, 77

Saving Channels to Memory

The Ray218E/Ray55E can store any channel (including Private Channels) into memory. The stored channels are the ones scanned in the Saved (Memory) Scan mode (see page 46). Any number of channels can be saved as memory channels.

Separate memory channel groups exist for USA, International, and Canadian frequency sets.

To add or remove a channel to/from memory:

1. Select SAVE CHANNEL from the VHF OPS menu.
2. Rotate the **CH/OK** knob to select the channel to be added/removed from memory.
3. To add the selected channel from memory, press SAVE. The **SAVED** icon appears to indicate the current channel has been saved in memory.

To remove the channel from memory, press CLEAR. The **SAVED** icon disappears.

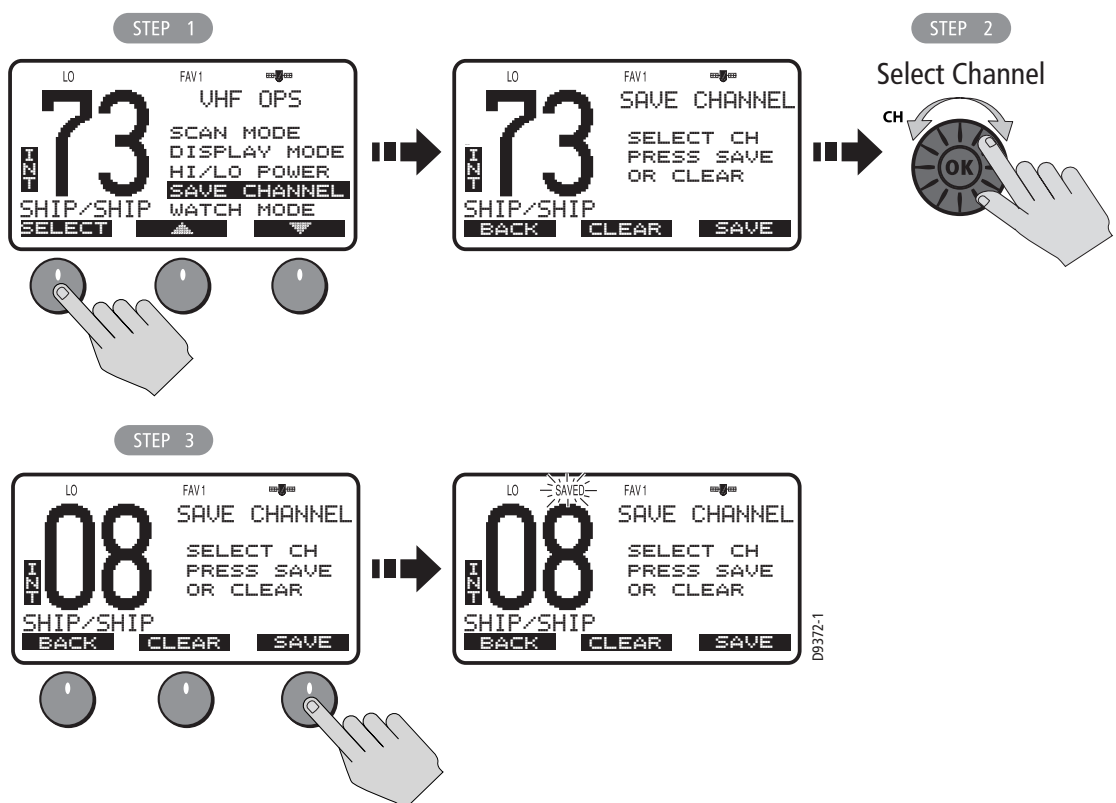



You can also add the current channel to memory by pressing and holding the **SCAN/SAVE** key on the microphone. If the channel is already saved, pressing and holding the key removes the channel from memory.

Using the Watch Modes

The Watch Modes monitor the programmed Priority Channel and other user-selected channel(s). The watch is halted when activity is detected on a monitored channel. The Ray218E/Ray55E is equipped with 2 types of monitor operations: Dual Watch and Tri Watch.

Note: *Monitor modes are disabled when the ATIS operation is active.*

Dual Watch

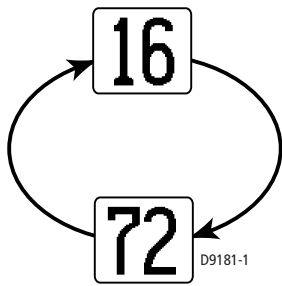

Dual Watch monitors the current working channel and Channel 16 in cycle.

DUAL 16 appears on the top line of the display.

Dual Watch is demonstrated in the figure to the left; the sample working channel is channel 72.

Tri Watch

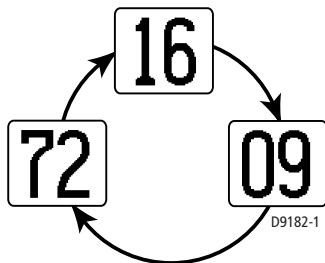

Tri Watch monitors in cycle channel 16, the current working channel and the channel you have set as the Secondary Priority (PLUS) Channel.

TRI 16+09 appears on the top line of the display.

Tri Watch is demonstrated in the figure to the left; the sample working channel is channel 72.

Press the **END** soft key to terminate Watch mode and return to the previous working channel.

Press and release the **16/PLUS** key to terminate Watch mode and switch to the Priority Channel.

Press and release the **CLEAR** key to terminate Watch mode and return to the last-used channel.

Note: *During Tri Watch Mode, the CH key is inactive and an error beep sounds if pressed.*

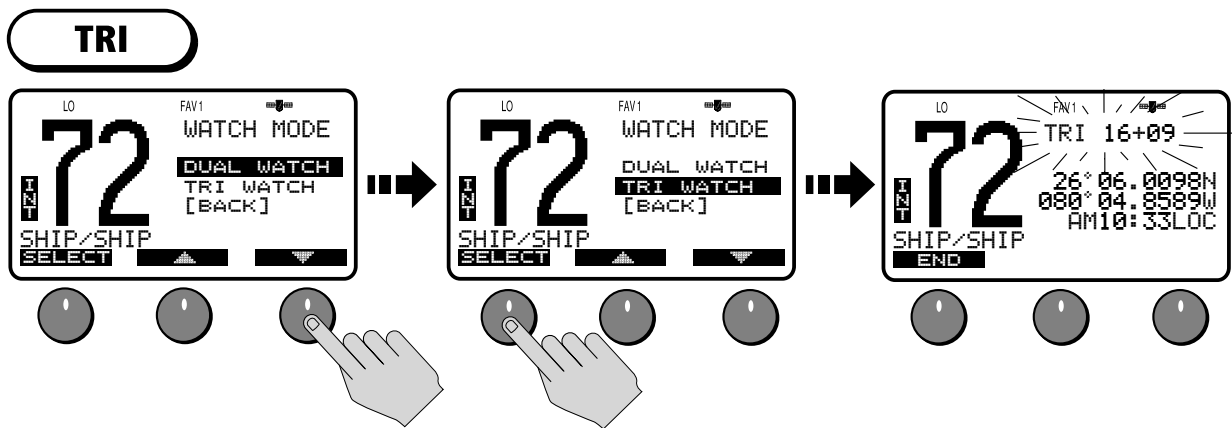
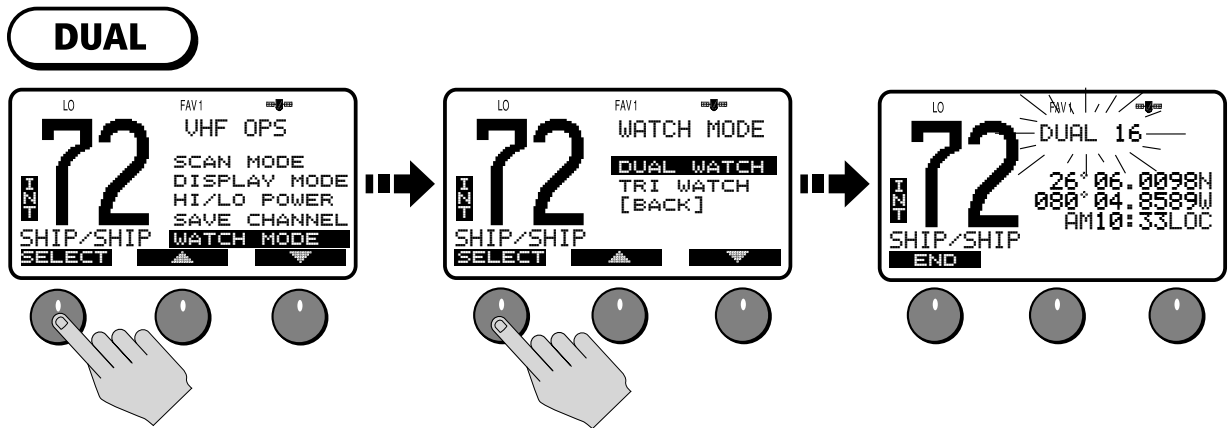

Frequency Band

The Ray218E/Ray55E can transmit and receive all USA, International and Canadian frequencies, if available. This setting determines which channel set is being used. The appropriate indicator is illuminated in the LCD: USA, INT for International, or CAN for Canadian channel sets.

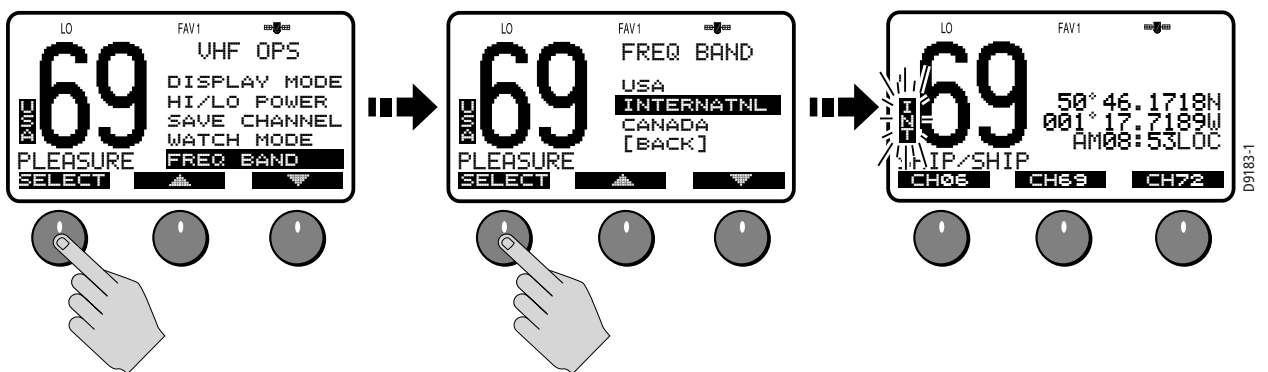

Channel Name

By default, the Ray218E/Ray55E scrolls a descriptive name of up to 16 characters in the line directly below the channel number and then stops to display a fixed length of up to 9 characters. This option modifies the name for the currently-selected channel from its default.

To change the Channel Name from the default:

1. From the VHF OPS menu, select CHANNEL NAME.
2. Press EDIT. The name for the currently-selected channel appears.
3. Use the **CH/OK** knob to modify the NAME field using the same technique described in "Adding a new Entry" on page 79.
4. Press DONE when completed.

To completely remove the Channel Name, press CLEAR in step 2 above. If the name is deleted, the space below the channel number is blank for that channel.

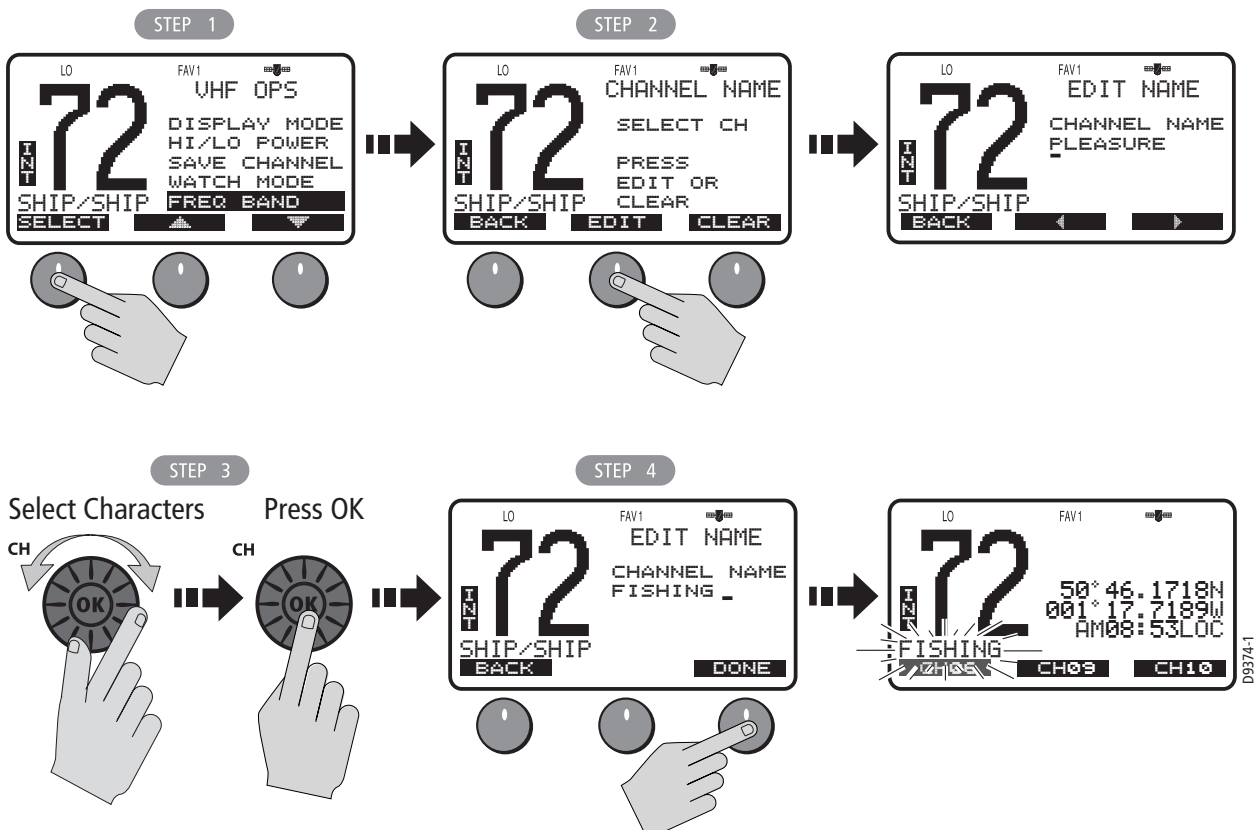

Favorite Channel

When in standby mode, the Ray218E/Ray55E displays a channel number in each of the three soft key locations. By pressing the corresponding soft key, the radio instantly switches to that channel number. You can select from three separate Favorite Channel groups for a total of 9 channel options for each frequency set. You select which channel group is displayed and edit what channel numbers are assigned.

Default channels are as follows:

- FAV1: CH67 CH68 CH72
- FAV2: CH71 CH73 CH77
- FAV3: CH06 CH08 CH09

To SELECT which bank of Favorite Channels is displayed:

1. From the VHF OPS menu, select FAVORITE CH.
2. Highlight the Favorite Channel Bank you wish to be displayed.
3. Press the SELECT soft key. Two options appear: SELECT and EDIT.
4. Choose the SELECT option.
5. Press OK to confirm. Selected favorite channels appear in the soft key bank.

SELECT

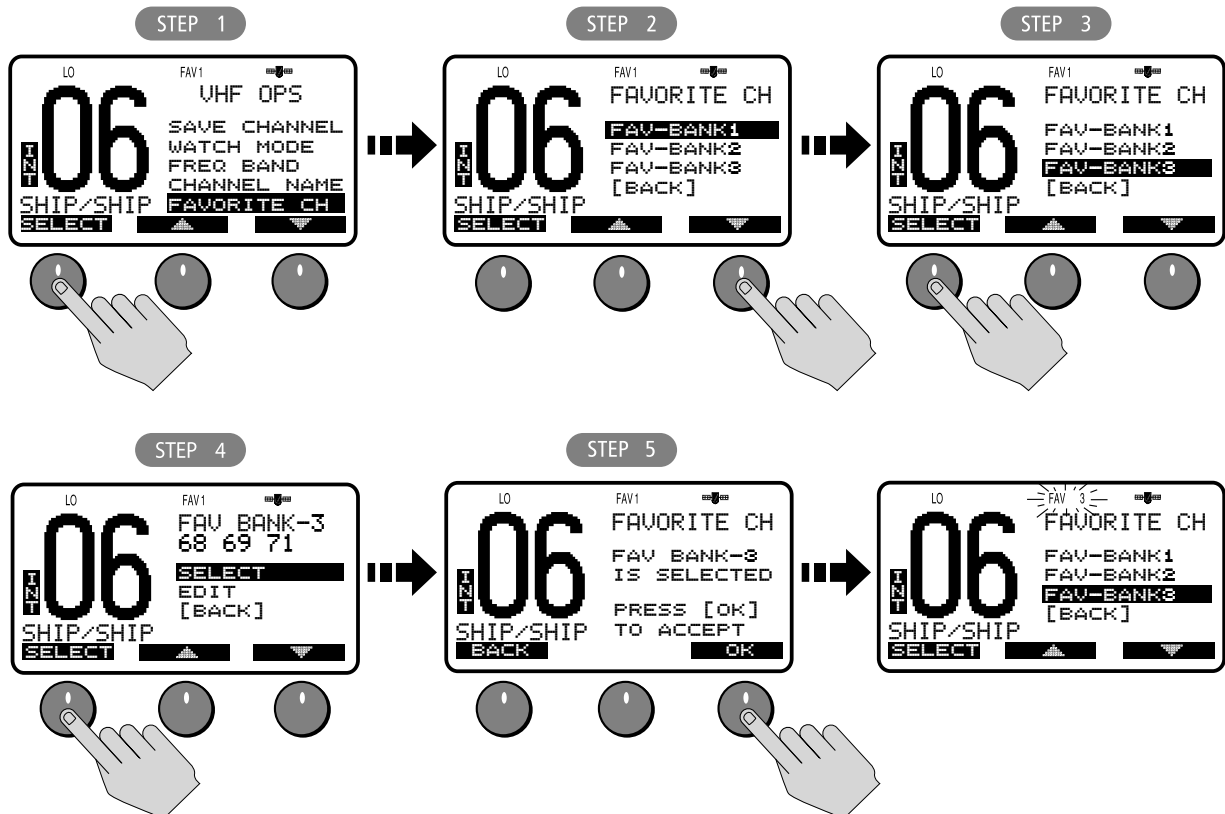

To EDIT Favorite Channels contained within a bank:

1. Repeat steps 1–3 above for the SELECT process and highlight the bank you wish to edit.
2. Select the EDIT option.
3. Use the up/down arrows to highlight which soft key label you wish to edit: LEFT, CENTER or RIGHT.
4. Rotate the **CH/OK** knob to change the channel to the desired value.
5. Push in the **CH/OK** knob to confirm. The new channel selection appears in the edited soft key position for that bank.

EDIT

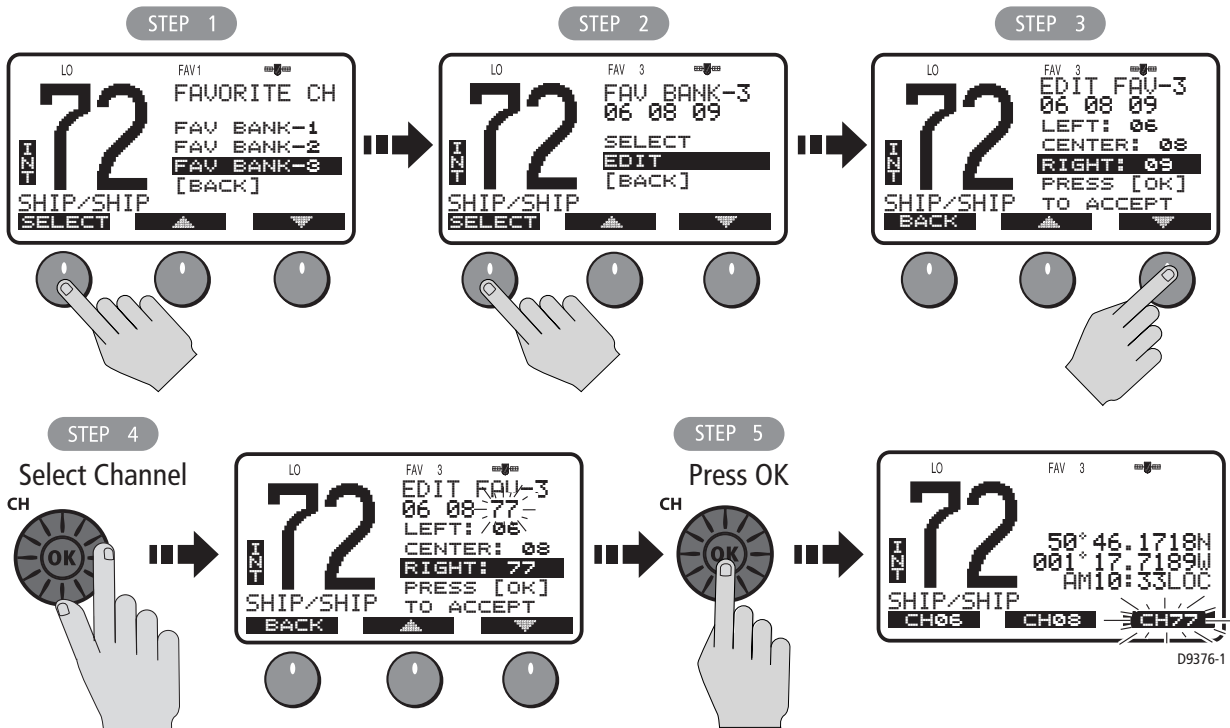

Shortcut

You can quickly access the Favorite Channel menu item by pressing and holding any of the three channel soft keys in standby mode.

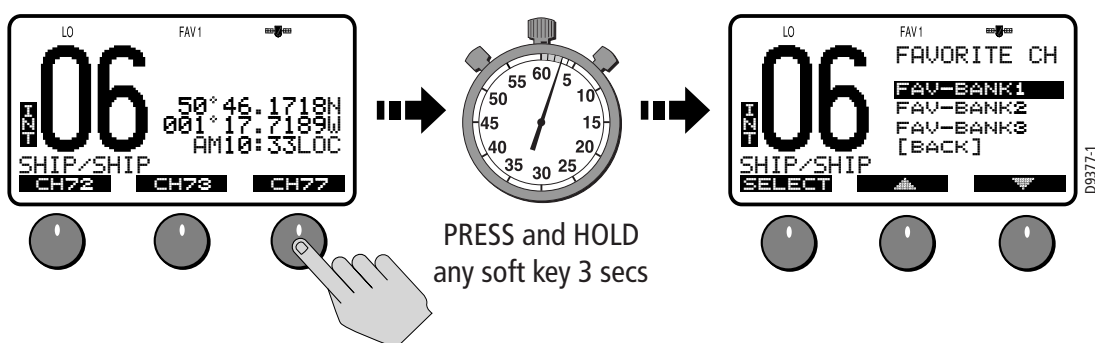

Sensitivity

Use this setting to switch the transmit power from high to low. Press the L/D soft key to toggle between full receiver sensitivity (Distant mode) and attenuated receiver sensitivity (Local mode). The LOCAL icon appears while in Local mode and then is removed in Distant mode.

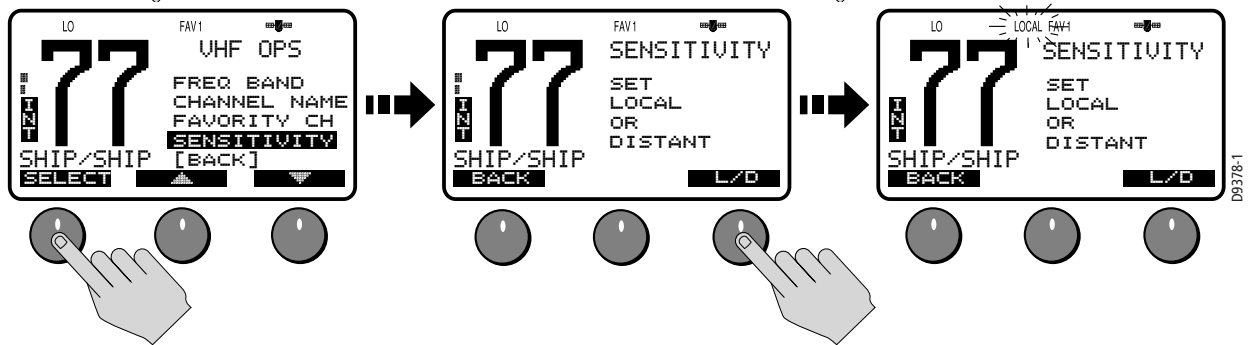

4.3 Hailer/Fog Horn/Intercom

Hailer and Fog operations are available on the Ray218E, but not on the Ray55E. You must purchase and install an optional hailer horn for these features to operate. Intercom operations are available on both the Ray218E and Ray55E.

Note: *This menu item provides access to auxiliary functions. While these operations are active, you cannot send or receive radio calls. The exception is in AUTO FOG mode, between soundings.*

Hailer (Ray218E only)

The Hailer operation enables the unit to use a Hailer Horn as a loudspeaker. Press and hold **PTT** to place the unit in Hailer mode. Anything spoken into the handset is amplified and broadcast from the Hailer Horn (but not transmitted over the radio). To adjust the Hailer Horn broadcast volume, use the up/down arrow soft keys while pressing and holding **PTT**.

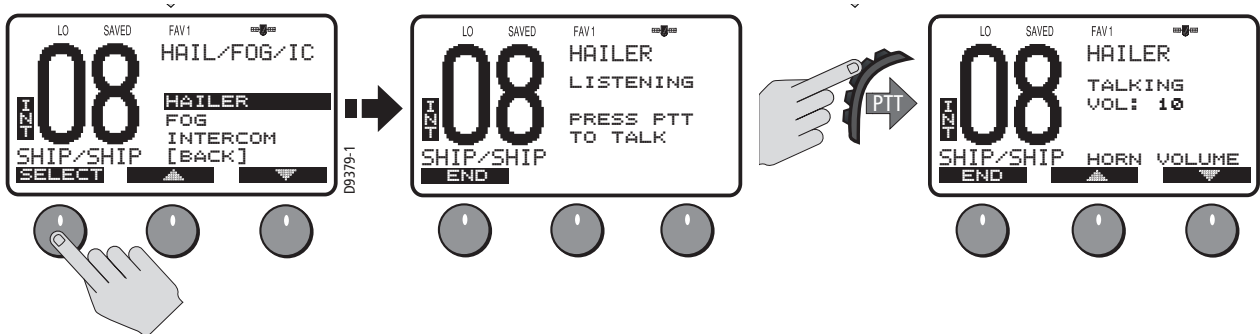

Release **PTT** to switch to Listen mode. The Hailer Horn then acts as a directional microphone. Sounds picked up by the Hailer Horn are heard on the radio speaker. To adjust the Hailer Horn broadcast volume, use the up/down arrow soft keys.

Fog Horn (Ray218E only)

This operation enables the radio to emit various fog horn tones over a hailer horn speaker. Select one of the following modes, and then press SELECT to enable the selection:

MANUAL FOG

Pressing the **PTT** switch sounds a continuous 400 Hz tone for as long as you hold the **PTT**.

AUTO FOG

Sounds a predetermined pattern. Press END soft key or any hard key (**CLEAR**, **HAILER/INTCM**, etc.) to quit.

Note: *Between AUTO Fog Horn soundings, you can make and receive calls.*

Select one of the following modes, and then press SELECT to enable the selection:

- PWR MAKE WY—Power vessel underway
- NOT MAKE WY—Power vessel not underway
- SAIL/FISHNG—Sailing vessel or any vessel fishing but not trolling
- RSTRICT/TOW—Restricted in ability to maneuver or towing another vessel
- UNDER TOW—This vessel being towed
- PILOT—This vessel is a pilot vessel
- AT ANCHOR—Vessel is at anchor
- AGROUND—Vessel is aground

Volume is controlled by the up/down soft keys.

Intercom

When a Raymic secondary handset is installed, Intercom operation enables voice communications between the Raymic and the transceiver. You can initiate the call from either the transceiver or second station. The following illustrates what is displayed when the Ray218E transceiver initiates the call.

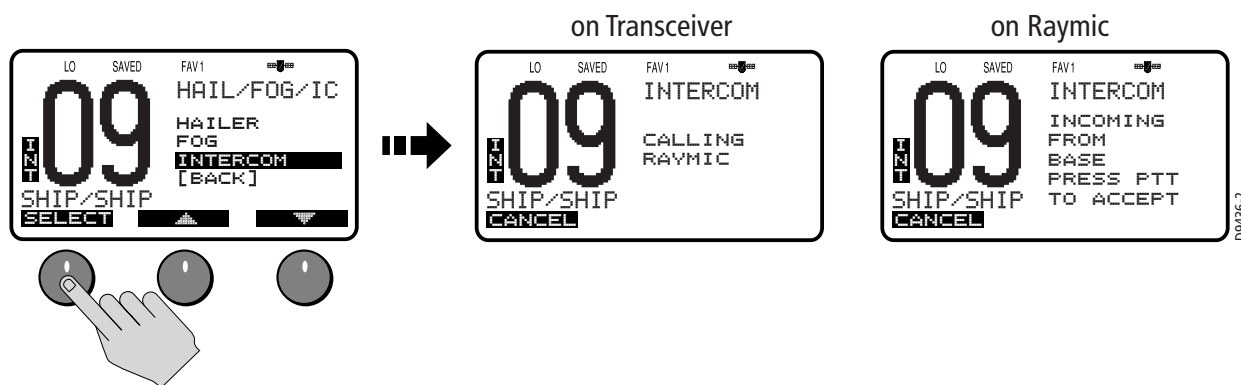

To initiate an Intercom call:

1. Select INTERCOM from the sending station (transceiver or Raymic):

Ray55E: Select INTERCOM directly from the main menu.

—or—

Ray218E: Select INTERCOM from the IC/HAIL/FOG menu.

—or—



Ray218E: Press and hold the **HAILER / INTCM** key.

—or—



Raymic: Press and hold the **OK / INTCM** key.

The receiving station sounds an alert tone and displays a message that an intercom call is incoming.

2. On the receiving station, press **PTT** to accept the call and respond. While **PTT** is depressed, that station displays TALKING and the other station displays LISTENING. When neither station is pressing **PTT**, both LCD's display PRESS PTT TO TALK.
3. On the sending station, when the LCD no longer reads TALKING, press **PTT** to talk.
4. To terminate the call, press END from either station.

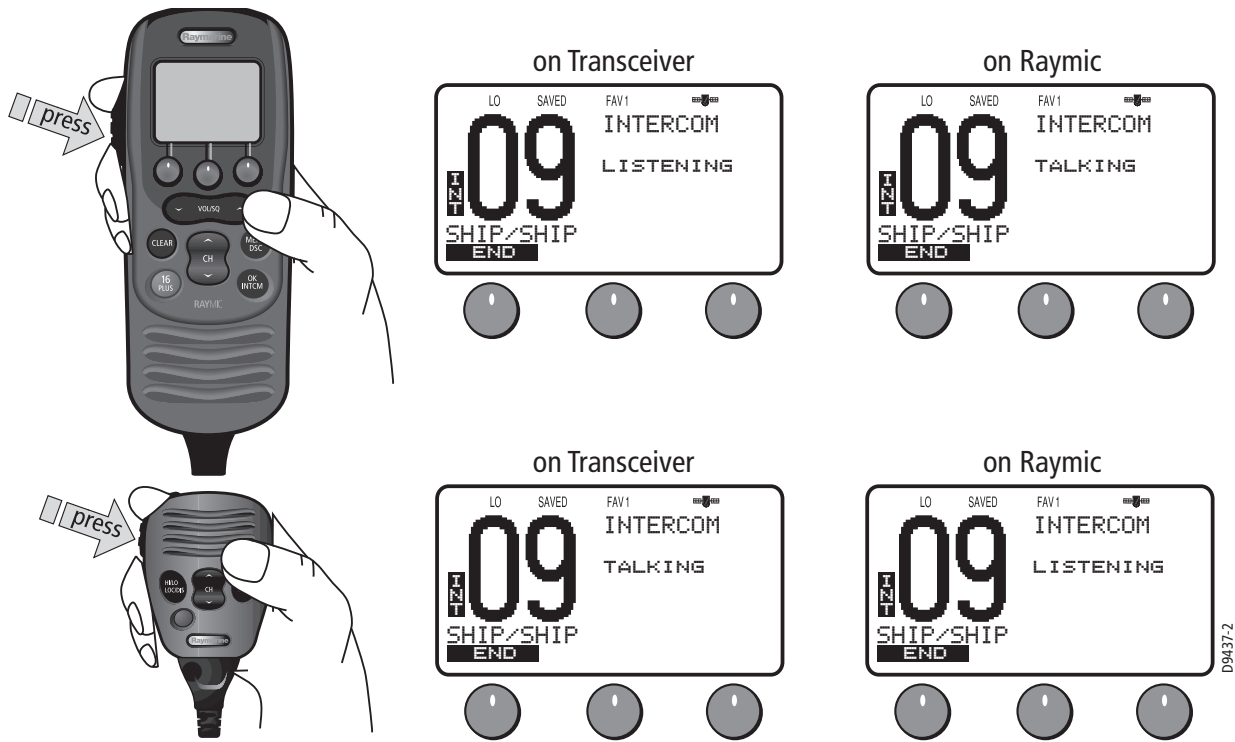

4.4 GPS/Time Setup



By default, the Ray218E/Ray55E auto-detects NMEA 0183 strings and decodes appropriate latitude/longitude position and time or COG/SOG. When position data is available, the GPS satellite icon appears on the top line of the LCD. If the GPS navigation receiver is not connected or is not functional, a manual latitude/longitude position and UTC time can be entered and used in the DSC distress transmitted message.

Manual Position

If no GPS data is available and the MMSI number has been programmed, the GPS icon blinks and POS DATA REQ is displayed on the dot matrix display, followed by NO POS DATA. An alarm sounds for 5 seconds or until you acknowledge by pressing any key.

The alert repeats every four hours as long as no position information has been entered manually. If position data is entered manually but has not been updated during the previous 23.5 hours, all the position (lat/lon) fields are set to all 9's, time field is set to all 8's, and the display reverts to NO POS DATA.

Note: *The Manual Lat/Lon function is valid only when your radio is not connected to a GPS receiver.*

To manually set the GPS position and time settings:

- Under the GPS SETUP menu, select MANUAL POS. The Manual Position screen appears.
- Using the **CH/OK** knob, fill in the Lat/Lon and time information, one character at a time. The first character space is highlighted with a flashing underline. A more-detailed description of manual character entry can be found in "Adding a new Entry" on page 79.
 - Rotate the **CH/OK** knob to scroll through the selections.
 - When the desired character appears, push in the **CH/OK** knob to accept it. The next character to be filled in sequence is underlined (_).
 - Use the < and > soft keys to edit selected characters, if necessary.
 - Continue this process until all latitude data been selected.
 - When the direction character is underlined, rotate the **CH/OK** knob to toggle between N and S, if necessary.
 - Press the **CH/OK** knob when the desired direction character is displayed. The first character in the longitude field is now underlined.
 - Use the same process to complete longitude information.
 - Use the same process to complete time information. When time data is entered manually, the MAN indicator appears in front of the time, which is displayed in UTC.
- Press DONE soft key when complete. The radio returns to the GPS Setup menu.
- Select BACK to exit the menu.

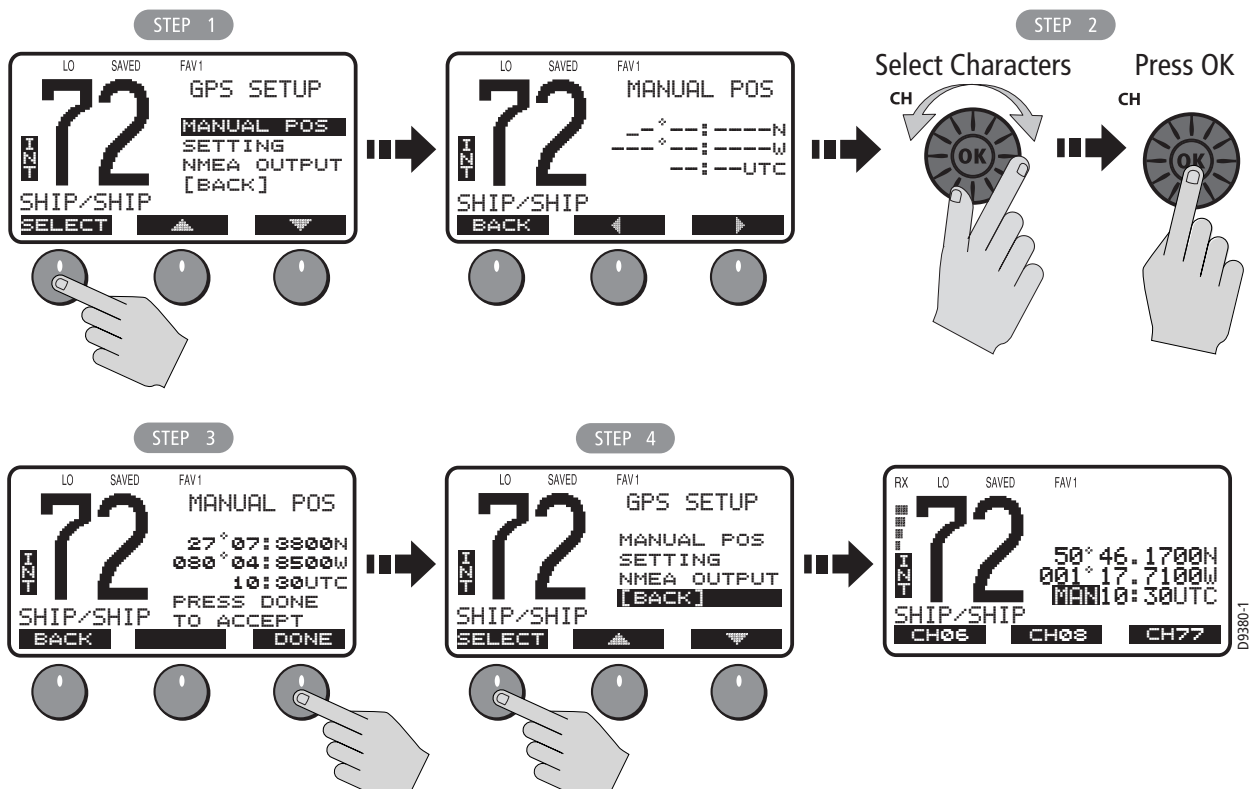

Settings

You can also set how some time and position information is displayed on the screen. Make your selection from the options on the list.

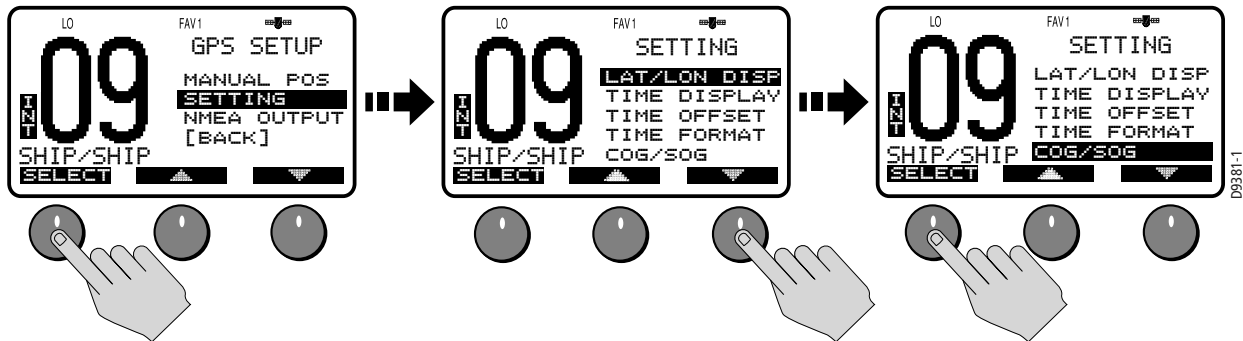

Latitude/Longitude Display

The LAT/LON DISP setting indicates whether Latitude and Longitude position data are displayed on the screen in standby mode.

Time Display

The TIME DISPLAY setting indicates whether time information is displayed on the screen in standby mode. When manual time is used, it is always displayed as UTC time, even if you have entered an offset.

Note: If TIME DISPLAY is set ON, COG/SOG is automatically set to OFF. Because they occupy the same line on the LCD, only one of these two settings can be displayed at a time.

Time Offset

The TIME OFFSET setting indicates the amount of time to add or subtract from UTC time to equal your local time. Rotate the **CH/OK** knob to select a value from between +13 to –13 hours of UTC and then press ACCEPT to confirm. After setting up Time Offset, “LOC” is displayed to the right of the Time field to indicate local time.

Note: The Time Offset setting is valid only when GPS data is available. When manual time is used, it is always displayed as UTC time, even though you have entered an offset.

Time Format

The TIME FORMAT setting indicates whether the time is displayed in 12 hour or 24 hour format.

COG/SOG Display

This setting determines whether Course Over Ground and Speed Over Ground (COG/SOG) data from the GPS is displayed on the bottom line of the dot matrix display instead of the time of day. The menu setting "Bearing Mode" on page 67 determines whether the True or Magnetic heading is displayed for COG. The setting "Speed Unit" on page 68 determines whether knots, MPH or KPH is used for SOG.

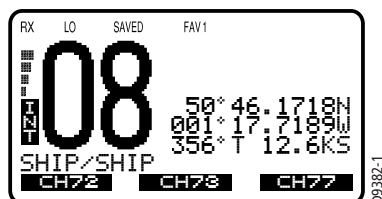

Note: If COG/SOG is set ON, TIME DISPLAY is automatically set to OFF. Because they occupy the same line on the LCD, only one of these two settings can be displayed at a time.

NMEA Output

When Distress Call and Position (lat/lon) information is received from other stations, your Ray218E/Ray55E has the capability of forwarding this data to your display unit (C Series, E Series, etc.) over the NMEA port so that it can be displayed on the screen. You can specify which stations will have their position data and Distress Call information sent to the display unit.

SEL OUTPUT

Use this option to select the stations for which you want incoming position data and Distress Call information to be displayed.

1. From the GPS SETUP menu, select NMEA OUTPUT.
2. From the NMEA OUTPUT menu, select SEL OUTPUT.
3. Select which vessel's position data will be forwarded to the display:
 - ALL STATION. Forward all received position data to the display.
 - LIST STATION. Send position data from stations that you have selected from a list. If you choose this option, specify the permitted vessels using the SEL STATION option described below.
 - NONE. Do not forward position data from any station.

SEL STATION

If you enabled LIST STATION in the SEL OUTPUT menu, this option presents a list from which you can select the stations whose data will be forwarded.

1. As outlined above in step 3, ensure you have selected LIST STATION from the SEL OUTPUT menu.
2. From the NMEA OUTPUT menu, select SEL STATION. The list of stations in your Phone book is displayed.
3. Using the up/down arrow soft keys, highlight the first station whose data you want to have forwarded to the display unit.
4. Press SELECT. An arrow appears to the left of the station name, indicating that it has been selected.
5. Continue until all stations for which you want to allow data to be forwarded have been selected (have an arrow next to the station name).
6. Select [BACK] to exit.

SEL OUTPUT

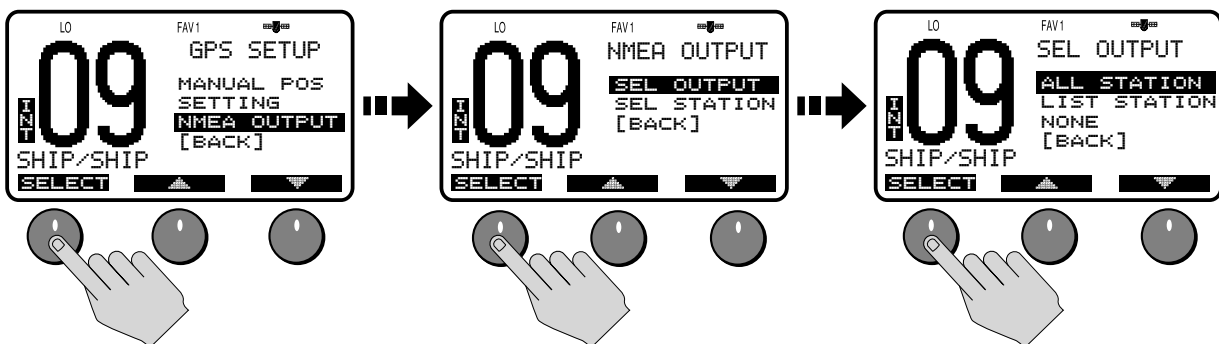

SEL STATION

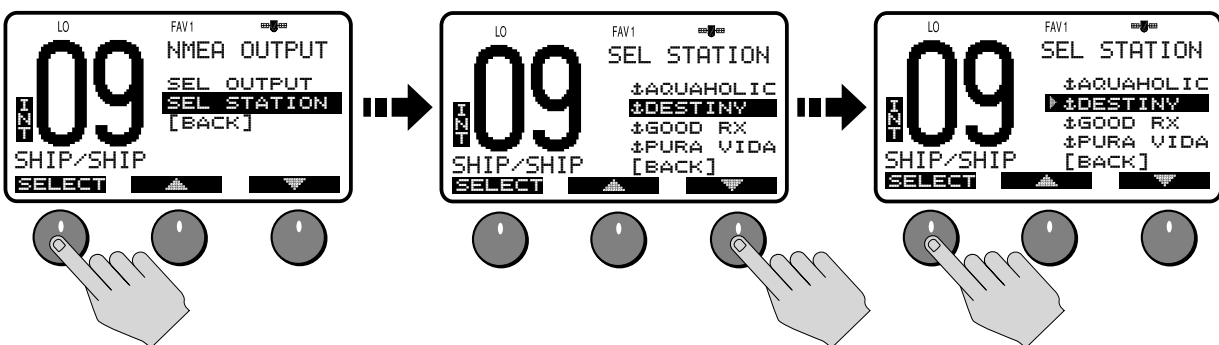

4.5 ATIS Operation

If you purchased your Ray218E/Ray55E to include use on the inland waterways of the contracting governments of the Basel Agreement, your radio has been programmed by your dealer to include Automatic Transmitter Identification System (ATIS) functionality. (The Basel Agreement includes Germany, Austria, Belgium, Bulgaria, Croatia, France, Hungary, Luxembourg, Moldova, the Netherlands, Poland, Romania, Russian Federation, the Slovak Republic, Switzerland, the Czech Republic, Ukraine and the Federal Republic of Yugoslavia.)

This section describes how to setup and activate ATIS in your radio.

My ATIS ID

ATIS includes data at the end of radio transmission that identifies your station. Your ATIS ID number is derived from your vessel's call sign. If your call sign is suitable, your authorized Raymarine dealer can assist you in decoding the number. You can then program the ATIS number into your Ray218E/Ray55E using the operation described in this section. If regulations in your area do not permit you to program the ATIS number yourself, you can have your dealer program the number for you.

Note: *The ATIS ID number is a ten digit number, beginning with a "9". The MY ATIS set up process has you input only the last 9 digits. The leading "9" is automatically input for you but does not appear on the display.*

This is a one time operation. After the ATIS number has been programmed:

- you will not be able to change it, only your dealer/distributor can do this
- accessing this menu item will display the programmed ATIS number

To enter or view the ATIS ID number:

1. From the Main Menu item, select ATIS OPS.
2. From the ATIS OPS menu item, select MY ATIS ID. If an existing ATIS ID is stored, the value appears. If the ATIS ID is blank, dashes appear, indicating that one has yet to be entered.
All ATIS ID numbers begin with a "9". The leading 9 is automatically input for you but does not appear. You enter the remaining nine digits.
3. To enter the ATIS ID number, rotate the **CH/OK** knob to select the digits and push in the **CH/OK** knob to confirm and move on to the next position.
A more-detailed description of manual character entry can be found in "Adding a new Entry" on page 79.
4. When all digits are selected, press DONE to accept.
You are prompted to re-enter the ID number.

5. Re-enter all the ATIS digits to confirm.
6. If the second entry does not match the first entry, a warning message is displayed and you are prompted to press BACK, and then retry.
7. When complete, press DONE to accept. The PROGRAMMING SUCCESSFUL screen appears.
8. Press DONE one last time to save the ID number and return to the ATIS OPS screen.

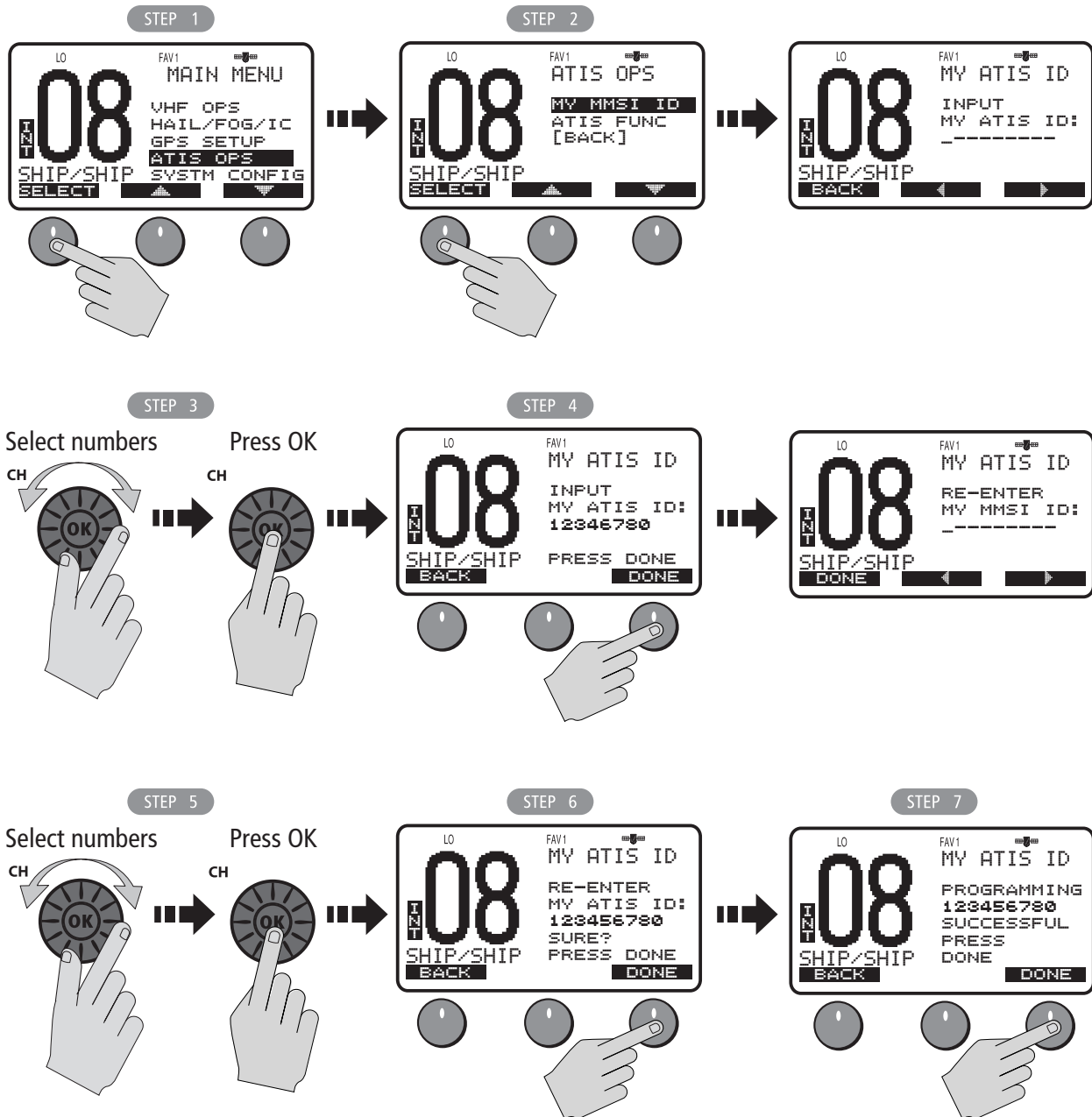

ATIS Function

This operation enables or disables the ATIS feature in the radio. This feature accommodates users who travel outside the inland waterways and wish to disable the ATIS function at that time.

Note: *If you purchased your Ray218E/Ray55E to include use on the inland waterways of the contracting governments of the "Regional Arrangement Concerning the Radiotelephone Service on Inland Waterways" – also known as the Basel Agreement – your radio has been programmed by your dealer to include ATIS. If ATIS is enabled, certain programming steps have been implemented to protect the integrity of this agreement, including the blocking of DSC functions when ATIS is active.*

When ATIS is enabled, the following occurs:

- DSC functions are disabled.
- Dual Watch, Tri Watch and all Scan functions are disabled.
- The following International Channels are limited to 1 watt output power: 6, 8, 10, 11, 12, 13, 14, 15, 17, 71, 72, 74, 75, 76, 77 (and 31, if enabled).

To enable/disable ATIS:

1. From the ATIS OPERATION menu, select ATIS FUNC.
2. Use the up/down arrow soft keys to set the ATIS function ON or OFF.
3. Press SELECT.
4. Press the DONE soft key to accept.
 - If set ON, the ATIS icon appears and DSC functions are disabled.
 - If set OFF, the ATIS icon disappears and DSC functions are enabled.

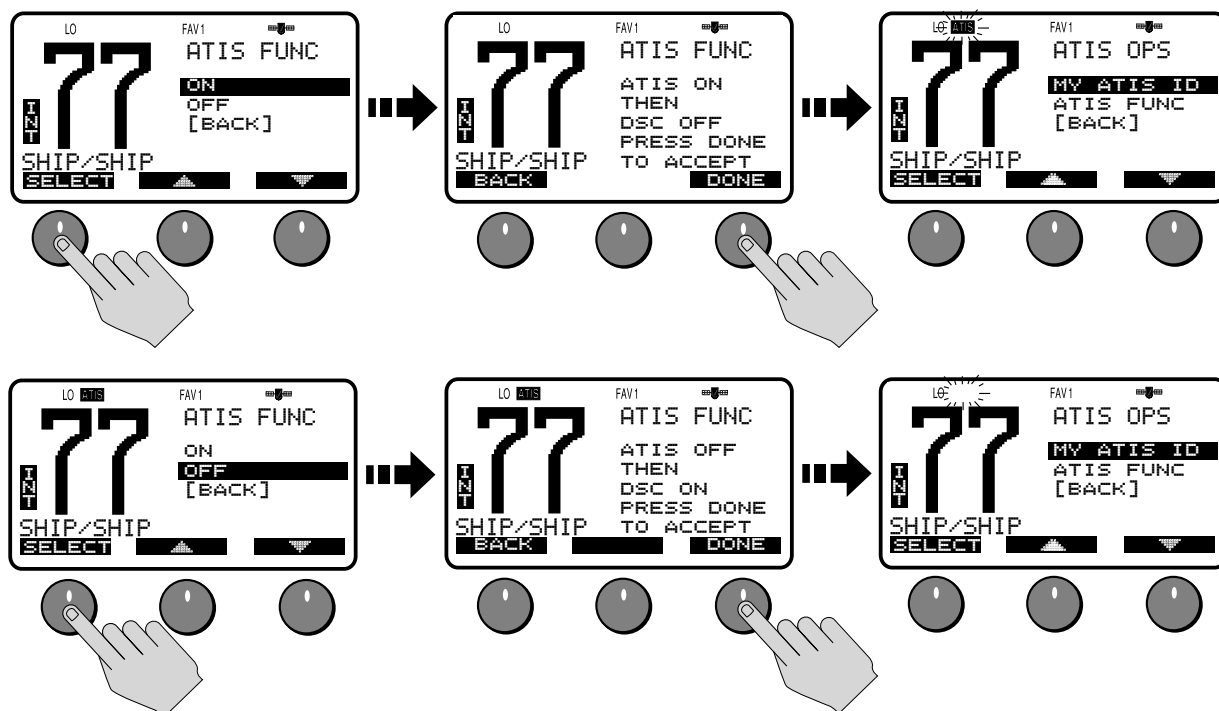

4.6 System Configuration

Use these menu items for selecting general system-wide settings.

Backlight Adjustment

This setting adjusts the backlight brightness for the LCD, microphone keypad and transceiver keypad. Choose from 10 brightness settings or OFF.

Rotate the **CH/OK** knob or use the up/down arrow soft keys to select the desired backlight level. The number of blocks illuminated in the bar indicates the level, one through ten. For HI all 10 are illuminated; for OFF none are illuminated.

Press SELECT or push the **CH/OK** knob to accept.

Separate backlight settings are maintained for the transceiver and the Raymic handset. When the backlight level is being adjusted in the transceiver, a message appears on the Raymic indicating that the base is busy. A similar message appears on the base LCD when adjusting the backlight on the Raymic.

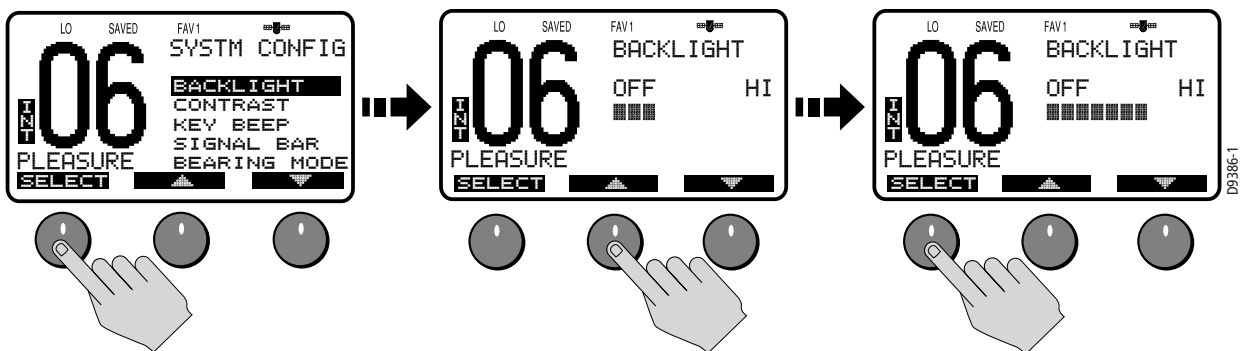

Contrast Adjustment

This setting adjusts the levels of LCD contrast. Choose from 10 settings.

Rotate the **CH/OK** knob to select the desired contrast level. The number of blocks illuminated in the bar indicate the level. A larger number of blocks indicate a darker LCD. For HI, all 10 blocks are illuminated; for LO none are illuminated.

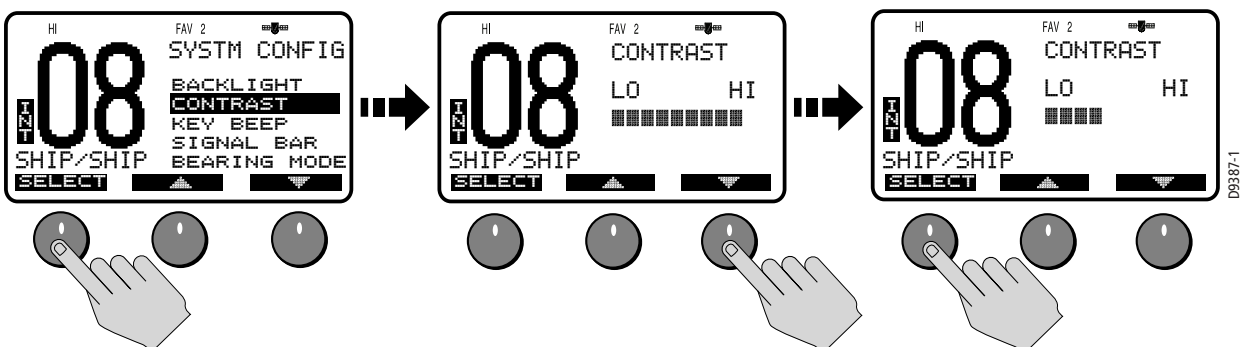

Key Beep

This setting is used to set the volume of the beep that sounds when a key is pressed. Select LOUD, QUIET or OFF.

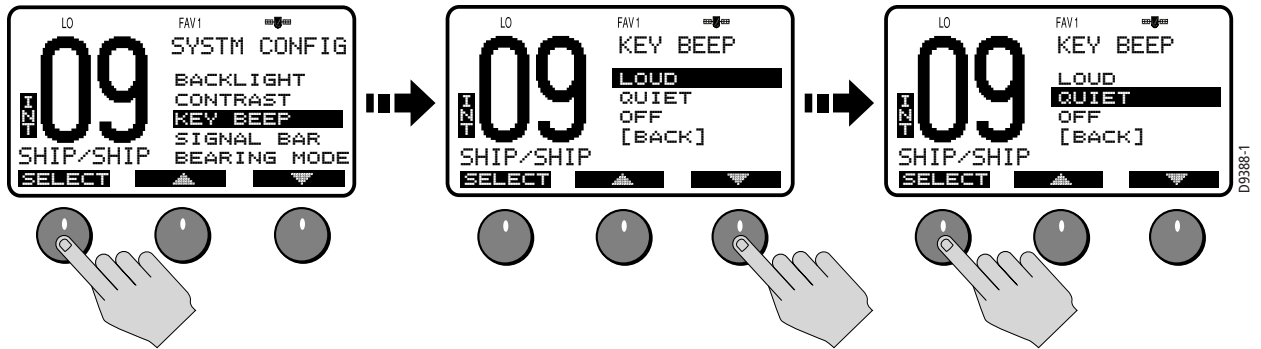

Signal Bar

Use this setting to determine whether the signal strength bar is displayed to the left of the channel number. Select from ON or OFF.

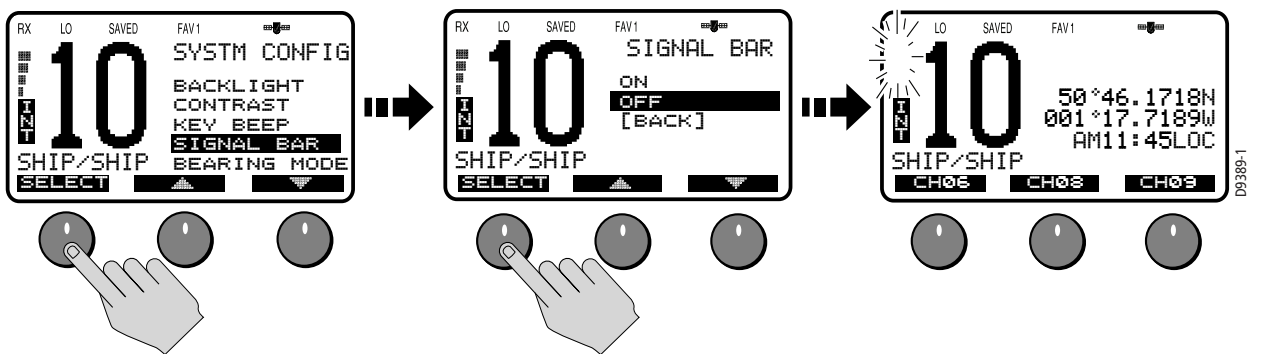

Bearing Mode

This setting is used to determine how heading data are displayed when COG/SOG is displayed (see page 61). Select MAGNETIC or TRUE. If you select MAGNETIC, an "M" appears. If TRUE is selected, a "T" appears.

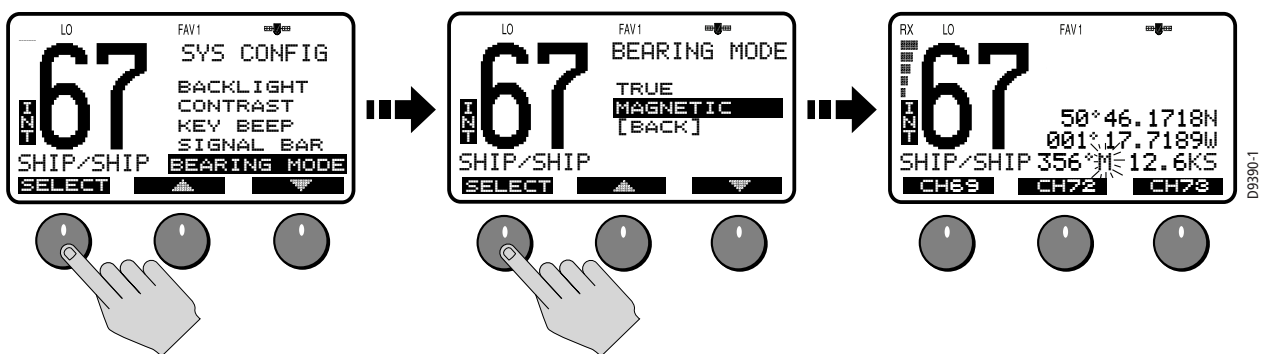

Speed Unit

This parameter sets the unit for Speed that is used to display all data, including information received from other instruments on the system. The speed unit appears on the LCD when COG/SOG is displayed (see page 61).

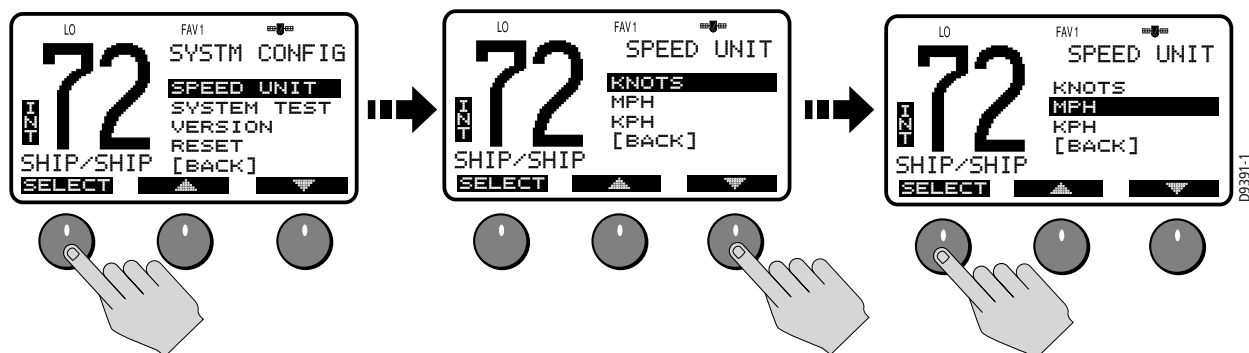

System Test

This menu item displays status of four separate conditions:

Item	Status	Meaning
GPS	OK	Valid NMEA signal received
	NO	NMEA signal not received
RAYMIC	OK	Raymic second station is connected
	NO	Raymic is not connected
HAILER	OK	Hailer horn speaker is connected
	NO	Hailer is not connected
BATTERY	OK	Battery voltage within nominal limits (10.5–15.8 VDC)
	NO	Battery is below 10.5 VDC or above 15.8VDC
DSC	OK	DSC processor is operating properly.
	NO	DSC processor is not operating properly.

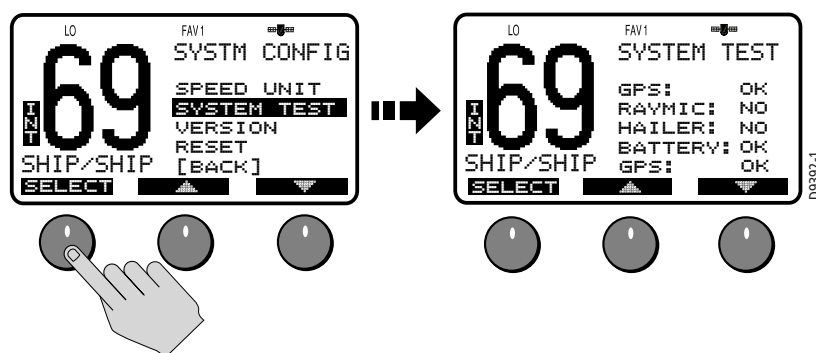

Version Number

This menu item displays the hardware and software versions of your radio.

Reset

Use this menu item to return your radio to the default factory settings. The following items are reset. All other settings are unaffected.

VHF OPS

- **DISPLAY MODE**
Set to 1 UP CHANNEL.
- **HI/LO POWER**
Set to HI.
- **SAVE CHANNEL**
The Saved Channel list is cleared.
- **CHANNEL NAME**
The Long Channel Name list is displayed.
- **SENSITIVITY**
Set to DISTANT.

GPS SETUP

- **SETTING**
LAT/LON DISP is set ON.
TIME DISPLAY is set ON.
TIME OFFSET is set to 0.
TIME FORMAT is set to 24 HR.
COG/SOG is set OFF.
- **NMEA OUTPUT**
SEL OUTPUT is set to ALL STATION.

SYSTEM CONFIG

- **KEY BEEP**
Set to QUIET.
- **SIGNAL BAR**
Set to ON.
- **BEARING MODE**
Set to TRUE.
- **SPEED UNIT**
Set to KNOTS.

DSC MENU

- **REC'D CALLS**
All logs are cleared.
- **DSC SETUP**
AUTO CH CHANGE is set ON.

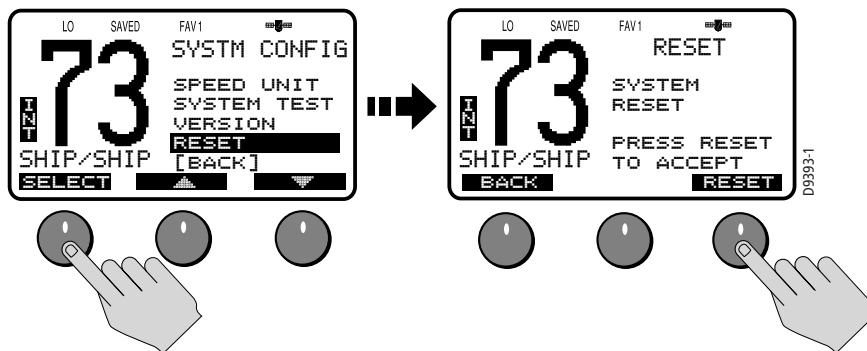

Chapter 5: Digital Selective Calling (DSC)

The Ray218E/Ray55E includes equipment for Class “D” Digital Selective Calling (DSC). DSC protocol is a globally applied system used to send and receive digital calls. DSC uses a unique Maritime Mobile Service Identity (MMSI) number to direct DSC calls directly to your radio, much like a telephone number.

Note: An MMSI number is required to operate the DSC equipment in this radio. You can request an MMSI number from the same agency that issues radio or Ship Radio licences in your area. Once obtained, you can program the MMSI number yourself one time only using the operation described in “My MMSI ID” on page 96. Otherwise, your Raymarine dealer can program or change the number for you.

The Ray218E/Ray55E includes a separate dedicated receiver just for DSC communications on channel 70. When a DSC call is received, the radio automatically responds based on the type of call. When receiving a DSC call from another vessel or a coast station, an alert sounds and DSC data appears in the LCD—such as time of a call, the caller and the type and priority of a call.

Note: If you purchased your Ray218E/Ray55E to include use on the inland waterways of the contracting governments of the “Regional Arrangement Concerning the Radiotelephone Service on Inland Waterways”—also known as the Basel Agreement—your radio will be programmed by your dealer to include Automatic Transmitter Identification System (ATIS) functionality. If ATIS has been enabled, certain programming steps have been implemented to protect the integrity of this agreement, including the blocking of DSC functions when ATIS is active. See “ATIS Function” on page 65.

5.1 DSC Call Menu

You access DSC functions via the DSC menu. Press and hold the **MENU/DSC** key for 3 seconds to enter DSC call mode.

Note: Distress calls are made using the **DISTRESS** key.

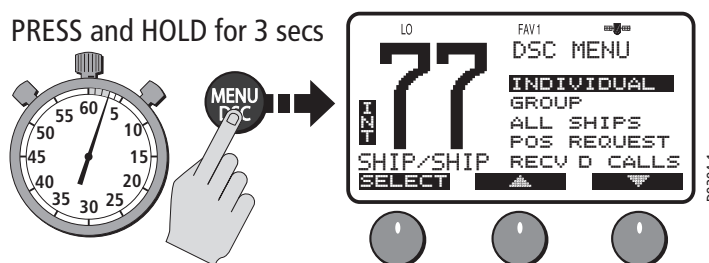

The Ray218E/Ray55E can make the following type of DSC calls:

DSC Call Type	Description
DISTRESS	Sends out your MMSI number and nature of your Distress along with the position and time information from the input NMEA data. This digital information lets other ships and shore stations equipped with appropriate DSC equipment know where you are and that you are in a Distress situation. Distress Calls are made using the DISTRESS key.
INDIVIDUAL	Makes a ROUTINE DSC call to a specific station identified by its MMSI number.
GROUP	Sends transmissions that are only received by radios sharing a common Group MMSI number. Up to 5 Group MMSI numbers can be stored and called.
ALL SHIPS	Sends out a message to all stations within range that you have important information but the situation is not serious enough for a Distress Call. There are two types of All Ships Calls: SAFETY for advisory alerts and URGENCY for assistance when life is not in immediate danger.
POSITION REQUEST	This option enables you to request GPS position information from any vessel for which an MMSI number is known. You can specify the target vessel either by selecting it from your MMSI phonebook or by manually entering its MMSI number. You can also be requested to send out your position to someone else.
RECEIVED CALLS	Three separate logs listing all received DSC Call types by number and time of call. Entries are separated into the following: Distress Log, Call Log for all other types of DSC Calls, and Position Log. NOTE: You can place a call directly from a log to the station that is currently displayed. You can also add the displayed station to the DSC Phonebook.

Note: To conform with regulations of the Basel Agreement for radiotelephone service on inland waterways, DSC functions are disabled when ATIS is active. Please see "ATIS Function" on page 65.

Making DSC Menu and Programming Selections

There are three ways to make DSC menu and character selections in your radio:

1. Most examples in this chapter describe making selections using the **CH/OK** knob and soft keys on the transceiver.
2. However, you can also press the microphone up/down keys to make your selections and then press the microphone **HI/LO** key to accept.

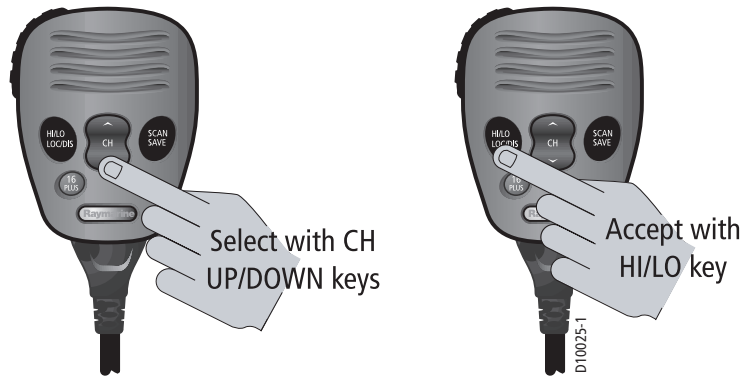

- 3. Alternatively, if you have an optional Raymic, you can use its **CH** up/down keys to select and **OK** key to accept.

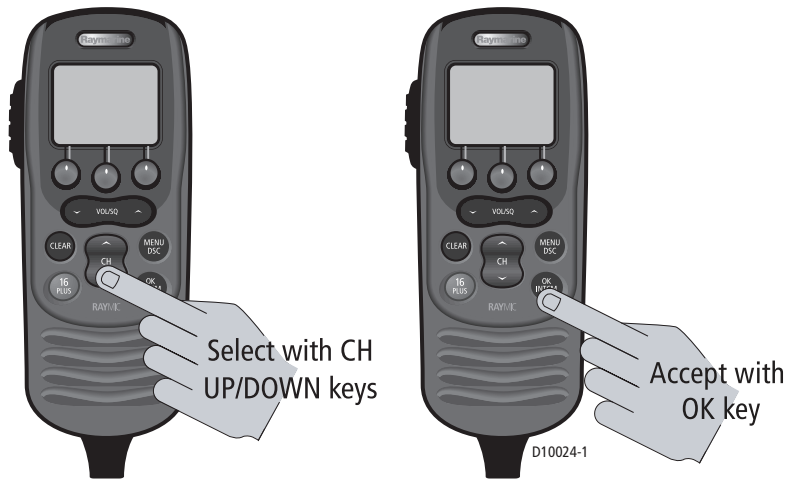

5.2 Distress Calls

For a Distress Call transmission, the Ray218E/Ray55E takes the position and time information from the input NMEA data along with your MMSI and converts it into a digital "packet". When transmitted, this digital information lets other ships and shore stations equipped with appropriate DSC equipment know where you are and that you are in a Distress situation.

Your call can specify the nature of the Distress (designated call) or not (undesignated call).

Sending a Distress Call

Lift the spring-loaded door on the front panel of the transceiver.

Undesignated (Quick) Distress Call

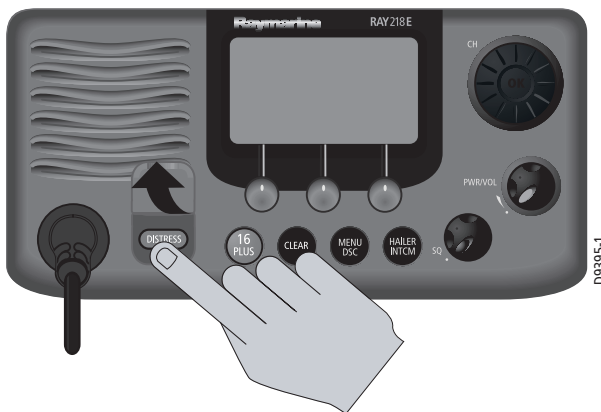

To send a distress call without specifying its nature:

- Press and hold the red **DISTRESS** key for 3 seconds to initiate the call. During this time, the radio beeps, the display flashes and a timer counts down 03...02...01.

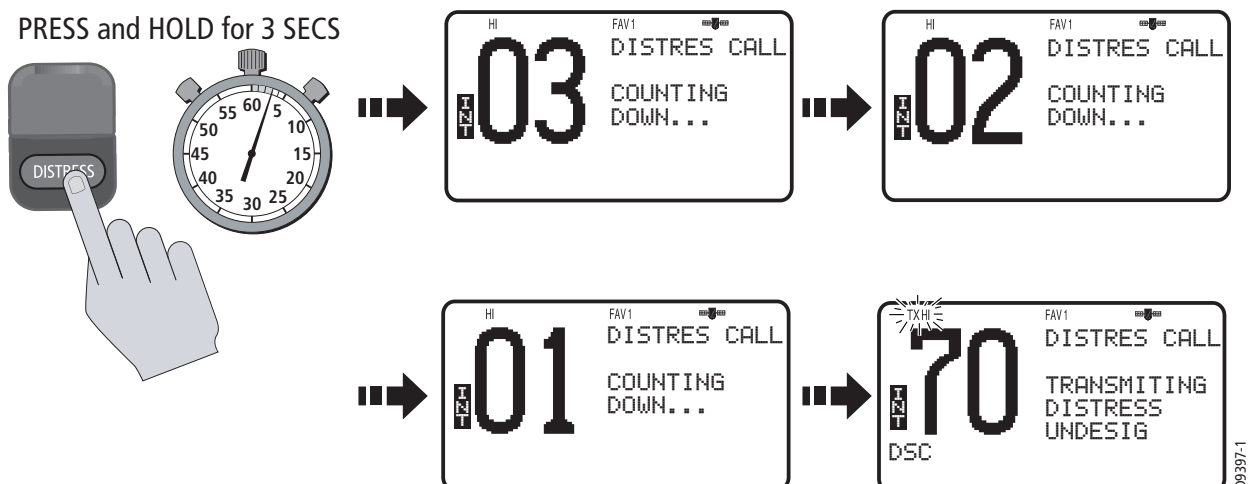

Designated Distress Call

To send a distress call and specify its nature:

1. Press the red **DISTRESS** key.
2. Release the **DISTRESS** key.
The Distress Call screen appears.
3. Rotate the **CH/OK** knob or press the up/down arrow soft keys until the type of Distress you wish to designate is highlighted:
 - UNDESIGNATED
 - FIRE
 - FLOODING
 - COLLISION
 - GROUNDING
 - CAPSIZING
 - SINKING
 - ADRIFT
 - ABANDONING
 - PIRACY
 - MANOVERBOARD
 - EXIT
4. Press SELECT to choose that type of Distress.
5. Press and hold the **DISTRESS** key for 3 seconds to initiate the call. During this time, the radio beeps, the display flashes and a timer counts down 03...02...01... , just as with the undesignated call illustrated above.

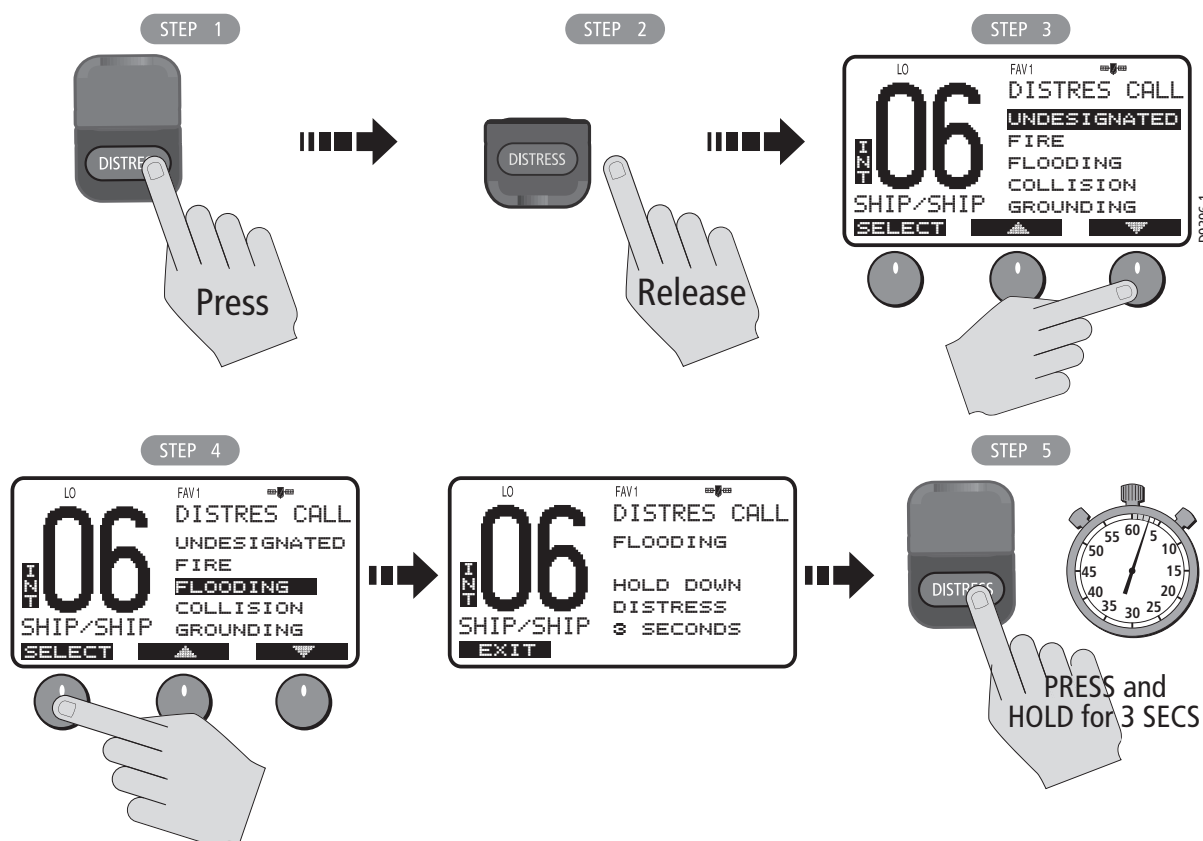

Note: To conform with regulations of the Basel Agreement for radiotelephone service on inland waterways, DSC functions are disabled when ATIS is active. See "ATIS Function" on page 65.

Transmitting

After the Distress transmission, the radio is automatically set to channel 16 at high power to listen for and respond to voice replies from Search and Rescue authorities or other vessels that may have received your Distress Call.

To mute the alarm:

Press **CLEAR**.

To manually cancel the automatic Distress resend:

Press **CLEAR** a second time.

The Distress Call is resent randomly every 3.5 – 4.5 minutes until an acknowledgement is received or the call is manually cancelled.

Receiving Acknowledgement

After the call is sent, the radio waits for acknowledgement. The display stops flashing and the alarm sounds continuously until muted or an ACK is received.



Cancelling a Distress Call Made in Error

If the countdown has not been completed, release the **DISTRESS** key before the countdown has completed.

If the countdown has completed and the distress call has been sent in error, you should make an announcement as soon as possible that the distress situation does not exist.

1. Immediately press **CLEAR two times** to cancel the Distress Call. The radio returns to the state before the Distress Call.
2. Press the **16/PLUS** key. The radio switches to the Priority Channel.
3. Make a broadcast to all stations giving your ship's name, call sign and MMSI number and cancel the false distress alert. For example:

"All Stations, All Stations, All Stations. This is NAME, CALL SIGN, MMSI ID, POSITION. Cancel my distress alert of DATE, TIME, NAME, CALL SIGN."

Receiving a Distress Call

The Ray218E/Ray55E receives distress messages sent by another vessel and/or acknowledgments (ACK) sent by a coast station to another vessel in distress. The radio also receives distress relays.

Note: *Class “D” DSC radios such as the Ray218E/Ray55E are forbidden by law from automatically acknowledging or relaying DSC distress calls. Upon receiving a distress call, you may hail the vessel in distress on channel 16 and standby to lend assistance if requested.*

When a Distress Call is received, the Ray218E/Ray55E automatically tunes to channel 16 and sounds the Distress Alarm Tone. (If you have disabled automatic channel changing, as described on page 98, you are first prompted whether to accept the call.)

Two alternating screens appear in the display. When position data and time is included within the signal, it is displayed on the first screen in the text area of the LCD. The second screen shows the nature of the distress and time it was sent.

The 2 alternating pages of data are recorded in the Distress Log. The envelope icon (✉) blinks until you accept the call, reject the call, or open the resulting unread message stored in the Log. See page “Received Calls (Logs)” on page 94.

Your radio has the capability of forwarding position data from a Distress Call to your display unit (C Series, E Series, etc.) over the NMEA port so that it can be displayed on the screen. You can specify which stations will have their position data information sent to the display unit using the option NMEA Output, which is described on page 61.

To mute the alert tone:

Press **CLEAR**.

To ignore the Distress Call:

Press **CLEAR** a second time or press the CANCEL soft key. The envelope icon disappears, the call is interrupted and the normal screen appears on the LCD.



To accept a Distress Call when Auto Channel Change is OFF

1. Press the OK soft key or the **CH/OK** knob. The alert tone is muted, the envelope icon disappears and the radio switches to channel 16.
2. Press OK again to confirm the channel change. The radio returns to standby mode. Press **PTT** to communicate on channel 16.

To accept a Distress Call when Auto Channel Change is ON

Press the OK soft key or the **CH/OK** knob. The alert tone is muted, the envelope icon disappears and the radio automatically switches to channel 16. Press **PTT** to communicate.

...with Auto Channel Change OFF

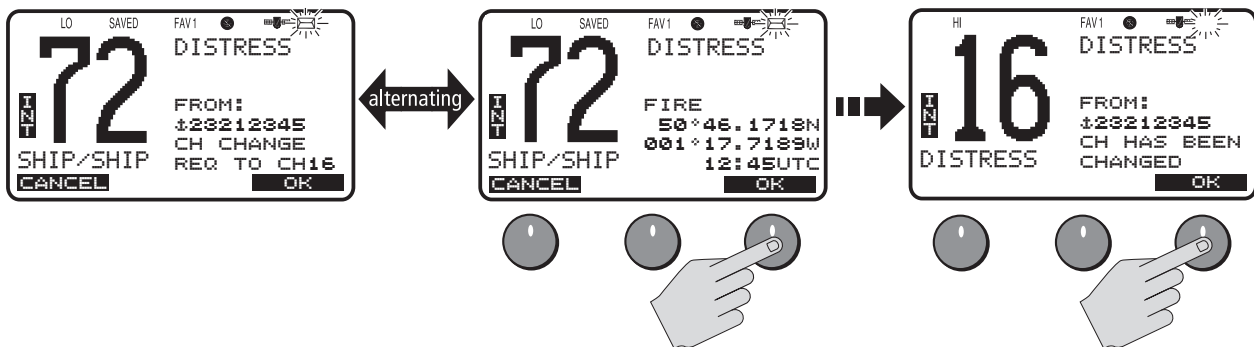

...with Auto Channel Change ON

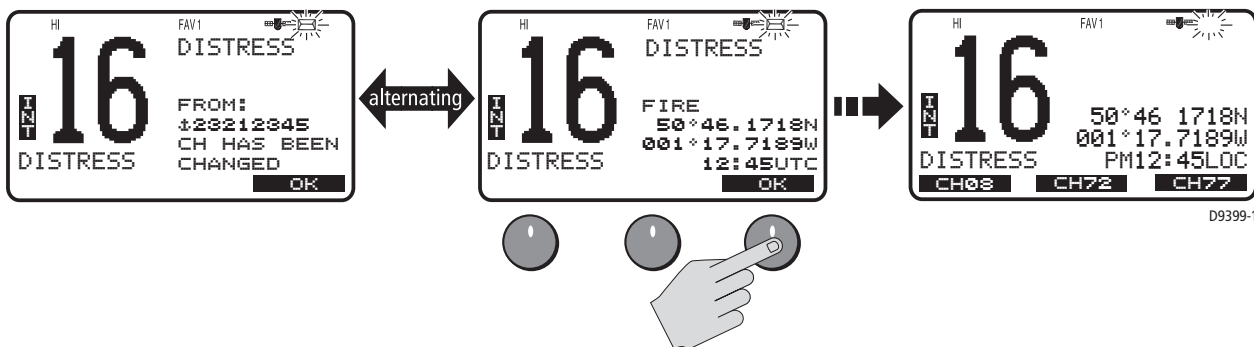

D9399-1

Note: The *AUTO CH CHG* option determines whether you want your radio automatically switched to channel 16 to receive the call or instead to be prompted to manually receive or decline the channel change. See page 98.

Receiving a Distress Relay Sent by Another Station

When a Distress Relay is received, an alarm sounds, the envelope icon blinks and the LCD displays two alternating screens. The first page displays the Name/MMSI ID of the station sending the message. Page 2 displays the Name/MMSI ID of the vessel in distress and its lat/lon position. Your radio does not re-send a distress relay message.

5.3 DSC Phonebook

The Phonebook stores up to 50 preprogrammed MMSI numbers that you can select for making an Individual Call. The numbers are stored by name and contain the station's MMSI number. You can add, edit and delete entries from the Phonebook, much as you would on a cellular telephone. Rotate the **CH/OK** knob to make an item appear on the dot matrix display and then press in **CH/OK** to select that item.

Adding a new Entry

1. Select PHONEBOOK from the DSC menu. The list of Phonebook entries appears. Highlight <NEW>. If no entries have yet been entered, this is your only choice.
Press SELECT. You are prompted to enter the MMSI number for the new entry. The first character space to be modified is highlighted with a flashing underline.



2. Rotate the **CH/OK** knob. The flashing underline is replaced with a numeric character. Continue rotating the knob to scroll through the selections.
3. When the appropriate number appears, press the **CH/OK** knob to accept. The next character to be filled in sequence is then underlined.

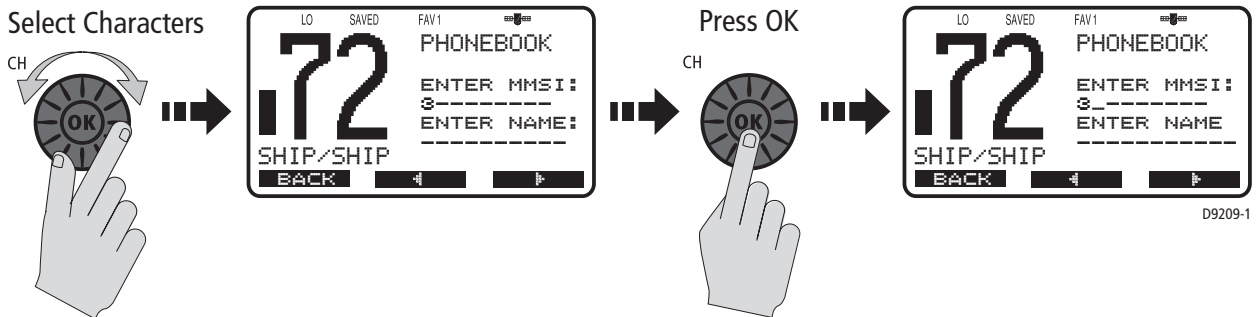

4. Continue this process until all MMSI digits have been entered. Use the < and > soft keys to edit selected characters, if necessary.

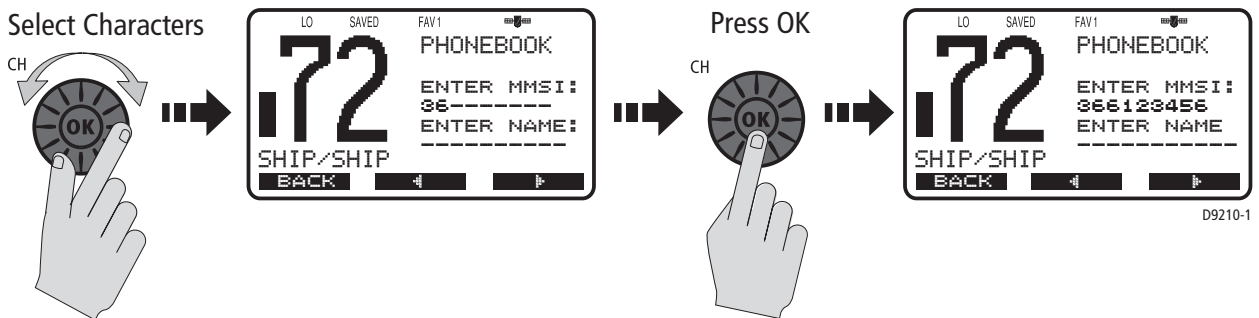

5. When you press the **CH/OK** knob to accept the final MSSI ID digit, the cursor moves on to the NAME field. The first character in this line is a symbol assigned by the radio, based on the MMSI number you entered. Coast Stations are identified by "00" at the beginning of the station name. If you enter 00 as the leading digits of the MMSI ID, the radio recognizes this as a coast station and automatically enters a tower symbol (⚓). If you enter a number other than 0 in the initial position of the MMSI ID, an anchor symbol (⚓) is entered as a prefix to the name, identifying this as a Ship Station. The first character space to be modified is highlighted with a flashing underline. Using the same procedure as above, rotate the **CH/OK** knob to select the NAME characters. All alpha and numeric characters are available, as well as 13 symbols: ! # % ' () : ? / . , + -
- Press the **CH/OK** knob to accept. Continue this process until all NAME characters have been entered.

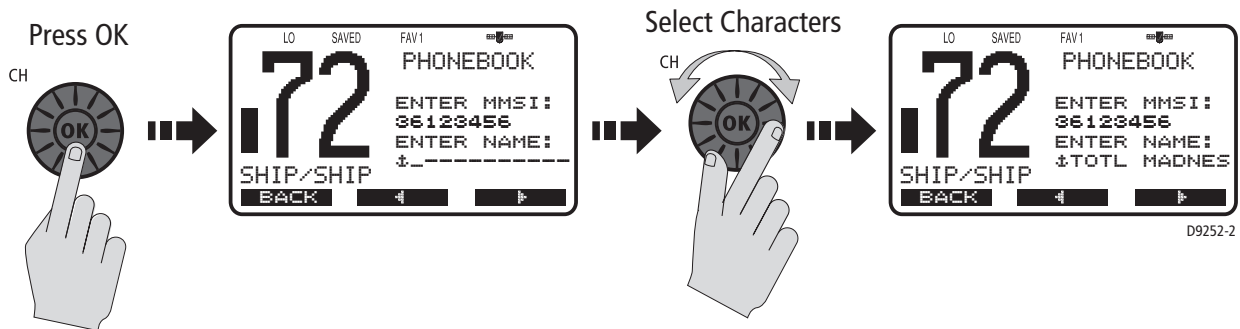

6. When complete, press the DONE soft key to accept. The new entry appears in the list.

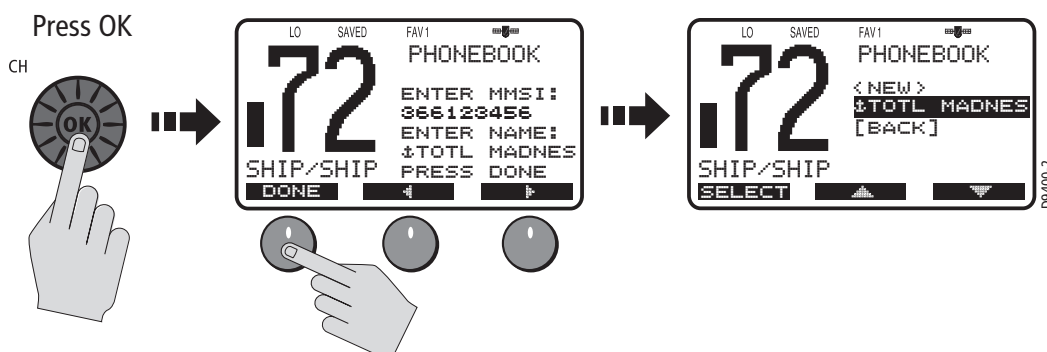

Editing an Existing Entry

1. From the Phonebook, rotate the **CH/OK** knob or press the ⚓ and ⚓ soft keys until the entry you wish to edit is highlighted.
2. Press SELECT. The list of options appear.
3. Highlight EDIT and press SELECT.
4. Make your changes to the NAME and MMSI ID, using the **CH/OK** knob.
5. When finished, DONE to save your changes. The revised name or MMSI number appears in the list.

Deleting an Existing Entry

1. From the Phonebook, rotate the **CH/OK** knob or press the **↵** and **⏏** soft keys until the entry you wish to delete is highlighted.
2. Press SELECT. The list of options appear.
3. Highlight DELETE and press SELECT again. You are prompted to confirm your selection.
4. Press DELETE. The entry is removed from the list.

5.4 Individual Calls

The Ray218E/Ray55E can make Individual Routine calls.

Making DSC Calls to Coast Stations

The examples in this handbook illustrate making DSC calls to Ship Stations. However, the procedures for making Individual Calls to a Coast Station are different. Calls to a Ship Station require that you enter a subsequent working channel chosen from a pre-programmed list offered to you by the Ray218E/Ray55E. Calls to a Coast Station remove this step from the operating procedures. The Coast Station controls and indicates the subsequent working channel within its acknowledgement.

The Ray218E/Ray55E automatically detects the correct procedures for you based on the type of MMSI number you enter manually or with or the phonebook. If "00" is detected as the first two characters of the MMSI, Coast Station procedures are implemented automatically.

Note: *When making a call to a coast station, you will not be asked to select a working channel because that will be provided by the coast station.*

Transmitting an Individual Call

To make an Individual Call to a ship or coast station, you must select the specific MMSI number to contact and the working channel to be used for the call. The MMSI ID can be entered manually or selected from a Phonebook list of preprogrammed numbers specified using the MENU function, as follows:

1. From the DSC menu, rotate the **CH/OK** knob or press the **↵** and **⏏** soft keys until INDIVIDUAL is highlighted, and push the **CH/OK** knob or press SELECT. The Individual Routine menu appears, which displays any Phonebook entries you have saved and <MANUAL> for manual number entry.
2. Rotate the **CH/OK** knob or press the arrow soft keys until the desired individual name is highlighted.
3. When the desired name is highlighted, press SELECT.

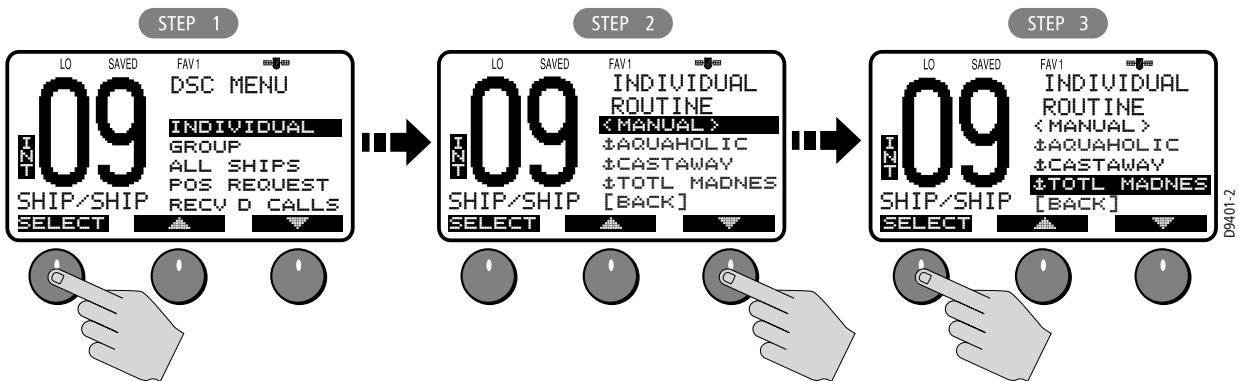

If using MANUAL MMSI ID entry:

Enter the MMSI number using the **CH/OK** knob. Rotate **CH/OK** to select each character and then push in **CH/OK** to accept. The next position to be modified is indicated by a blinking underline. A more-detailed description of manual character entry can be found in "Adding a new Entry" on page 79.

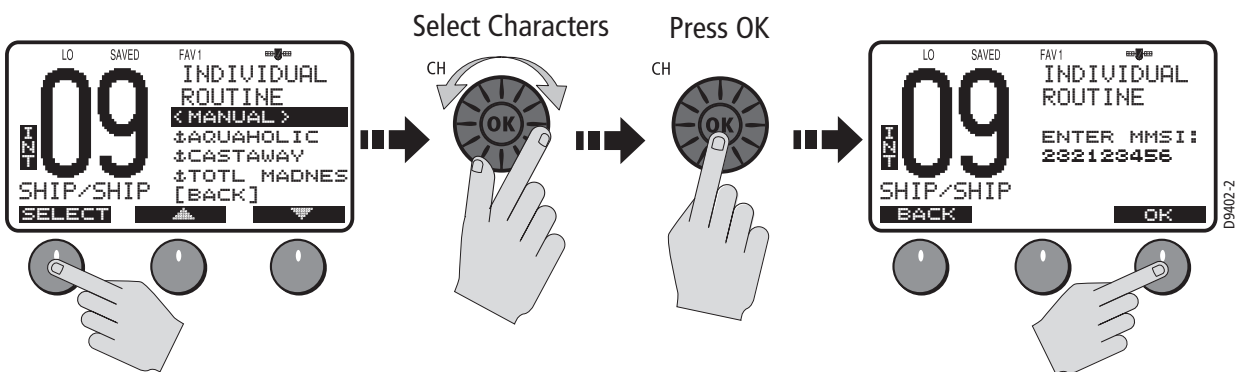

4. Press OK to initiate the call.
5. Rotate the **CH/OK** knob to select the working channel to be used for the Individual Call and press OK. Select from 06, 08, 09, 10, 13, 15, 16, 17, 67, 68, 69, 71, 72, 73, or 77.

Note: *Individual Calls to a Coast Station remove this step from the operating procedures. The Coast Station controls and indicates the working channel within its ACK.*

6. Press SEND to transmit the call. The Individual Call is transmitted on channel 70, the radio tunes to the original channel and waits for acknowledgement. During this period you are still able to receive calls.
7. When the acknowledgement is received, the radio automatically switches to the selected working channel and sounds a DSC Call alert ring. Press OK to confirm.

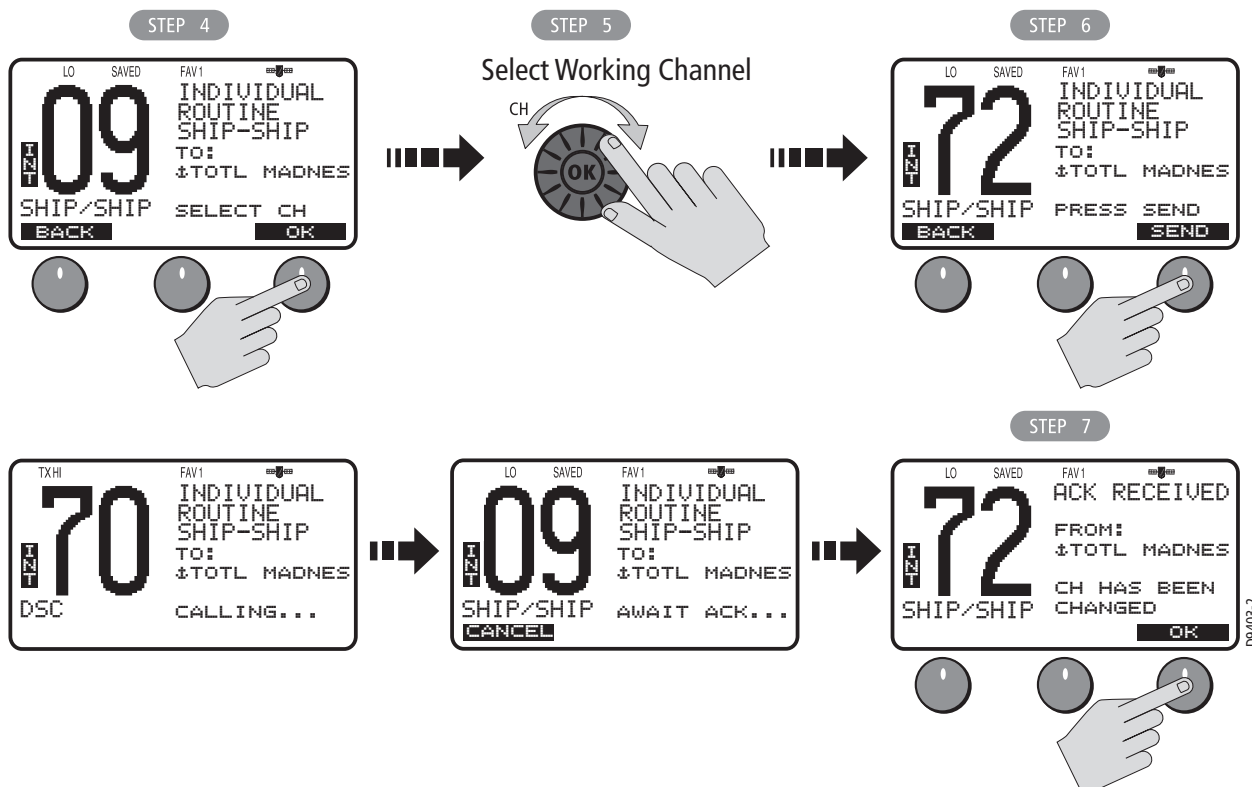

Press **PTT** to communicate on the specified channel. Pressing PTT at any time before an ACK is received cancels the Individual Call

Receiving Individual Calls

When an Individual Call is received, an alert tone sounds, the envelope icon blinks, and the LCD alternates between a screen displaying the name (or MMSI ID) of the station initiating the call and one indicating that a request for a change of working channels is being made. The channel does not change until you accept.

The 2 alternating pages of data are recorded in the Call Log. The envelope icon (✉) blinks until you accept the call, reject the call, or open the resulting unread message stored in the Log. See page "Received Calls (Logs)" on page 94.

To mute the alert tone:

Press **CLEAR**. Automatic cancellation takes place after 2 minutes.

To ignore the Individual Call:

Press **CLEAR** a second time or press the CANCEL soft key. The envelope icon disappears, the call is interrupted and the normal screen appears on the LCD.

To accept an Individual Call:

1. Press the OK soft key to change channels to the one designated by the caller. The alert tone is muted and the envelope icon disappears.
2. If the caller requests an acknowledgement, press OK to accept.

3. Press SEND to comply with the ACK.
4. When the caller responds to the ACK, press OK to return to standby mode.
Establish voice communications on the designated channel by pressing **PTT**.

If the caller requests that you change to an unsupported working channel the message INVALID CHANNEL appears on the LCD. If an acknowledgement is sent, the originating station is sent the message UNABLE TO COMPLY, indicating that your radio could not make the requested channel change.

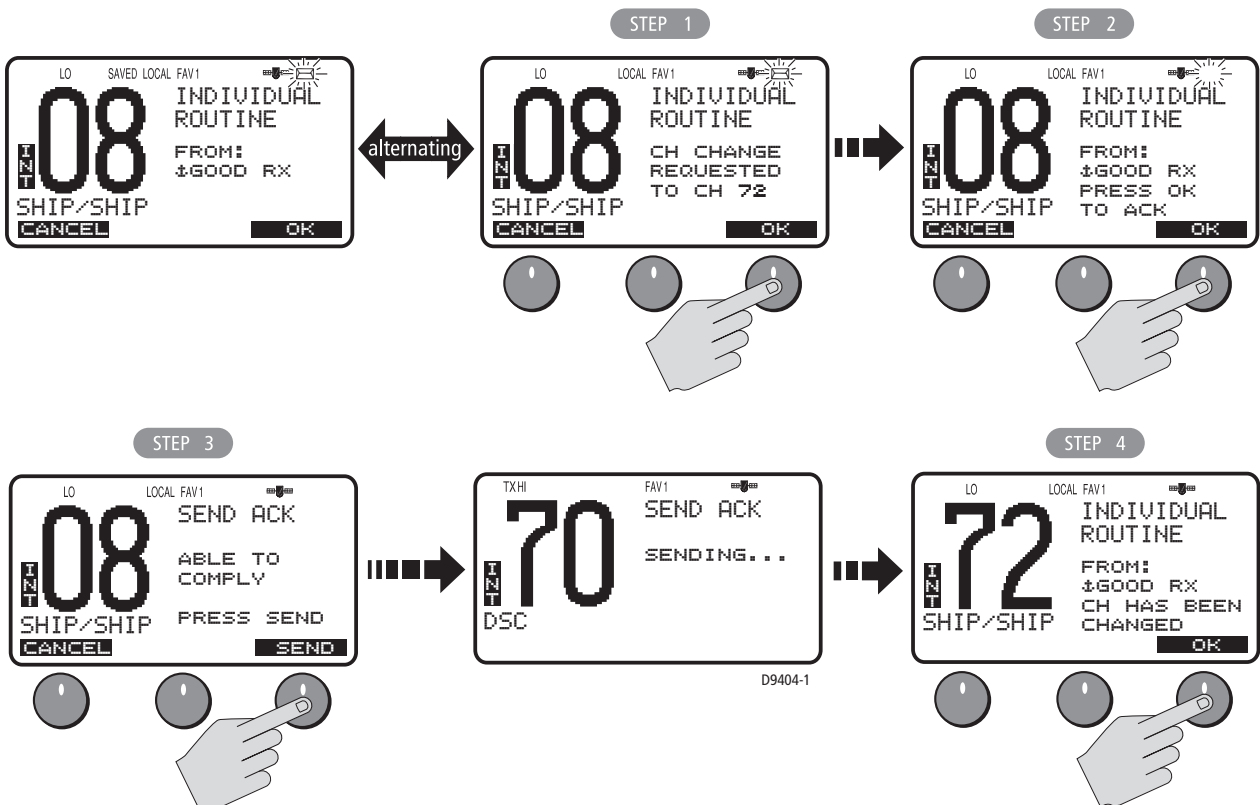

5.5 Group Calls

The Group Call feature sends transmissions that are only received by radios sharing a common Group MMSI number, such as a flotilla or racing fleet. The Ray218E/Ray55E sends Group Routine calls.

Group MMSI Setup

You can program up to five Group MMSI ID numbers and associated Group names, which can be up to 11 characters long. Group MMSI ID numbers always begin with a zero (0). You only enter the last 8 digits of the Group ID number; the initial "0" is automatically entered for you.

Adding a New Group

1. Select GROUP from the DSC Menu.
2. Select MY GROUP ID. If an existing Group name and MMSI ID number are already stored, those values appear. If blank, <EMPTY 1>, <EMPTY 2>, etc. are shown to indicate that the Group IDs have not yet been programmed. Select the first available empty group location. The first field for you to enter data is the GROUP MMSI number.
3. Fill in the GROUP MMSI field one number at a time. The leading "0" is automatically entered for you. The first character space you can modify is highlighted with a flashing underline. A more-detailed description of manual character entry can be found in "Adding a new Entry" on page 79.
4. Rotate the **CH/OK** knob. The flashing underline is replaced with a numeric character. Continue rotating the knob to scroll through the selections. Use the < and > soft keys to edit selected characters, if necessary.
5. When the appropriate number appears, press the **CH/OK** knob to accept. The next character to be filled in sequence is then underlined. Continue this process until all GROUP MMSI characters have been entered.
When you press the **CH/OK** knob to accept the final MSSI ID digit, the cursor moves on to the GROUP NAME. The first character space to be modified is highlighted with a flashing underline.
6. Using the same procedure as above, rotate the **CH/OK** knob to select the GROUP NAME characters. All alpha and numeric characters are available, as well as 13 symbols: ! # % ' () : ? / . , + -
7. Press the **CH/OK** knob to accept. Continue this process until all GROUP NAME characters have been entered.
8. When complete, press the DONE soft key to accept. The new entry appears in the list.

Use the same procedure to edit an existing entry in the list.

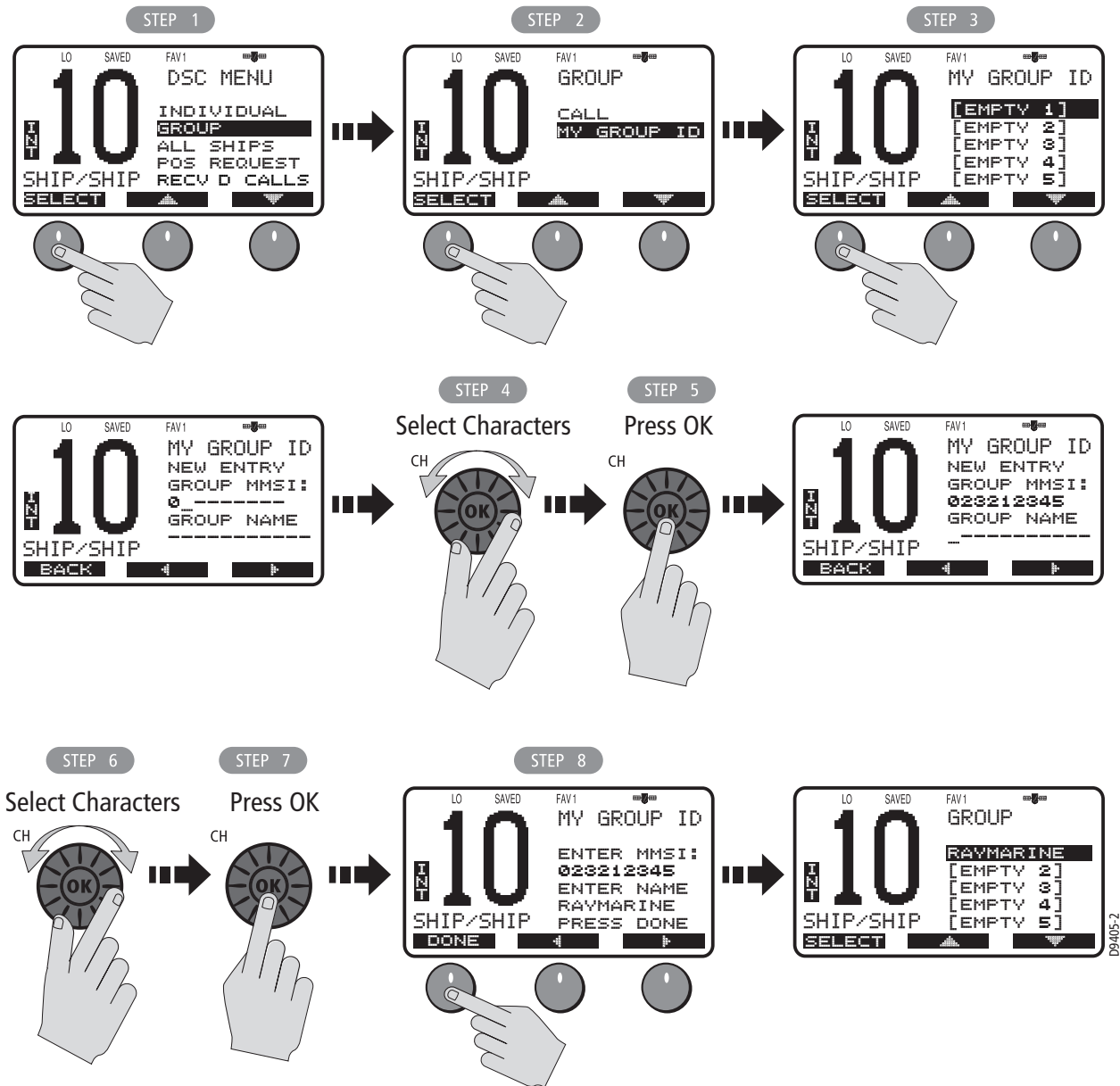

Transmitting a Group Call

To call another vessel in the group, select the Group Name to contact from the list of numbers described in the preceding section and the working channel to be used for the Group Call.

1. Select GROUP from the DSC menu.
2. Select CALL. The Group entries you have saved appear.
3. Highlight the group name you wish to call and press SELECT.
4. Press OK.
5. Rotate the **CH/OK** knob to select the working channel to be used for the call.

6. Press SEND to transmit the Group Call.
The Group Call is transmitted on channel 70, and the radio tunes to the designated working channel to be used for the Group Call.
7. Press OK to confirm that the working channel has been changed.

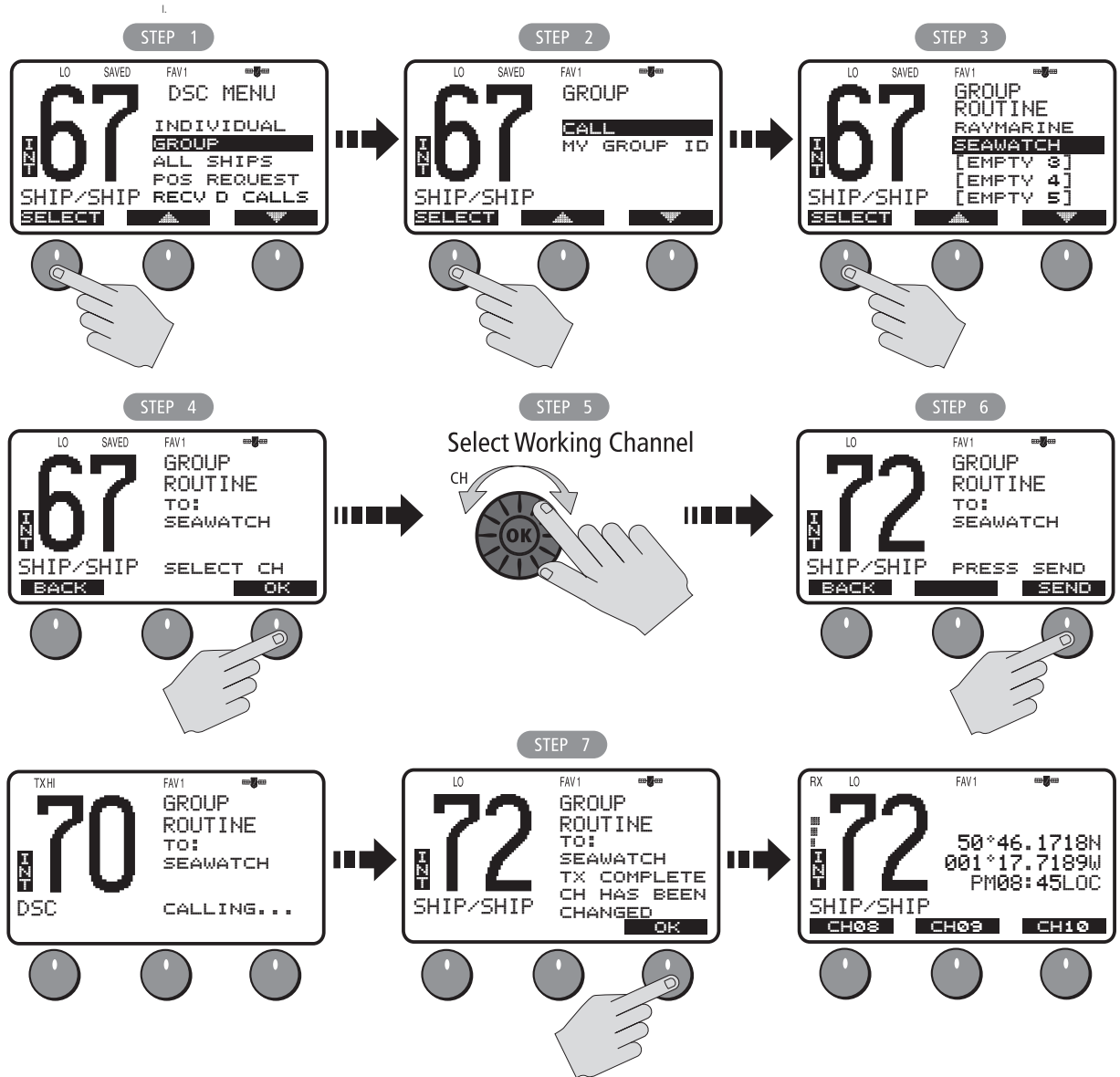

Receiving Group Calls

The Ray218E/Ray55E can receive Group Routine Calls from anyone in your prearranged group.

When a Group Call is received, the LCD alternates between a screen displaying the name (or MMSI ID) of the station in the group initiating the call and one indicating that a request for a change of working channels is being made.

The 2 alternating pages of data are recorded in the Call Log. The envelope icon (✉) blinks until you accept the call, reject the call, or open the resulting unread message stored in the Log. See page "Received Calls (Logs)" on page 94.

To mute the alert tone:

Press **CLEAR**. Automatic cancellation takes place after 2 minutes.

To ignore the Group Call:

Press **CLEAR** a second time or press the CANCEL soft key. The envelope icon disappears, the call is interrupted and the normal screen appears on the LCD.

To accept the Group Call:

1. Press the OK soft key to change channels to the one designated by the caller. The alert tone is muted and the envelope icon disappears.
2. If the caller requests an acknowledgement, press SEND to comply.
3. When the caller responds to the ACK, press OK to return to the standby mode. Establish voice communications on the designated channel by pressing **PTT**.

If the caller requests that you change to an unsupported working channel the message INVALID CHANNEL appears on the LCD. If an acknowledgement is sent, the originating station is sent the message UNABLE TO COMPLY, indicating that your radio could not make the requested channel change.

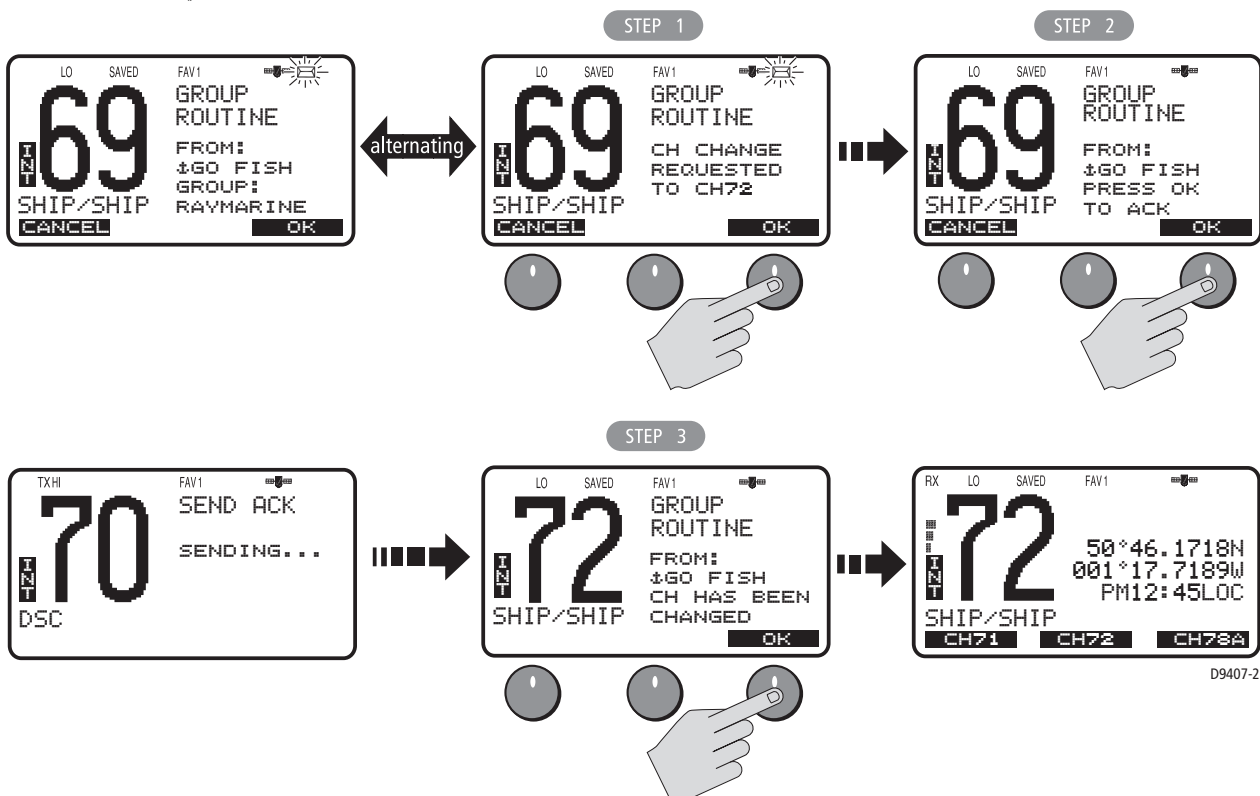

5.6 All Ships Calls

An All Ships Call sends out a message to all stations within range. The Ray218E/ Ray55E can make All Ships Safety Calls for advisory alerts and Urgency Calls when assistance is required but life is not in danger. For example, you might send a Safety Call to warn others there is a large floating object that may be a hazard to navigation. A sample Urgency Call might be that you have an illness or an accident on board. The All Ships Call is made on channel 70, and then the radio automatically switches to channel 16 at high power for voice communications.

Transmitting an All Ships Call

1. Select ALL SHIPS from the DSC menu.
2. Select the type of call you wish to make: URGENCY or SAFETY.
3. Press SEND to transmit the call. The call is transmitted on channel 70, and then the radio tunes to channel 16 at high power.
4. Press OK to reconfirm the All Ships Call. The radio returns to standby mode. Press **PTT** to communicate on channel 16.

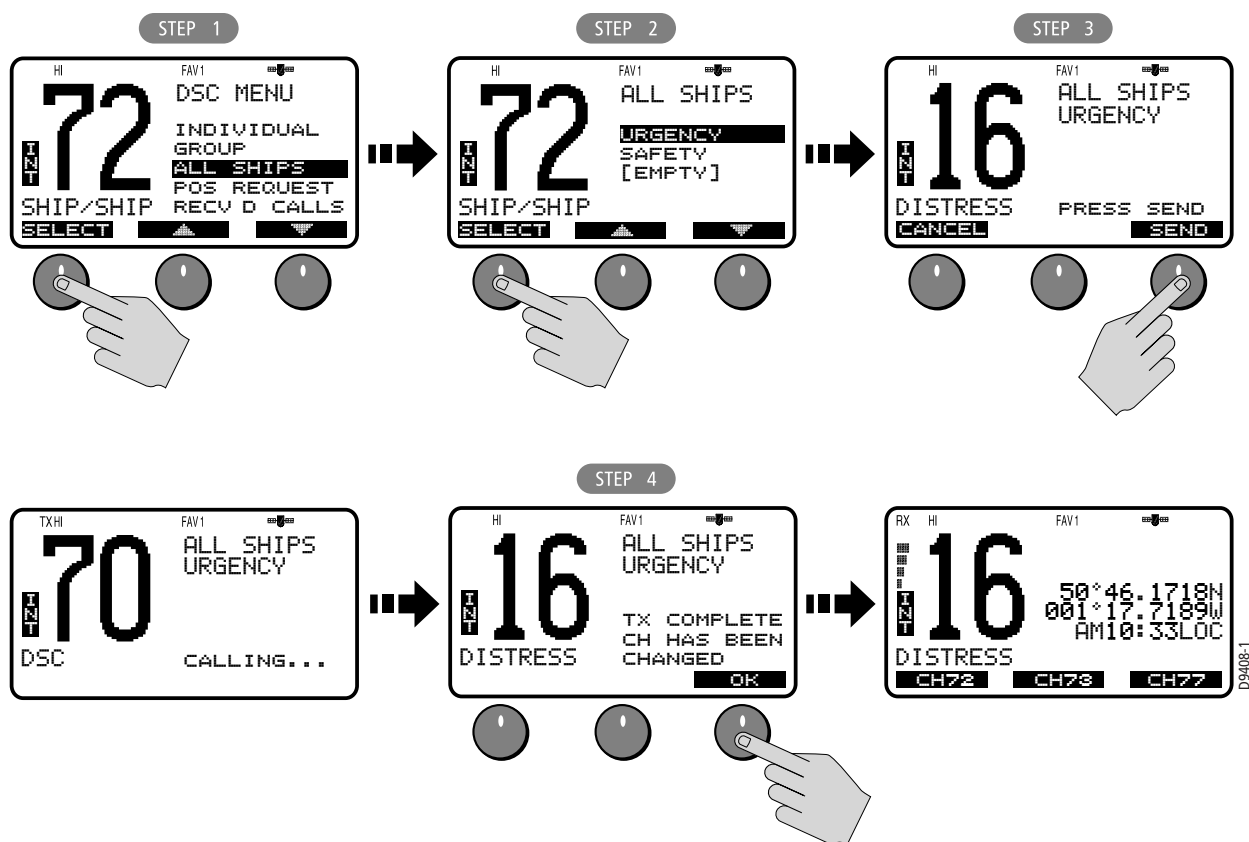

Receiving an All Ships Call

When an All Ships Safety or Routine Call is received, the LCD alternates between a screen displaying the name (or MMSI ID) of the station initiating the call and one requesting a change of working channels. The 2 alternating pages of data are recorded in the Call Log. The envelope icon (✉) blinks until you accept the call, reject the call, or open the resulting unread message stored in the log. See page "Received Calls (Logs)" on page 94.

For an Urgency or Distress Call, the Automatic Channel Change option (see page 98) determines how the call is handled. If set ON, the radio automatically switches to Priority Channel 16 for voice communications. If OFF, you are prompted to manually accept or decline the call and channel change by pressing OK or CANCEL, respectively. When set OFF, the  icon appears.

To mute the alert tone:

Press **CLEAR**. Automatic cancellation takes place after 2 minutes.

To ignore the All Ships Call:

Press **CLEAR** a second time or press the CANCEL soft key. The envelope icon disappears, the call is interrupted and the normal screen appears on the LCD.

To accept an All Ships Safety or Routine Call:

1. Press the OK soft key or the **CH/OK** knob. The alert tone is muted, the envelope icon disappears and the radio switches to the requested channel.
2. Press OK again to confirm the channel change. The radio returns to standby mode. Press **PTT** to communicate on channel 16.

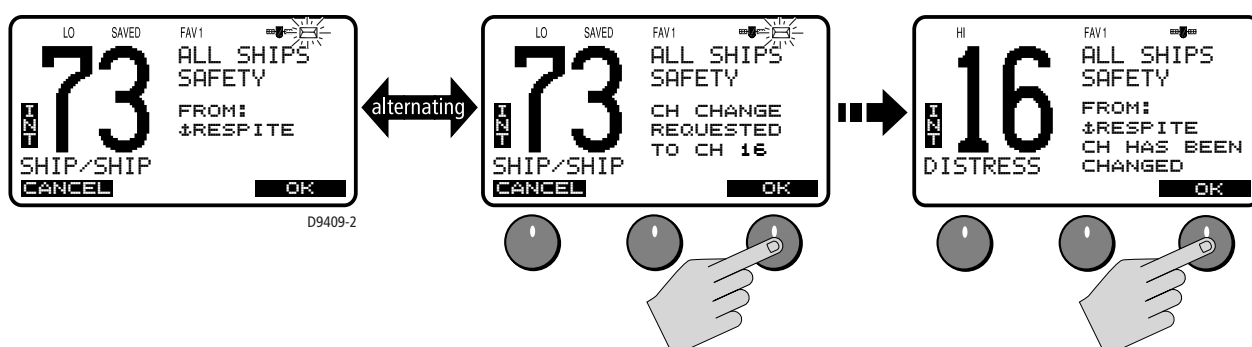

To accept an All Ships Urgency or Distress Call when Auto Channel Change is OFF

1. Press the OK soft key or the **CH/OK** knob. The alert tone is muted, the envelope icon disappears and the radio switches to channel 16.
2. Press OK again to confirm the channel change. The radio returns to standby mode. Press **PTT** to communicate on channel 16.

To accept an All Ships Urgency or Distress Call when Auto Channel Change is ON

Press the OK soft key or the **CH/OK** knob. The alert tone is muted, the envelope icon disappears and the radio automatically switches to channel 16. Press **PTT** to communicate.

If the caller requests that you change to an unsupported working channel the message INVALID CHANNEL appears on the LCD. If an acknowledgement is sent, the originating station is sent the message UNABLE TO COMPLY, indicating that your radio could not make the requested channel change.

...with Auto Channel Change OFF

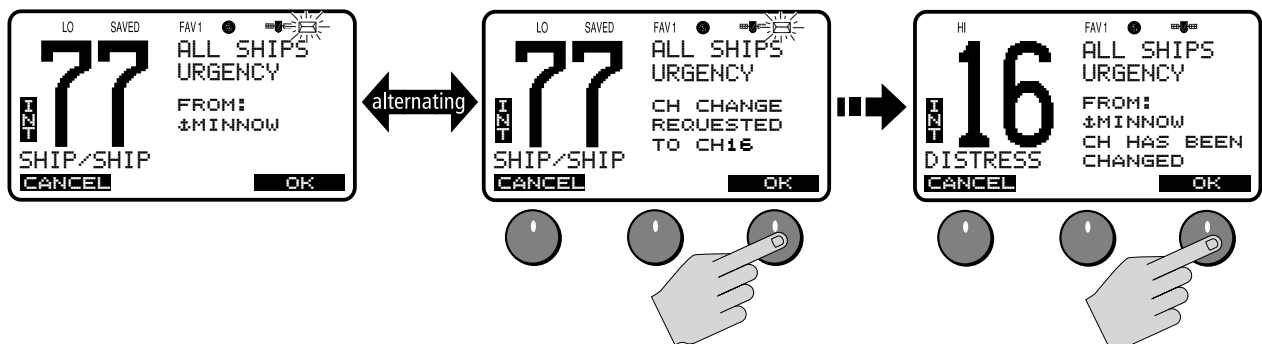

...with Auto Channel Change ON

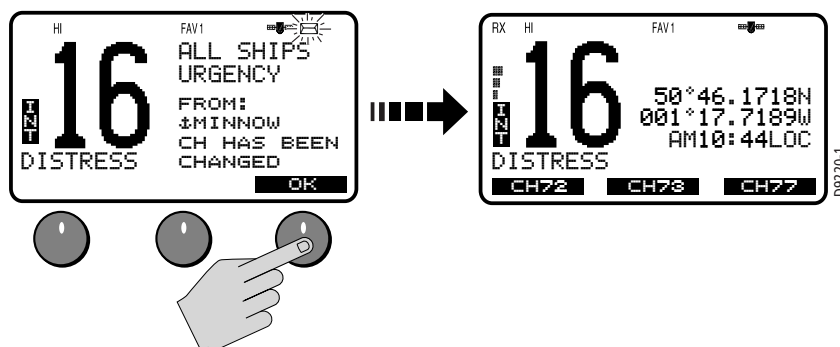

5.7 Position Request

With this option you can request GPS position information from any station capable of responding to this type of call and for which an MMSI number is known. You can specify the target station either by selecting it from your MMSI phonebook or by manually entering its MMSI number.

Your radio has the capability of forwarding position data from a responding vessel to your display unit (C Series, E Series, etc.) over the NMEA port so that it can be displayed on the screen. You can specify which stations will have their position data information sent to the display unit using the option NMEA Output, which is described on page 61.

Specifying the Target Vessel

1. Select POS REQUEST from the DSC Menu.
2. Select the target station name from the phonebook.
—or—
Select <MANUAL> and enter the target station's MMSI number, as described in "Adding a new Entry" on page 79.
3. Press SEND to transmit the Position Request Call.
The call is transmitted on channel 70, and then the radio tunes to the original channel and waits for acknowledgement. During this period you are still able to receive calls.

Note: To conform with regulations of the Basel Agreement for radiotelephone service on inland waterways, DSC functions are disabled when ATIS is active. See "ATIS Function" on page 65.

When the Position Request is accepted by the receiving station:

When the position request is received, the Ray218E/Ray55E shows that the call has been accepted by the requested station. The radio sounds a Call Alert tone. Press any key to mute the alert tone. It shuts off automatically after two minutes.

Press **CLEAR** to exit to normal radio operation. You can retrieve the position information later using DSC MENU > RECV'D CALLS > POSIT'N LOG.

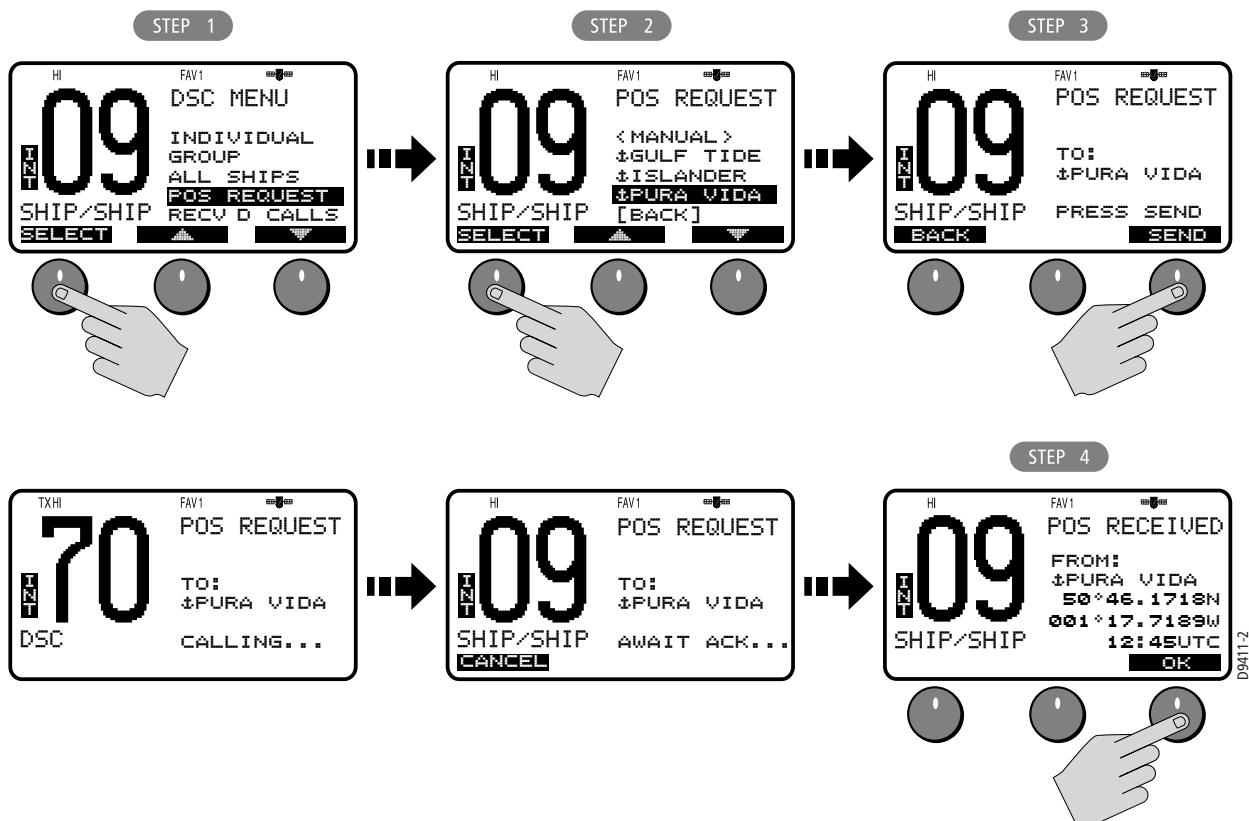

Retrieving the Last Received Position Data

1. From the DSC Menu, select RECV'D CALLS.
2. Rotate the **CH/OK** knob or press the up down arrow keys to select POSIT'N LOG.
3. Push in the **CH/OK** knob or press SELECT. The last received position request data (LAST CALL) is displayed.

Note: Only the last position is saved. The next received position will overwrite the existing position data.

Press BACK or the **CLEAR** key to exit.

Receiving a Position Request From Another Station

If you receive a position request from another station, how the Ray218E/Ray55E responds depends on the option you have set in the Position Reply menu item (see page 99). OFF will not send position data under any circumstances. AUTO sends out your vessel's position data as soon as it is requested. MANUAL sends out the data only after you respond to the request.

The 2 alternating pages of data are recorded in the Posit'n Log. The envelope icon (✉) blinks until you accept the call, reject the call, or open the resulting unread message stored in the Log. See page "Received Calls (Logs)" on page 94.

When a Manual Position Reply is received, the requesting station's MMSI number or station name (if entered in the Phonebook) is displayed. Press ACCEPT to accept the request to send your position data. Decline the request by pressing CANCEL or the **CLEAR** key.

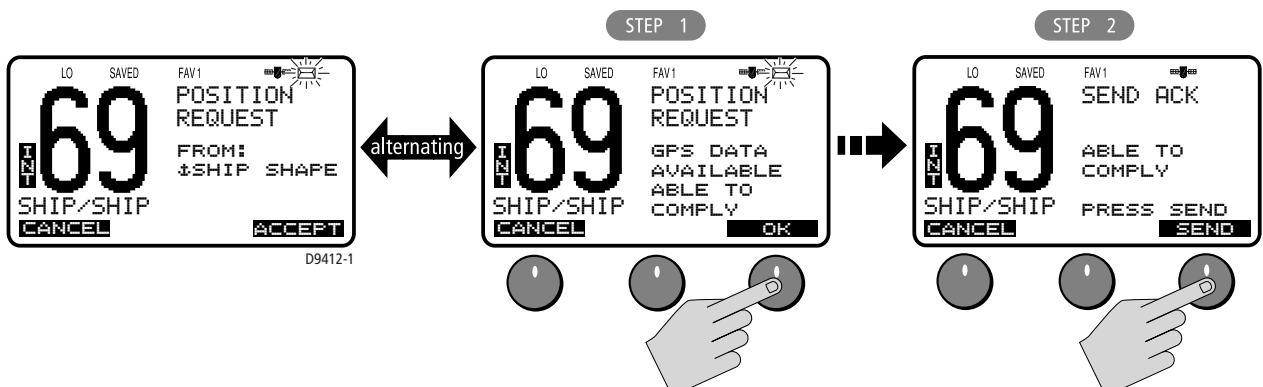

5.8 Received Calls (Logs)

The radio maintains lists of the last received DSC call types by number and time of call. Separate logs are maintained for the following:

1. Distress (up to 10 entries, per log)
 - Distress Log
 - Distress ACK Log
 - Distress Relay Log
2. Call Log (up to 40 total entries)
 - Individual Calls
 - All Ship Calls
 - Group Calls
3. Position Log
 - Last call received

If the calling vessel or station is listed in your DSC Phonebook, the vessel or station name appears in the display as it is listed. If the caller is not listed in your directory, the caller's MMSI ID number appears in the display.



When a DSC Call is received, the envelope icon blinks on the LCD and an arrow symbol (➔) appears to the left of the appropriate log. The envelope icon and arrow symbol disappear when the log is opened.

Coast Stations are identified by MMSI ID numbers beginning with "00". If you have assigned a name for a Coast Station in the phonebook, a tower symbol (⚓) precedes the name field in the log to identify it as such. Similarly, Group Stations have a single "0" in the initial MMSI number position and are labeled with a plus symbol (⊕) in the initial position of the name field in the phonebook or log. If the the MMSI ID begins with any number other than "0", an anchor symbol (⚓) is entered as a prefix to the name, identifying this as a Ship Station.

Station Type	MMSI ID Layout	Phonebook/ Log Symbol
Ship	xxxxxxxx	⚓
Group	0xxxxxxxx	⊕
Coast	00xxxxxxxx	⚓

To view the Received Call Logs:

1. Highlight RECV'D CALLS from the DSC menu.
2. Press SELECT. Three log categories appear: DISTRESS, CALL LOG and POSIT'N LOG. If any of these logs contain an unread item, an arrow symbol (▶) appears to the left of the log name.
3. Highlight the desired log.
4. Press Select. Entry 01 appears first with call type and time of the last call. This is the most recent call.
5. Using the **CH/OK** knob or up/down arrow soft keys, scroll down the list of up to 40 entries.

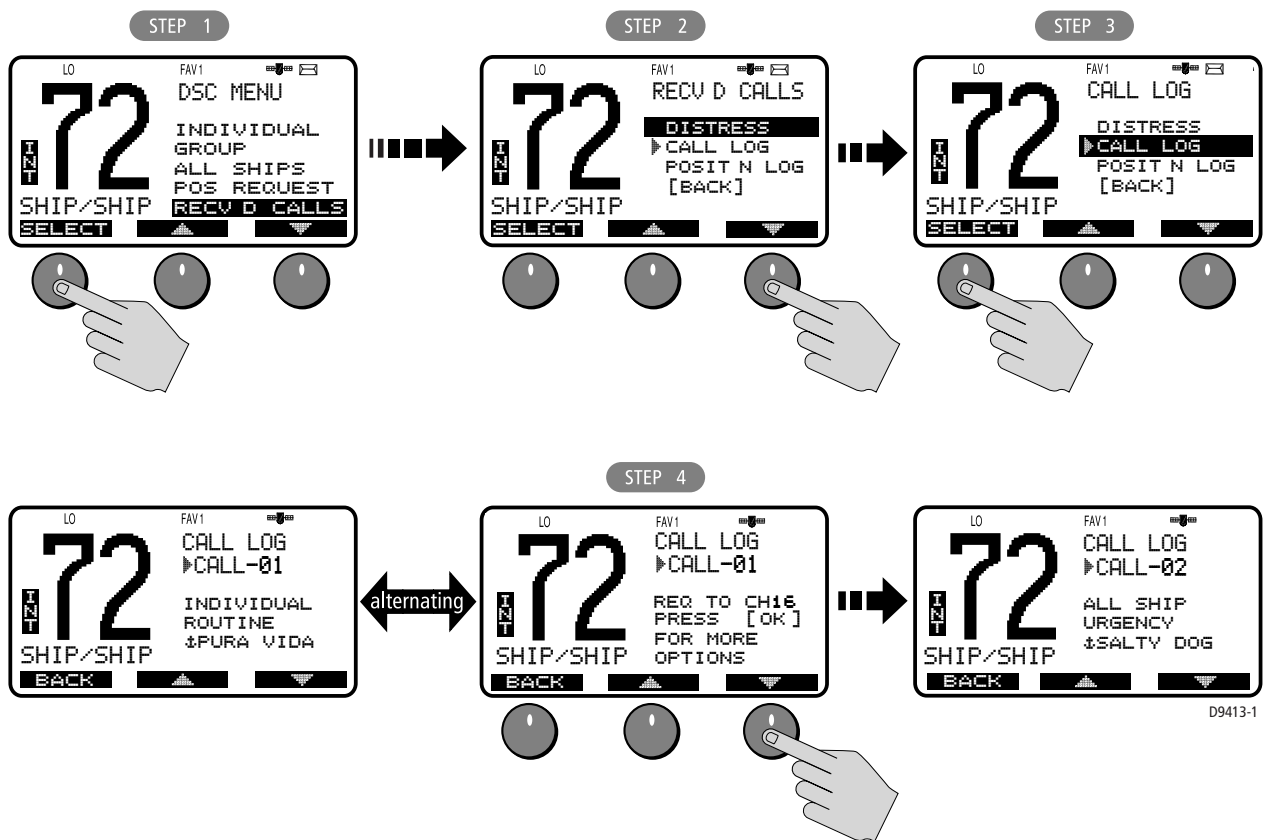

If the caller had requested a change to an unsupported working channel, Unable to Comply appears, indicating the radio could not comply with the channel change request.

Log Entry Options

The DSC Call Logs provide additional options for each entry. When the prompt appears PRESS [OK] FOR MORE OPTIONS, press the **CH/OK** knob. Select from the following:

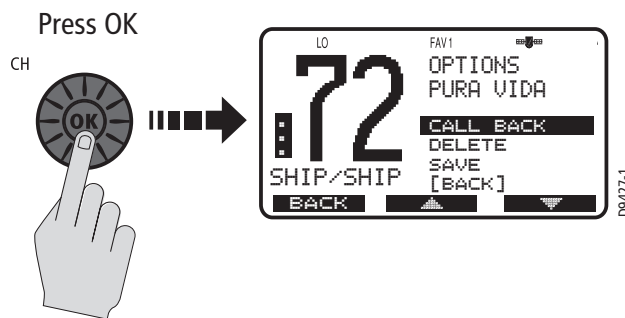

- Call Back. Makes a routine Individual Call to the caller listed in the entry.
- Delete. Remove this entry from the log.
- Save. Stores any undefined MMSI number into the Phonebook and enables you to assign a corresponding name to it. If a name is already assigned for this MMSI number in the phonebook, you are prompted to edit the name.

5.9 DSC Setup

The DSC Setup menu item is used to determine the following functions:

- the radio's MMSI ID number
- how your radio responds to a Position Reply request
- whether your radio automatically changes channels for incoming Distress and All Ships Urgency Calls

To adjust the DSC settings:

1. Press and hold the **MENU/DSC** key for 3 seconds to enter DSC Menu mode.
2. Rotate the **CH/OK** knob or press the up down arrow keys to highlight DSC SETUP.
3. Push the **CH/OK** knob or press SELECT to accept. The DSC Setup screen appears.

Make your selection from the following options:

- MY MMSI ID
- AUTO CH CHG
- POS REPLY

My MMSI ID

This operation stores the MMSI number required for DSC communications, including Distress Calls. If you try to access a DSC function before entering the MMSI number, an error message appears and you are prompted to enter the MMSI ID.

Note: *You can request an MMSI number from the same agency that issues radio or Ship Radio licences in your area. If regulations in your area do not permit you to program the MMSI number yourself, your Raymarine dealer/distributor can program the number for you.*

This is a one time operation. After the MMSI number is programmed:

- you will not be able to change it
- only your dealer/distributor can change it
- after entering your MMSI ID, accessing this menu item will merely display the programmed number

To enter or view the MMSI ID number:

1. From the DSC Menu, select DSC SETUP.
2. From the DSC SETUP menu item, select MY MMSI ID.
If an existing MMSI ID is stored, the value appears. If the MMSI ID is blank, dashes appear, indicating that one has yet to be entered. The first character space to be modified is highlighted with a flashing underline.
3. Rotate the **CH/OK** knob. The flashing underline is replaced with a numeric character. Continue rotating the knob to scroll through the selections. Use the < and > soft keys to edit selected characters, if necessary.
4. When the appropriate number appears, press the **CH/OK** knob to accept. The next character to be filled in sequence is then underlined. Continue this process until all MMSI characters have been entered.
5. When all digits have been selected, press DONE to accept.
You are prompted to re-enter the MMSI number.
6. Using the **CH/OK** knob, re-enter all nine MMSI digits to confirm.
7. Press the **CH/OK** knob to accept your selections.
If the second entry does not match the first entry, a warning message is displayed and you are prompted to press BACK, and then retry.
8. When complete, press DONE to accept. The PROGRAMMING SUCCESSFUL screen appears.
9. Press DONE one last time to save the MMSI ID number and return to the DSC SETUP screen.

Note:

- *The Ray218E/Ray55E is designed to be used as a recreational Ship Station only.*
- *You cannot begin the MMSI ID number with "0" (single zero), as this prefix indicates a GROUP ID.*
- *You cannot begin the MMSI ID number with "00" (double zero), as this prefix indicates a COAST STATION.*

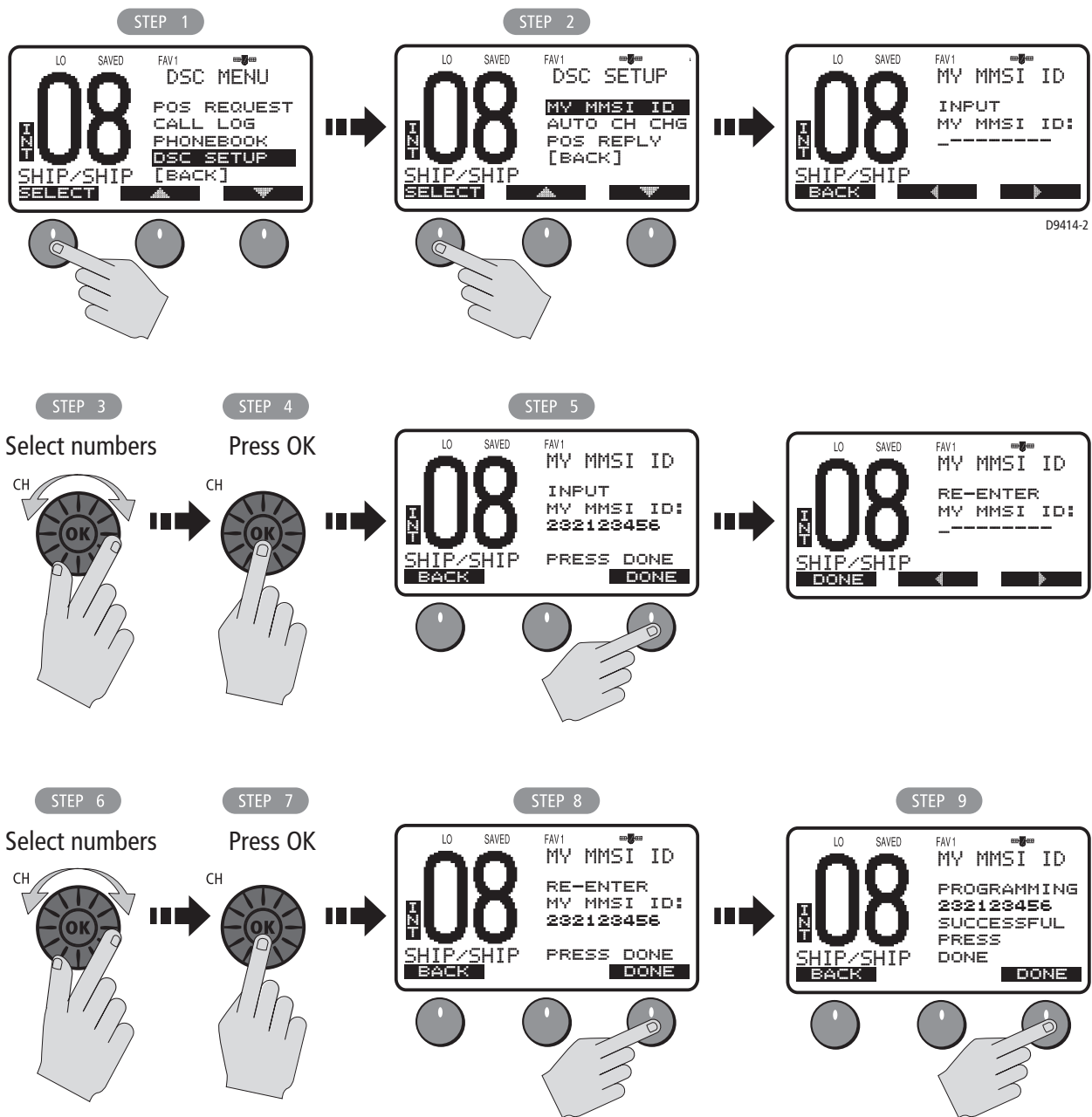

Automatic Channel Changing for Incoming Calls

For incoming Distress and All Ships Urgency Calls, this option determines whether your radio automatically switches to Priority Channel 16 to receive the call or prompts you to manually accept or decline the channel change.

The default setting is to ENABLE the auto channel change. If set OFF, the  icon appears on the LCD.

This feature is useful for preventing your radio from automatically switching channels while you are maintaining a continuous watch on a certain channel (for example, in a VTS controlled area) or working with other vessels (for example, for towage).

Note: *This feature can disable automatic channel switching for incoming DSC Distress and All Ships Urgency Calls. If enabled, you are responsible for determining whether manually declining the call is appropriate.*

To enable/disable automatic channel change:

1. From the DSC SETUP menu item, highlight AUTO CH CHG.
2. Press SELECT to accept.
3. Select either ON or OFF.
4. Press SELECT to accept.

If you accept ON (the default), your Ray218E/Ray55E automatically changes to channel 16 when a Distress or All Ships Urgency Call is received.

If you accept OFF, on receipt of a Distress or All Ships Urgency Call you are presented with brief details of the call and advised that a change to channel 16 has been requested. You can either accept the channel change or decline, thereby continuing to monitor your current channel. When set OFF, the  icon appears on the LCD.

If you accept the request, the call is received, a tone sounds and the radio is changed to channel 16. Pressing any key disables the alarm. If you ignore the call, after 5 minutes the radio declines the call, records the call in the Call Log and maintains normal operation.

Position Reply

This option enables you to determine how your radio responds to a request for your GPS position information (lat/lon) from another station.

To enable/disable Position Reply:

1. From the DSC SETUP menu, highlight POS REPLY.
2. Press SELECT to accept.
3. Highlight the desired setting and press SELECT to accept.
 - AUTO sends out your vessel's position data as soon as it is requested.
 - MANUAL sends out the data only after you respond to the request.
 - OFF will not send position data under any circumstances, nor notify you that the request has been made.

The default setting is MANUAL, which is described in "Position Request" on page 91.

Chapter 6: Customer Service

This chapter provides information on service for your Ray218E or Ray55E.

6.1 How to Contact Raymarine

On the Internet

Visit the Raymarine World Wide Web site for the latest information on Raymarine electronic equipment and systems at:

www.raymarine.com

Customer Support

Navigate to the Customer Support page for links for:

- Finding Factory Service locations and Authorized Dealers near you
- Registering your Raymarine products
- Accessing handbooks in Adobe Acrobat format
- Downloading RayTech software updates
- Accessing the Raymarine solution database

Clicking the Find Answers link routes you to our solution database. Search questions and answers by product, category, keywords, or phrases. If the answer you are seeking is not available, click the Ask Raymarine tab to submit your own question to our technical support staff, who will reply to you by e-mail.

Product Repair and Service

In the unlikely event your Raymarine unit should develop a problem, please contact your authorized Raymarine dealer/distributor for assistance. The dealer is best equipped to handle your service requirements and can offer timesaving help in getting the equipment back into normal operation.

Accessories and Parts

Raymarine accessory items and parts are available through your authorized Raymarine distributor. Please refer to the lists of component part numbers and optional accessories in the Installation chapter of this manual and have the Raymarine part number ready when speaking with your dealer.

If you are uncertain about what item to choose for your unit, please contact our Customer Services Department prior to placing your order.

Worldwide Support

Please contact the authorized distributor in the country.

Appendix A: Specifications

General

Mounting	Bracket or flush mount
Size (H x W x D): Ray218E Flush Mounted Bracket Mounted	97.5 x 198 x 179.3 mm (3.84 x 7.79 x 7.06 in) 112.5 x 222.5 x 179.3 mm (4.43 x 8.76 x 7.06 in)
Size (H x W x D): Ray55E Flush Mounted Bracket Mounted	80 x 180 x 174 mm (3.15 x 7.09 x 6.85 in) 93.8 x 191 x 174 mm (3.69 x 7.52 x 6.85 in)
Weight, Ray218E: Transceiver Microphone	1.59 kg (3.5 lbs) 0.181 kg (0.4 lbs)
Weight, Ray55E: Transceiver & Microphone	1.59 kg (3.5 lbs)
Weight, Raymic	0.227 kg (0.5 lbs)
Power	12 VDC system (13.6 VDC, typical)
Environmental: Operating Range Storage Range Humidity	Waterproof to IPX7 -10°C to +50°C -20°C to +70°C up to 95%
Frequency Range: Transmit: Receive	155.500 to 162.425 MHz (including private CH) 155.500 to 162.425 MHz (including private CH)
Oscillate Mode	PLL
Modulation	FM (16K0G3E) DSC (16K0G2B)
Channel Spacing	25 kHz Increments
Frequency Stability	+/- 10 PPM (+/- 0.001%)
Audio Output Power	5 watts, typical (at 10% distortion with 4 ohms load)
Hailer Output Power:	30 watts @ 4 ohms (Ray218E only)
Antenna Port Impedance	50 ohms, typical
NMEA Port Impedance	100 ohms
External Speaker Impedance	4 ohms
Hailer Horn Impedance	4 ohms

NMEA IN Sentences supported (NMEA 0183 ver. 3.01):	GLL GGA RMA RMC GNS	Geographic position, Latitude/Longitude GPS fix data Recommended minimum data for LORAN Recommended minimum data for GPS GNSS fix data
NMEA OUT Sentences (NMEA 0183 ver. 3.01):	DSC DSE	DSC data Extended DSC data

Transmitter

Frequency Error	10 ppm
RF Power (at 13.6 VDC):	
Hi Mode	25 W
Lo Mode	1 W
Maximum Deviation	± 5 KHz
FM Hum and Noise Level	less than -40 dB below audio level
Adjacent Channel Power	more than 70 dB
Spurious/Harmonic Emissions	less than -70 dBc
Current Drain:	
Hi Power at 13.6V DC	less than 6 A

Receiver

Sensitivity @ 12db SINAD	0.28 μ V, typical
Hum and Noise	less than -40 dB below audio level
Audio Distortion	less than 10%
Adjacent Channel Rejection	more than 80 dB, typical
Intermodulation Rejection Ratio	more than 80 dB, typical
Spurious Image Rejection	more than 80 dB, typical
Squelch Sensitivity @ 12db SINAD	
at tight	less than 1 μ V,
at threshold	less than 0.28 μ V

Appendix B: Radio Controls

This section is a quick reference to your radio's controls.

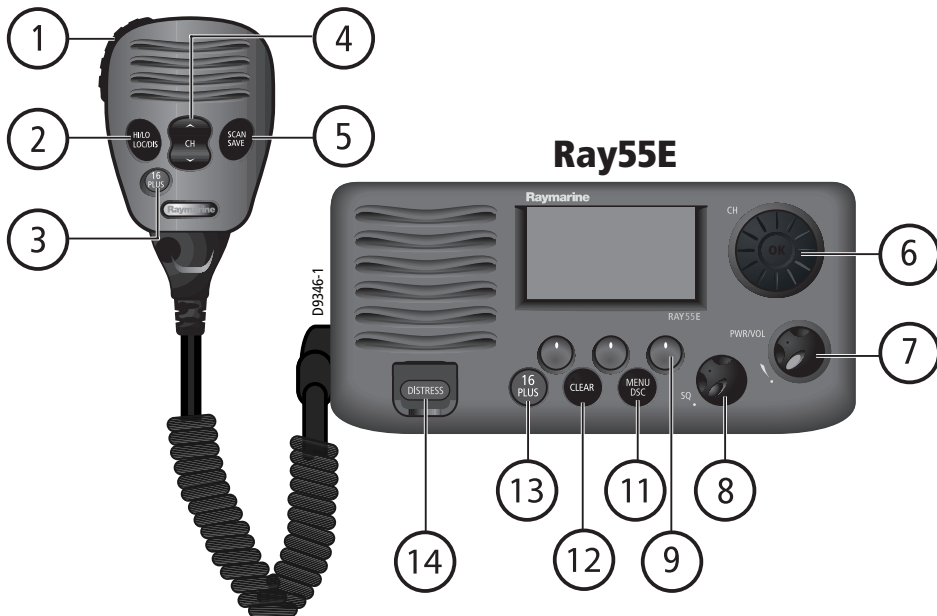
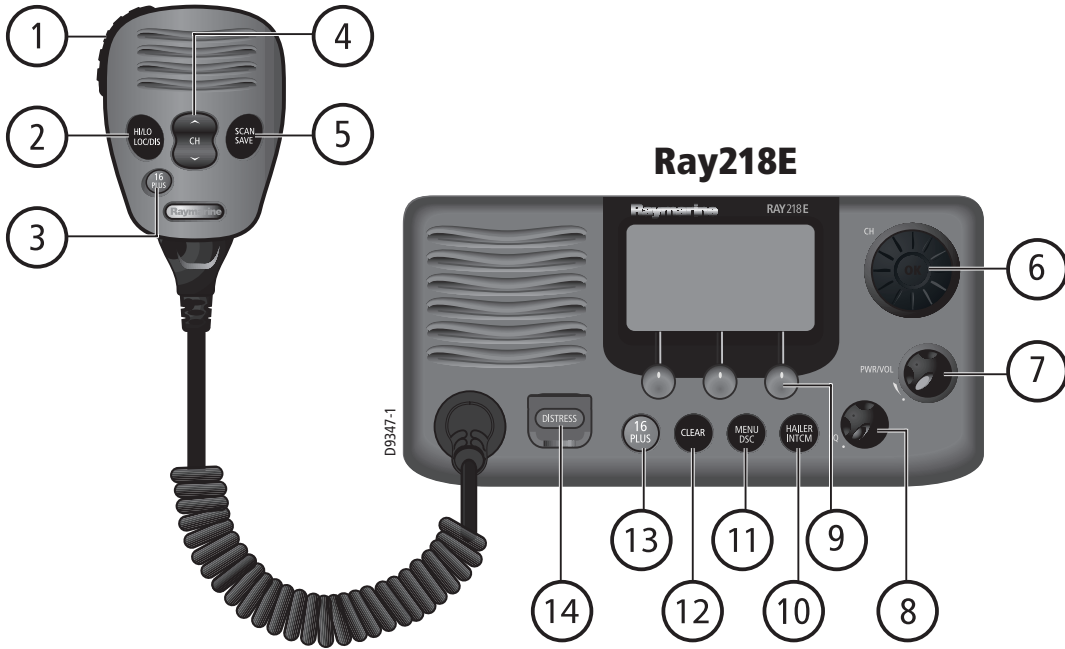

Microphone Keys

Key Name	Press & Release	Press & Hold 3 seconds
1. PTT	Push-to-Talk	Push-to-Talk
2. HI/LO LOC/DIS	TX Power High/Low and ACCEPT key for menu item selections	Toggles between full receiver sensi- tivity (Distant mode) and attenuated receiver sensitivity (Local mode).
3. 16/PLUS	Switch between the Priority and Working Channels	Switches to Secondary Priority (PLUS) channel; If already tuned to the PLUS channel, programs a new PLUS channel.
4. UP/DOWN	Channel changing and navigating menu item selections	Rapid channel change and navigat- ing menu item selections
5. SCAN/ SAVE	Initiate Priority Saved Scan mode or terminate any active scan.	SAVE/DELETE channel to/from memory

Transceiver Controls

Key Name	Function
6. CH/OK	Rotate to change channels or navigate menu items. Press to accept menu item selections.
7. PWR/VOL	Power radio ON / OFF and adjust volume level
8. SQ	Adjust squelch threshold level
9. Soft Keys	Press appropriate key to make associated menu selections

Transceiver Push Keys

Key Name	Press & Release	Press & Hold 3 seconds
10. HAILER/INTCM (Ray218E only)	Activate Hailer functions	Activate Intercom functions
11. MENU/DSC	Activate Menu functions	Activate DSC functions
12. CLEAR	Cancel function	Weather Channel Mode, if so pro- grammed

Key Name	Press & Release	Press & Hold 3 seconds
13. 16/PLUS	Switch between the Priority and Working Channels	Switches to Secondary Priority (PLUS) channel; If already tuned to the PLUS channel, programs new PLUS channel.
14. DISTRESS	Designate Distress Type	Make Distress Call

Optional Raymic Handset

The optional Raymic provides you with more functions than the standard microphone in a telephone handset design.

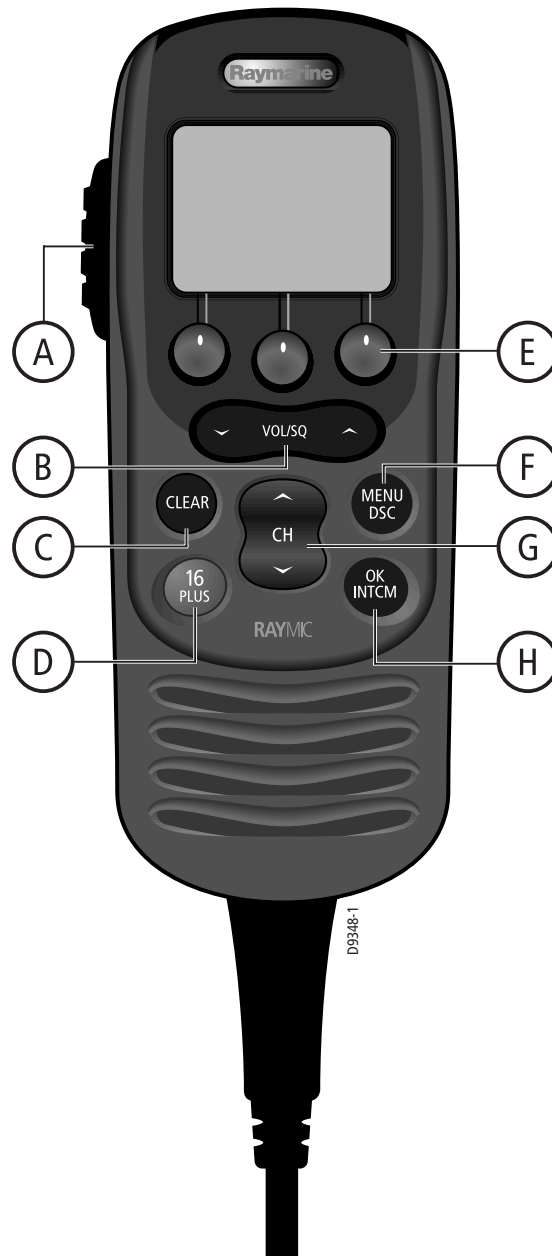

Raymic Keys

Key Name	Function
A. PTT	Push-to-Talk.
B. VOL/SQ	By default, these keys control earpiece speaker volume. Press the up arrow key to increase or the down arrow to decrease the volume. Press and release the VOL/SQ key to activate squelch threshold level adjustment. Press the down arrow key until audio is heard. Then press the up arrow until background noise disappears.
C. CLEAR	Press and release to invoke Cancel function. Press and hold 3 seconds to access Weather Channel Mode, if so programmed.
D. 16/PLUS	Press and release to switch between the Priority and Working CH. Press and hold 3 seconds to switch to Secondary Priority (PLUS) CH; If already tuned to the PLUS channel, programs a new PLUS channel.
E. Soft Keys	Press appropriate key to make associated menu selections.
F. MENU/DSC	Press and release to activate Menu functions. Press and hold 3 seconds to activate DSC functions.
G. CH UP/DOWN	Channel changing and navigating through menu item options.
H. OK/INTCM	Press and release to accept menu item selections. Press and hold 3 seconds to activate Intercom functions.

Appendix C: Menu Structure

Following is the structure of the menu that appears when the **MENU/DSC** key is pressed and then immediately released.

MENU

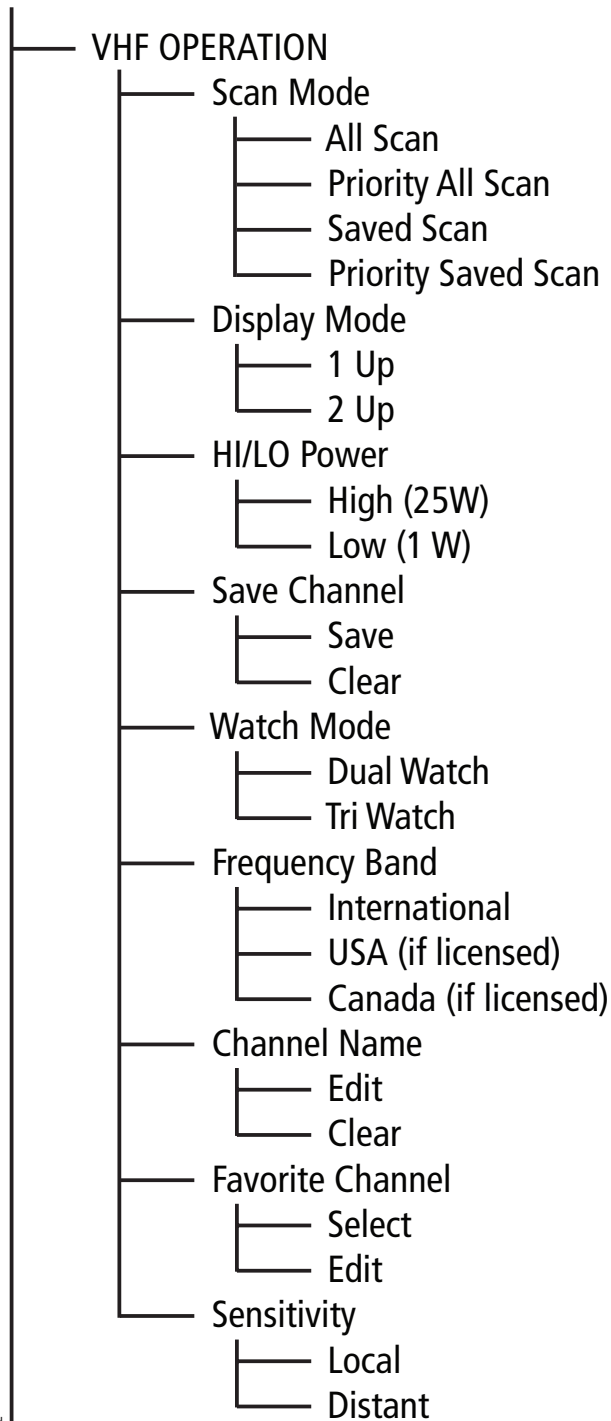

D9415-2

(continued in next column)

MENU (continued)

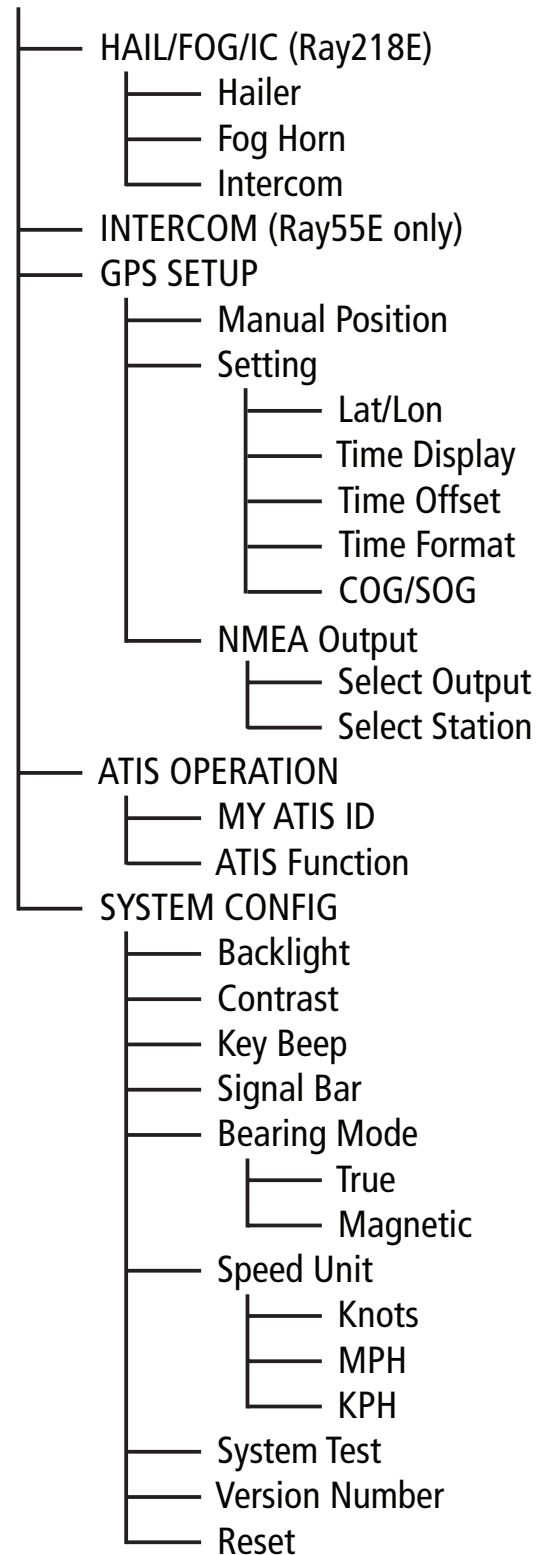

Following is the structure of the menu that appears when the **MENU/DSC** key is pressed and held for 3 seconds.

DSC

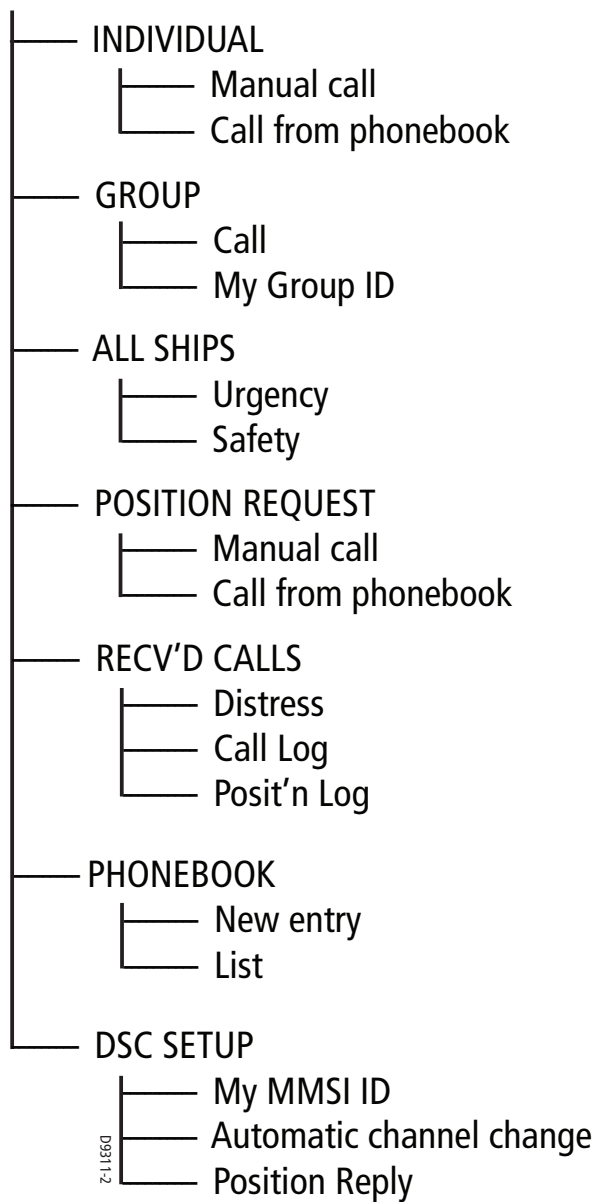

Appendix D: Channel List

International Marine VHF Channels & Frequencies

CH No.	XMIT Freq	RCV Freq	Single Freq	Use
01	156.050	160.650		Public Correspondence, Port Operations and Ship Movement
02	156.100	160.700		Public Correspondence, Port Operations and Ship Movement
03	156.150	160.750		Public Correspondence, Port Operations and Ship Movement
04	156.200	160.800		Public Correspondence, Port Operations and Ship Movement
05	156.250	160.850		Public Correspondence, Port Operations and Ship Movement
06	156.300	156.300	x	Intership ¹
07	156.350	160.950		Public Correspondence, Port Operations and Ship Movement
08	156.400	156.400	x	Intership
09	156.450	156.450	x	Intership, Port Operations and Ship Movement
10	156.500	156.500	x	Intership, Port Operations and Ship Movement ²
11	156.550	156.550	x	Port Operations and Ship Movement
12	156.600	156.600	x	Port Operations and Ship Movement
13	156.650	156.650	x	Intership Safety, Port Operations and Ship Movement ³
14	156.700	156.700	x	Port Operations and Ship Movement
15	156.750	156.750	x	Intership and On-board Communications at 1W only ⁴
16	156.800	156.800	x	Distress, Safety and Calling
17	156.850	156.850	x	Intership and On-board Communications at 1W only ⁴
18	156.900	161.500		Public Correspondence, Port Operations and Ship Movement
19	156.950	161.550		Public Correspondence, Port Operations and Ship Movement
20	157.000	161.600		Public Correspondence, Port Operations and Ship Movement
21	157.050	161.650		Public Correspondence, Port Operations and Ship Movement
22	157.100	161.700		Public Correspondence, Port Operations and Ship Movement

CH No.	XMIT Freq	RCV Freq	Single Freq	Use
23	157.150	161.750		Public Correspondence, Port Operations and Ship Movement
24	157.200	161.800		Public Correspondence, Port Operations and Ship Movement
25	157.250	161.850		Public Correspondence, Port Operations and Ship Movement
26	157.300	161.900		Public Correspondence, Port Operations and Ship Movement
27	157.350	161.950		Public Correspondence, Port Operations and Ship Movement
28	157.400	162.000		Public Correspondence, Port Operations and Ship Movement
60	156.025	160.625		Public Correspondence, Port Operations and Ship Movement
61	156.075	160.675		Public Correspondence, Port Operations and Ship Movement
62	156.125	160.725		Public Correspondence, Port Operations and Ship Movement
63	156.175	160.775		Public Correspondence, Port Operations and Ship Movement
64	156.225	160.825		Public Correspondence, Port Operations and Ship Movement
65	156.275	160.875		Public Correspondence, Port Operations and Ship Movement
66	156.325	160.925		Public Correspondence, Port Operations and Ship Movement
67	156.375	156.375	x	Intership, Port Operations and Ship Movement ²
68	156.425	156.425	x	Port Operations and Ship Movement
69	156.475	156.475	x	Intership, Port Operations and Ship Movement
71	156.575	156.575	x	Port Operations and Ship Movement
72	156.625	156.625	x	Intership
73	156.675	156.675	x	Intership ²
74	156.725	156.725	x	Port operations and Ship movement
75	156.775	156.775	x	See Note 5
76	156.825	156.825	x	See Note 5
77	156.875	156.875	x	Intership
78	156.925	161.525		Public correspondence, Port Operations and Ship Movement
79	156.975	161.575		Public correspondence, Port Operations and Ship Movement

CH No.	XMIT Freq	RCV Freq	Single Freq	Use
80	157.025	161.625		Public correspondence, Port Operations and Ship Movement
81	157.075	161.675		Public correspondence, Port Operations and Ship Movement
82	157.125	161.725		Public correspondence, Port Operations and Ship Movement
83	157.175	161.775		Public correspondence, Port Operations and Ship Movement
84	157.225	161.825		Public correspondence, Port Operations and Ship Movement
85	157.275	161.875		Public correspondence, Port Operations and Ship Movement
86	157.325	161.925		Public correspondence, Port Operations and Ship Movement
87	157.375	157.375	x	Port Operations and Ship Movement
88	157.425	157.425	x	Port Operations and Ship Movement

- Intership channels are for communications between ship stations. Intership communications should be restricted to Channels 6, 8, 72 and 77. If these are not available, the other channels marked for Intership may be used.
- Channel 70 is used exclusively for Digital Selective Calling (DSC) and is not available for regular voice communications.

Notes:

1. Channel 06 may also be used for communications between ship stations and aircraft engaged in coordinated search and rescue operations. Ship stations should avoid harmful interference to such communications on channel 06 as well as to communications between aircraft stations, ice breakers and assisted ships during ice seasons.
2. Within the European Maritime Area and in Canada, channels 10, 67 and 73 may also be used by the individual administrations concerned for communication between ship stations, aircraft stations and participating land stations engaged in coordinated search and rescue and anti-pollution operations in local areas. Channels 10 or 73 (depending on location) are also used for the broadcast of Marine Safety Information by the Maritime and Coast Guard Agency in the UK only.
3. Channel 13 is designated for use on a worldwide basis as a navigation safety communication channel, primarily for intership navigation safety communications.
4. Channels 15 and 17 may also be used for on-board communications provided the effective radiated power does not exceed 1 Watt.
5. The use of Channels 75 and 76 should be restricted to navigation related communication only and all precautions should be taken to avoid harmful interference to channel 16. Transmit power is limited to 1 Watt.

U.S. Marine VHF Channels and Frequencies

CH. No	XMIT Freq	RCV Freq	Single Freq	Use
01A	156.050	156.050	x	Port Operations and Commercial, VTS. Available only in New Orleans / Lower Mississippi area. ¹
03A	156.150	156.150	x	U.S. Government only
05A	156.250	156.250	x	Port Operations or VTS in the Houston, New Orleans and Seattle areas.
06	156.300	156.300	x	Intership Safety
07A	156.350	156.350	x	Commercial
08	156.400	156.400	x	Commercial (Intership only)
09	156.450	156.450	x	Boater Calling. Commercial and Non-Commercial.
10	156.500	156.500	x	Commercial
11	156.550	156.550	x	Commercial. VTS in selected areas.
12	156.600	156.600	x	Port Operations. VTS in selected areas.
13	156.650	156.650	x	Intership Navigation Safety (Bridge-to-bridge). Ships >20meters in length maintain a listening watch on this channel in US waters. ^{2,6}
14	156.700	156.700	x	Port Operations. VTS in selected areas.
15	–	156.750	x	Environmental (Receive only). Used by Class 'C' EPIRBs. ³
16	156.800	156.800	x	International Distress, Safety and Calling. Ships required to carry radio, USCG, and most coast stations maintain a listening watch on this channel. ⁴
17	156.850	156.850	x	State Control ⁵
18A	156.900	156.900	x	Commercial
19A	156.950	156.950	x	Commercial
20	157.000	161.600		Port Operations (duplex)
20A	157.000	157.000	x	Port Operations
21A	157.050	157.050	x	U.S. Coast Guard only

CH. No	XMIT Freq	RCV Freq	Single Freq	Use
22A	157.100	157.100	x	Coast Guard Liaison and Maritime Safety Information Broadcasts. Broadcasts announced on channel 16.
23A	157.150	157.150	x	U.S. Coast Guard only
24	157.200	161.800		Public Correspondence (Marine Operator)
25	157.250	161.850		Public Correspondence (Marine Operator)
26	157.300	161.900		Public Correspondence (Marine Operator)
27	157.350	161.950		Public Correspondence (Marine Operator)
28	157.400	162.000		Public Correspondence (Marine Operator)
61A	156.075	156.075	x	U.S. Government only
63A	156.175	156.175	x	Port Operations and Commercial, VTS. Available only in New Orleans / Lower Mississippi area.
64A	156.225	156.225	x	U.S. Coast Guard only
65A	156.275	156.275	x	Port Operations
66A	156.325	156.325	x	Port Operations
67	156.375	156.375	x	Commercial. Used for Bridge-to-bridge communications in lower Mississippi River. Intership only. ⁶
68	156.425	156.425	x	Non-Commercial
69	156.475	156.475	x	Non-Commercial
71	156.575	156.575	x	Non-Commercial
72	156.625	156.625	x	Non-Commercial (Intership only)
73	156.675	156.675	x	Port Operations
74	156.725	156.725	x	Port Operations
77	156.875	156.875	x	Port Operations (Intership only) ⁵
78A	156.925	156.925	x	Non-Commercial
79A	156.975	156.975	x	Commercial. Non-Commercial in Great Lakes only.
80A	157.025	157.025	x	Commercial. Non-Commercial in Great Lakes only

CH. No	XMIT Freq	RCV Freq	Single Freq	Use
81A	157.075	157.075	x	U.S. Government only – Environmental protection operations.
82A	157.125	157.125	x	U.S. Government only
83A	157.175	157.175	x	U.S. Coast Guard only
84	157.225	161.825		Public Correspondence (Marine Operator)
85	157.275	161.875		Public Correspondence (Marine Operator)
86	157.325	161.925		Public Correspondence (Marine Operator)
87	157.375	161.975		Public Correspondence Marine Operator)
88	157.425	162.025		Public Correspondence only near Canadian border
88A	157.425	157.425	x	Commercial, Intership only

- Recreational boaters normally use channels listed as Non-Commercial: 68, 69, 71, 72, 78A.
- Channel 70 is used exclusively for Digital Selective Calling (DSC) and is not available for regular voice communications.
- Channels 75 and 76 are reserved as guard bands for Channel 16 and are not available for regular voice communications.

Notes:

1. The letter "A" following a channel number indicates simplex use of the ship station transmit side of an international semi-duplex channel. Operations are different from that of international operations on that channel.
2. Channel 13 should be used to contact a ship when there is danger of collision. All ships of length 20 meters or greater are required to guard VHF channel 13, in addition to VHF channel 16, when operating within U.S. territorial waters.
3. Channel is Receive Only.
4. Channel 16 is used for calling other stations or for distress alerting.
5. Output power is fixed at 1 watt only.
6. Output power is initially set to 1 watt. User can temporarily override this restriction to transmit at high power.

Canadian Marine VHF Channels and Frequencies

CH No.	XMIT Freq	RCV Freq	Area of Operation	Use
01	156.050	160.650	PC	Public Correspondence
02	156.100	160.700	PC	Public Correspondence
03	156.150	160.750	PC	Public Correspondence
04A	156.200	156.200	PC	Intership, Ship/Shore and Safety: Canadian Coast Guard search and rescue ¹
04A	156.200	156.200	EC	Intership, Ship/Shore and Commercial: Commercial fishing only
05A	156.250	156.250		Ship Movement
06	156.300	156.300	All areas	Intership, Commercial, Non-commercial and Safety: May be used for search and rescue communications between ships and aircraft.
07A	156.350	156.350	All areas	Intership, Ship/Shore, Commercial
08	156.400	156.400	WC, EC	Intership, Commercial and Safety: Also assigned for operations in the Lake Winnipeg area.
09	156.450	156.450	AC	Intership, Ship/Shore, Commercial, Non-commercial and Ship Movement: May be used to communicate with aircraft and helicopters in predominantly maritime support operations.
10	156.500	156.500	AC, GL	Intership, Ship/Shore, Commercial, Non-commercial, Safety and Ship Movement: May also be used for communications with aircraft engaged in coordinated search and rescue and antipollution operations.
11	156.550	156.550	PC, AC, GL	Intership, Ship/Shore, Commercial, Non-commercial and Ship Movement: Also used for pilotage purposes.
12	156.600	156.600	WC, AC, GL	Intership, Ship/Shore, Commercial, Non-commercial and Ship Movement: Port operations and pilot information and messages.
13	156.650	156.650	All areas	Intership, Commercial, Non-commercial and Ship Movement: Exclusively for bridge-to-bridge navigational traffic. Limited to 1-watt maximum power.

CH No.	XMIT Freq	RCV Freq	Area of Operation	Use
14	156.700	156.700	AC, GL	Intership, Ship/Shore, Commercial, Non-commercial and Ship Movement: Port operations and pilot information and messages.
15	156.750	156.750	All areas	Intership, Ship/Shore, Commercial, Non-commercial and Ship Movement: All operations limited to 1-watt maximum power. May also be used for on-board communications.
16	156.800	156.800	All areas	International Distress, Safety and Calling ²
17	156.850	156.850	All areas	Intership, Ship/Shore, Commercial, Non-commercial and Ship Movement: All operations limited to 1-watt maximum power. May also be used for on-board communications.
18A	156.900	156.900	All areas	Intership, Ship/Shore and Commercial: Towing on the Pacific Coast.
19A	156.950	156.950	All areas except PC	Intership and Ship/Shore: Canadian Coast Guard only.
19A	156.950	156.950	PC	Intership and Ship/Shore: Various Government departments.
20	157.000	161.600	All areas	Ship/Shore, Safety and Ship Movement: Port operations only with 1-watt maximum power.
21A	157.050	157.050	All areas	Intership and Ship/Shore: Canadian Coast Guard only.
21B	-	161.650	All areas	Safety: Continuous Marine Broadcast (CMB) service. ³
22A	157.100	157.100	All areas	Intership, Ship/Shore, Commercial and Non-commercial: For communications between Canadian Coast Guard and non-Canadian Coast Guard stations only.
23	157.150	161.750	PC	Ship/Shore and Public Correspondence: Also in the inland waters of British Columbia and the Yukon.
24	157.200	161.800	All areas	Ship/Shore and Public Correspondence
25	157.250	161.850	PC	Ship/Shore and Public Correspondence: Also assigned for operations in the Lake Winnipeg area.
25B	-	161.850	AC	Safety: Continuous Marine Broadcast (CMB) service.
26	157.300	161.900	All areas	Ship/Shore, Safety and Public Correspondence

CH No.	XMIT Freq	RCV Freq	Area of Operation	Use
27	157.350	161.950	AC, GL, PC	Ship/Shore and Public Correspondence
28	157.400	162.000	PC	Ship/Shore, Safety and Public Correspondence
28B	-	162.000	AC	Safety: Continuous Marine Broadcast (CMB) service.
60	156.025	160.625	PC	Ship/Shore and Public Correspondence
61A	156.075	156.075	PC	Intership and Ship/Shore: Canadian Coast Guard only.
61A	156.075	156.075	EC	Intership, Ship/Shore and Commercial: Commercial fishing only.
62A	156.125	156.125	PC	Intership and Ship/Shore: Canadian Coast Guard only.
62A	156.125	156.125	EC	Intership, Ship/Shore and Commercial: Commercial fishing only.
64	156.225	160.825	PC	Ship/Shore and Public Correspondence
64A	156.225	156.225	EC	Intership, Ship/Shore and Commercial: Commercial fishing only.
65A	156.275	156.275		Intership, Ship/Shore, Commercial, Non-commercial, Safety: Search & rescue and antipollution operations on the Great Lakes. Towing on the Pacific Coast. Port operations only in the St. Lawrence River areas with 1W maximum power. Pleasure craft in the inland waters of Alberta, Saskatchewan and Manitoba (excluding Lake Winnipeg and the Red River).
66A	156.325	156.325		Intership, Ship/Shore, Commercial, Non-commercial, Safety and Ship Movement: Port operations only in the St. Lawrence River/Great Lakes Areas with 1-watt maximum power.
67	156.375	156.375	EC	Intership, Ship/Shore and Commercial: Commercial fishing only.
67	156.375	156.375	All areas except EC	Intership, Ship/Shore, Commercial, Non-commercial, Safety: May also be used for communications with aircraft engaged in coordinated search and rescue and antipollution operations.

CH No.	XMIT Freq	RCV Freq	Area of Operation	Use
68	156.425	156.425	All areas	Intership, Ship/Shore and Non-commercial: For marinas and yacht clubs.
69	156.475	156.475	All areas except EC	Intership, Ship/Shore, Commercial and Non-commercial
69	156.475	156.475	EC	Intership, Ship/Shore and Commercial: Commercial fishing only.
71	156.575	156.575	PC	Intership, Ship/Shore, Commercial, Non-commercial, Safety and Ship Movement
71	156.575	156.575		Intership, Ship/Shore and Non-commercial: For marinas and yacht clubs on the East Coast and on Lake Winnipeg.
72	156.625	156.625	EC, PC	Intership, Commercial and Non-commercial: May be used to communicate with aircraft and helicopters in predominantly maritime support operations.
73	156.675	156.675	EC	Intership, Ship/Shore and Commercial: Commercial fishing only
73	156.675	156.675	All areas except EC	Intership, Ship/Shore, Commercial, Non-commercial, Safety: May also be used for communications with aircraft engaged in coordinated search and rescue and antipollu- tion operations.
74	156.725	156.725	EC, PC	Intership, Ship/Shore, Commercial, Non-commercial and Ship Movement.
77	156.875	156.875		Intership, Ship/Shore, Safety and Ship Movement: Pilotage on Pacific Coast. Port operations only in the St. Lawrence River/Great Lakes areas with 1W maximum power.
78A	156.925	156.925	EC, PC	Intership, Ship/Shore and Commercial
79A	156.975	156.975	EC, PC	Intership, Ship/Shore and Commercial
80A	157.025	157.025	EC, PC	Intership, Ship/Shore and Commercial
81A	157.075	157.075		Intership and Ship/Shore: Canadian Coast Guard use only in the St. Lawrence River/Great Lakes areas.
81A	157.075	157.075	PC	Intership, Ship/Shore and Safety: Canadian Coast Guard antipollution.

CH No.	XMIT Freq	RCV Freq	Area of Operation	Use
82A	157.125	157.125	PC	Intership, Ship/Shore and Safety: Canadian Coast Guard use only.
82A	157.125	157.125		Intership and Ship/Shore: Canadian Coast Guard use only in the St. Lawrence River/Great Lakes areas.
83	157.175	161.775	PC	Ship/Shore and Safety: Canadian Coast Guard use only.
83A	157.175	157.175	EC	Intership and Ship/Shore: Canadian Coast Guard and other Government agencies.
83B	-	161.775	AC, GL	Safety: Continuous Marine Broadcast (CMB) Service.
84	157.225	161.825	PC	Ship/Shore and Public Correspondence
85	157.275	161.875	AC, GL, NL	Ship/Shore and Public Correspondence
86	157.325	161.925	PC	Ship/Shore and Public Correspondence
87	157.375	161.975	AC, GL, NL	Ship/Shore and Public Correspondence
88	157.425	162.025	AC, GL, NL	Ship/Shore and Public Correspondence

Area of Operation

AC: Atlantic Coast, Gulf and St. Lawrence River up to and including Montreal

EC (East Coast): includes NL, AC, GL and Eastern Arctic areas

GL: Great Lakes (including St. Lawrence above Montreal)

NL: Newfoundland and Labrador

PC: Pacific Coast

WC (West Coast): Pacific Coast, Western Arctic and Athabasca-Mackenzie Watershed areas

All areas: includes East and West Coast areas

Notes:

1. An "A" following a channel number indicates simplex use of the ship station transmit side of an international duplex channel. Operations are different from that of international operations on that channel.
2. Channel 16 is used for calling other stations or for distress alerting.
3. The letter "B" following a channel number indicates simplex use of the coast station transmit side of an international duplex channel. That is, the channel is Receive Only.
4. Channel 70 is used exclusively for Digital Selective Calling (DSC) and is not available for regular voice communications.
5. Channels 75 and 76 are reserved as guard bands for Channel 16 and are not available for regular voice communications.

European Private Channels and Frequencies

In addition to the channels listed above in the International Marine VHF Channels & Frequencies table, your radio may also include some of the following private channels. Which channels are included depend upon the country in which the radio is to be operated and whether you possess the appropriate licensing.

Country	Channel Number	TX Freq	RX Freq	Channel Use
Belgium	96	162.425	162.425	Marina
Denmark	L1	155.500	155.500	Leisure
	L2	155.525	155.525	Leisure
Denmark, Finland, Norway & Sweden	F1	155.625	155.625	Fishing
	F2	155.775	155.775	Fishing
	F3	155.825	155.825	Fishing
Finland, Norway & Sweden	L1	155.500	155.500	Leisure
	L2	155.525	155.525	Leisure
	L3	155.650	155.650	Leisure
Netherlands	31	157.550	162.150	Marina
	37	157.850	157.850	Leisure
UK	M1	157.850	157.850	Marina
	M2	161.425	161.425	Marina

Note: A license may be required to operate the radio on the private channels. It is your responsibility to obtain the proper license to operate the radio on these frequencies.

Appendix E: Glossary

Term	Meaning
All Scan	A feature that scans all channels in the channel set.
All Ships Call	A DSC call that sends out a message to all vessels within range. The Ray218E/Ray55E can make two different types of All Ships calls: Safety Calls for advisory alerts or Urgency Calls when assistance is required but there is no imminent danger to the vessel.
ATIS	Automatic Transmitter Identification System. Used for inland waterways in some European countries.
Canadian Channels	Channel designations as defined by Industry Canada.
CH	Channel selection key
COG	Course Over Ground
Distress Call	A DSC call notifying other ships and shore stations that your vessel is in imminent danger, sending your position and time information, along with (optionally) the nature of your distress situation.
DSC	Digital Selective Calling (DSC) is a system used to send digital messages to stations identified by a unique MMSI number. Contained within the message is the working channel on which voice communications are to be made. DSC enables you to make digital Distress Calls and to specify the stations that you wish to contact: an Individual station, all stations within a specified Group, or All Ship stations within range.
Dual Watch	A feature that monitors the Priority Channel 16 and one other channel that you choose.
FCC	Federal Communications Commission (US)
Global Positioning System	A navigational system that uses satellite signals to determine the latitude and longitude of a receiver on Earth.
GPS	Global Positioning System
Group Call	A DSC call that sends transmissions only received by radios sharing a common Group MMSI number, such as a flotilla or racing fleet.
Individual Call	A DSC Call made to a specific station identified by its MMSI ID.
International Channels	Channel designations as defined by the ITU

Term	Meaning
ITU	International Telecommunications Union (EU)
MMSI	Maritime Mobile Service Identity; a number issued by each country to identify maritime stations, much like a telephone number.
NOAA	National Oceanographic and Atmospheric Administration (US)
Position Request	A DSC call requesting GPS position information from any station for which an MMSI number is known. You can also send out your position to other stations.
Priority Channel	Channel 16
Priority Scan	A feature that alternates monitoring the Priority Channel 16 with each of the regular channels.
PTT switch	Microphone push-to-talk switch
RF	Radio Frequency
RTCM	Radio Technical Commission for Maritime Services
RX	Receive
SAR	Search And Rescue
Saved Scan	Scans only user-selected memory channels
Semi-duplex	Channels using separate frequencies to transmit and receive.
Simplex	Channels transmitting and receiving on the same frequency.
SOG	Speed Over Ground
Squelch	A circuit that sets the threshold for cutting off the receiver when the signal is too weak for reception of anything but noise.
TX	Transmit
Tri Watch	A function that monitors the Priority Channel (16), the Secondary Priority (PLUS) Channel, and one other channel that you choose.
US Channels	Channel designations as defined by the FCC
VOL	Volume key
VHF	Very High Frequency (30MHz to 300MHz)
Working Channel	The currently-selected (non-priority, non-WX) channel

Index

Numerics

16/PLUS key 28, 29, 31

A

Adding channels to memory 49

Alert 35

All Scan function 45

All Ships Calls 89

Receiving 90

Transmitting 89

ATIS

Function 65

indicator 32

My ATIS ID 63

Operation 63

Automatic Channel Changing 33, 98

B

Backlight adjustment 66

Base in Use 35

Battery 35

Bearing Mode 67

C

Cable connections 20

Canadian channels 34, 117

Channel

Knob 28

Name 52

Tuning 36

UP/DOWN key 28, 31

Channel List 111

Canadian frequencies 117

International frequencies 111

US frequencies 114

CLEAR key 29, 31

Coast Stations 81

COG/SOG Display 61

Connections

cable 20

external speaker 22

GPS 23

hailer 22

NMEA 23

power 21

Contrast adjustment 66

Conventions 9

Customer Support 101

D

Deleting channels from memory 49

Display 32

Distress Calls 74

key 29

Receiving 77

Receiving Distress Relay 78

Sending a Designated call 75

Sending an Undesignated (QUICK) call 74

DSC 71

All Ships Calls 89

Call icon 33

Distress Calls 74

Group Calls 85

Individual Calls 81

key 31, 41

Log 94

Options 95

Menu 29, 71

Phonebook 78

DSC Settings

Automatic Channel Changing 98

Group MMSI Setup 85

My MMSI ID 96

Position Reply 99

Dual Watch 50

E

External speaker 22

F

FAV indicator 33

Favorite Channel 33, 53

Features 13

Fog Horn 29, 56

Frequency Band 51

Canadian channels 117

International channels 111

US channels 114

G

Glossary 123

GPS 24

indicator 33

Installing 23

Position Reply 99

setup 58

Group Calls 85

Receiving 87

Transmitting 86

Group MMSI Setup 85

H

Hailer 22, 29, 55

Handset 28, 106, 107

Help from Raymarine 101

HI/LO

indicator 32

key 28

power selection 48

High Voltage 22, 35

I

Individual Calls 81

Receiving 83

Transmitting 81

Installation 15

Intercom 29, 57

International channels 34, 111

Invalid Channel 84, 88, 91

K

Key Beep 67

Keypad 106

Keys 28

L

Last Received Position Request 93

Latitude/Longitude Display 60

LCD display 32

Local Mode 55

Log 94

Options 95

Low Voltage 22, 35

M

Memory

Adding channels to 49

Menu 29, 41

ATIS Operations 63

DSC Setup 96

GPS/Time Setup 58

Phonebook 78

Adding entries 79

Deleting entries 81

Editing entries 80

Settings 60

System Configuration 66

MENU/DSC key 29, 31, 41, 71

Messages 35, 94

Microphone 28, 41, 72, 106, 107

MMSI 96

Monitor Mode

Dual Watch 50

Tri Watch 50

My ATIS ID 63

My MMSI ID 96

N

NMEA connections 23

NMEA Output 61

O

OK/INTERCOM key 31

P

Phonebook 78

Adding entries 79

Deleting entries 81

Editing entries 80

PLUS channel 28, 29, 31, 38

Position Reply 99

Position Request 91

from Phonebook 92

receiving from another station 93

retrieving last received 93

Power 28

connections 21

ON/OFF 35

selection 48

Priority Channel 38

Priority Saved Scan function 47

Priority Scan function 46

PTT key 28, 30, 39

PWR/VOL key 28

R

Radio Setup

Channel Name 52

Favorite Channel 53

Frequency Band 51

Sensitivity 55

Raymarine

Addresses 101

Phone numbers 101

Web site 101

Raymic 30, 41, 57, 72, 107

Received Calls 94

Removing the sun cover 15

Repair 101

Reset 69

RX indicator 32

S

Save 28

SAVED indicator 32

Saved Scan function 46

Scan Mode 44

All Scan 45

Priority All Scan 46

Priority Saved Scan 47

Saved Scan 46

SCAN/SAVE key 28

Secondary Priority (PLUS) Channel 28, 29, 31, 38

Sensitivity 55

Service 101

Settings 60, 96

COG/SOG Display 61

Latitude/Longitude Display 60

Time Display 60

Time Format 60

Time Offset 60

Signal Bar 67

Soft keys 29, 31

Speaker 22

Specifications 103

Speed Unit 68

Squelch 28, 30, 36

Standard equipment 16, 20

Sun cover removal 15

System Configuration 66

Backlight 66

Bearing Mode 67

Contrast 66

Key Beep 67

Reset 69

Signal Bar 67

Speed Unit 68

System Test 68

Version Number 69

System Test 68

T

Time

Display 60

Format 60

Offset 60

Setup 58

Transmitting 39

Tri Watch 50

TX 32, 39

U

Unable to Comply 84, 88, 91, 95

US channels 34, 114

UTC time setup 58

V

Version Number 69

Voltage 21

high 35

low 35

Volume 28, 30, 36

W

Warranty 9

Weather Alert 33, 37

Weather channels 37

Web site 101

Wire connections 20

WX 37

X

XCLUDE 44

