



MERCURY[®]
GO BOLDLY.™

8M0215918 323 eng



**Operation
Maintenance
and
Installation
Manual**

Avator 7.5e Electric Outboard

© 2023 Mercury Marine



Scan for service and support information

Welcome

You have selected one of the finest marine power packages available. It incorporates numerous design features to ensure operating ease and durability. With proper care and maintenance, you will enjoy using this product for many boating seasons. To ensure maximum performance and carefree use, we ask that you thoroughly read this manual.

The Operation and Maintenance Manual contains specific instructions for using and maintaining your product. Keep this manual with the product for ready reference whenever you are on the water.

Thank you for purchasing one of our products. We sincerely hope your boating will be pleasant.

Mercury Marine, Fond du Lac, Wisconsin, U.S.A.

Name / function:

John Buelow, President
Mercury Marine



Read This Manual Thoroughly

IMPORTANT: If you do not understand any portion of this manual, contact your dealer. Your dealer can also provide a demonstration of actual operating procedures.

Notice

Throughout this publication and on your power package, safety alerts labeled

WARNING and CAUTION (accompanied by the symbol ) , are used to alert you to special instructions concerning a particular service or operation that may be hazardous if performed incorrectly or carelessly. Observe these alerts carefully.

These safety alerts alone cannot eliminate the hazards that they signal. Strict compliance to these special instructions when performing the service, plus common sense operation, are major accident prevention measures.

WARNING

Indicates a hazardous situation which, if not avoided, could result in death or serious injury.

▲ CAUTION

Indicates a hazardous situation which, if not avoided, could result in minor or moderate injury.

Additional alerts provide information that requires special attention:

NOTICE

Indicates a situation which, if not avoided, could result in motor damage, battery damage, or component failure.

IMPORTANT: Identifies information essential to the successful completion of the task.

NOTE: Indicates information that helps in the understanding of a particular step or action.

IMPORTANT: The operator (driver) is responsible for the correct and safe operation of the boat, the equipment aboard, and the safety of all occupants aboard. Mercury Marine strongly recommends that the operator read this Operation and Maintenance Manual and thoroughly understand the operational instructions for the power package and all related accessories before the boat is used.

California Proposition 65



WARNING: This product can expose you to chemicals, which are known to the State of California to cause cancer and birth defects or other reproductive harm. For more information go to www.P65Warnings.ca.gov.

Descriptions and specifications contained herein were in effect at the time this was approved for printing. Mercury Marine, whose policies are based on continuous improvement, reserves the right to discontinue models at any time or to change specifications or designs without notice and without incurring obligation.

Warranty Message

The product you have purchased comes with a **Mercury Marine Limited Warranty**. The terms of the warranty are set forth in the Warranty Manual, which can be accessed any time on the Mercury Marine website, at <http://www.mercurymarine.com/warranty-manual>. The Warranty Manual contains a description of what is covered, what is not covered, the duration of coverage, how to best obtain warranty coverage, **important disclaimers, limitations, and waivers**, and other related information. Please review this important information.

Mercury Marine products are designed and manufactured to comply with our own high quality standards, applicable industry standards and regulations, and certain emissions regulations. At Mercury Marine every outboard is operated and tested before it is boxed for shipment to make sure that the product is ready for use. In addition, certain Mercury Marine products are tested in a controlled and monitored environment, for up to 10 hours of outboard run time, in order to verify and make a record of compliance with applicable standards and regulations. All Mercury Marine product, sold as new, receives the applicable limited warranty coverage, whether the outboard participated in one of the test programs described above or not.

Copyright and Trademark Information

© **MERCURY MARINE. All rights reserved. Reproduction in whole or in part without permission is prohibited.**

Alpha, Avator, Axis, Bravo One, Bravo Two, Bravo Three, Circle M with Waves Logo, GO BOLDLY, K-planes, Mariner, MerCathode, MerCruiser, Mercury, Mercury with Waves Logo, Mercury Marine, Mercury Precision Parts, Mercury Propellers, Mercury Racing, MotorGuide, OptiMax, Pro XS, Quicksilver, SeaCore, Skyhook, SmartCraft, Sport-Jet, Verado, VesselView, Zero Effort, Zeus, #1 On the Water and We're Driven to Win are registered trademarks of Brunswick Corporation. Mercury Product Protection is a registered service mark of Brunswick Corporation. All other marks are the property of their respective owners.

Identification Records

The serial numbers are the manufacturer's keys to numerous engineering details that apply to your Mercury Marine power package. When contacting Mercury Marine about service, **always specify Avator outboard and battery serial numbers.**

Please record the following applicable information:

Outboard		
Outboard Model and Horsepower		
Outboard Serial Number		
Battery Serial Number(s)		
Spare Battery Serial Number(s)		
Propeller Part Number	Pitch*	
Watercraft Identification Number (WIN) or Hull Identification Number (HIN)		Purchase Date
Boat Manufacturer	Boat Model	Length

NOTE: *The Avator 7.5e ships with a 17.9 cm (7 in.) pitch propeller as standard. Optional propellers in the pitches of 22.9 cm (9 in.) and 27.9 cm (11 in.) may be purchased from an authorized dealer or through alternative means. Do not use aftermarket propellers with this product as damage may occur.

General Information

Boater's Responsibilities.....	1
Start-In-Neutral-Protection Device.....	1
Lanyard Stop Switch.....	2
Protecting People in the Water.....	5
Passenger Safety Message - Pontoon Boats and Deck Boats.....	5
Wave and Wake Jumping.....	7
Impact with Underwater Hazards.....	7
Outboard Secure Fastening to Transom Safety Instruction.....	9
Safe Boating Recommendations.....	10
Guardian Safety Feature.....	13
Conditions Affecting Performance.....	13
Recording Serial Numbers.....	15
Component Identification.....	17
Specifications.....	19

Battery

Battery Safety Information.....	21
Battery Disposal and Recycling.....	23
Battery Management System.....	24
Battery Connector.....	25
Battery Charger Selection.....	25
Charging the Battery.....	25
Battery Care.....	26
Battery Storage, Usage, and Charging Temperature Ranges.....	27
Battery State of Charge (SOC) Status.....	28
Battery Charging Status.....	29
Battery Faults.....	30
Battery Installation.....	30
Battery Removal.....	33
Battery Storage Preparation.....	35
Battery Storage.....	36

Installation

Installation Information.....	39
Installing the Outboard.....	40
Quick-Release - Tiller Models Only.....	44
Lifting the Outboard.....	47
Remote Control Steering Cable Connections.....	48
Cowl Replacement.....	51
Remote Wiring Harness Installation.....	60
Remote Control Diagram.....	63

Transporting

Aquatic Invasive Species (AIS).....	65
Handling the Outboard Separately From the Boat - Tiller Models Only.....	65
Carrying Bag (Optional Accessory).....	67
Trailer for Transportation.....	67

Features and Controls

Tiller Handle Features.....	69
Copilot (Steering Friction Adjustment).....	72
Remote Control Features.....	73
Helm-Mounted Lanyard Stop Switch.....	74
Avator Outboard Trim System.....	75
Warning Horn.....	79
Audio Warning System.....	79
Display Icon Legend.....	80
SmartCraft CONNECT Installation - Tiller Models.....	84
Near Field Chipset (NFC) Decal and Mercury Marine App.....	86

Operation

Prestarting Check List.....	89
Prestarting Instructions.....	89
Powering On/Off the Outboard: Tiller Models.....	90
Powering On/Off the Outboard: Remote Control Models.....	91
Operating the outboard - Remote Control Models.....	93
Operating the outboard - Tiller Handle Models.....	95
Outboard Settings - Tiller Models.....	96
Outboard Settings - Remote Control Models.....	100
Using and Changing Directional Controls.....	101
Powering Down the Outboard.....	103
Recommended Operating Temperature Ranges for the Avator 7.5e Outboard	104
Operating in Saltwater or Polluted Water.....	104

Maintenance

Cleaning Care.....	105
Inspection and Maintenance Schedule.....	106
Corrosion Control Anode.....	108
Propeller Replacement.....	109

Outboard Storage

Protecting External Outboard Components.....	113
Outboard Storage.....	113

Troubleshooting

Fuse Replacement.....	115
Outboard Will Not Power Up.....	116
Outboard Losing Power Intermittently.....	116
Performance Loss.....	116
Battery Will Not Hold Charge.....	117
Battery Will Not Charge with Charger.....	117

Operator Service Assistance

Service Assistance.....	119
Handling Damaged, Defective, or Submerged Products.....	121
Ordering Literature.....	122

Maintenance Log

Maintenance Log.....	125
----------------------	-----

Predelivery Inspection (PDI)

Predelivery Inspection (PDI).....	127
-----------------------------------	-----

GENERAL INFORMATION

Boater's Responsibilities

The operator (driver) is responsible for the correct and safe operation of the boat and the safety of its occupants and general public. It is strongly recommended that each operator read and understand this entire manual before operating, charging, or storing the outboard.

Be sure that at least one additional person onboard is instructed in the basics of starting and operating the outboard and boat handling in case the driver is unable to operate the boat.

Start-In-Neutral-Protection Device

The tiller handle shift controller or the remote control connected to the outboard is equipped with a start in neutral only protection device. This prevents the outboard from activating when the remote control or tiller control is placed in any position other than neutral at the time it is powered on. This means that if the outboard is powered up while the shift control on the tiller or remote control is in a forward or reverse position, the outboard will not activate unless the shift control position is returned to neutral first.

WARNING

Powering ON the outboard with the remote control or tiller in forward or reverse is not recommended and can cause serious injury or death. Never operate a boat with a malfunctioning neutral-safety-protection device.

The start-in-neutral-protection device is designed to prevent the outboard from activating even if the remote control or the tiller control grip are in a reverse or forward position when the key is turned to the **ON** position.

GENERAL INFORMATION

The start-in-neutral-protection device is designed to prevent the outboard from activating if the display is powered up on the tiller models. However, before activating the power up sequence check to make sure that the remote control or the tiller control grip is in the neutral position.



Lanyard Stop Switch

The purpose of a lanyard stop switch is to stop the outboard when the operator moves far enough away from the operator's position (as in accidental ejection from the operator's position) to activate the switch. Tiller handle outboards and panel mounted lanyard switches provide similar functionality and will stop or prevent propeller rotation as soon as the lanyard is displaced from its installed location.

Remote control models only - the lanyard stop switch can be installed as an accessory - generally on the dashboard or side adjacent to the operator's position.

A decal near the lanyard stop switch is a visual reminder for the operator to attach the lanyard to their personal flotation device (PFD) or wrist.

NOTE: *Wireless Man Overboard Protection (MOB) devices are not considered a substitute for the protection offered by the lanyard stop switch.*

GENERAL INFORMATION

The lanyard cord is usually 122–152 cm (4–5 feet) in length when stretched out, with an element on one end made to be inserted into the switch and a clip on the other end for attaching to the operator's PFD or wrist. The lanyard is coiled to make its at-rest condition as short as possible to minimize the likelihood of lanyard entanglement with nearby objects. Its stretched-out length is made to minimize the likelihood of accidental activation should the operator choose to move around in an area close to the normal operator's position. If it is desired to have a shorter lanyard, wrap the lanyard around the operator's wrist or leg, or tie a knot in the lanyard.

NOTE: There is a temporary lanyard key without a lanyard cord located on and under the hood of the outboard. Use this in case of emergency to get back underway in the event of loss of the lanyard. If the operator using the lanyard falls overboard, use the temporary lanyard key to maneuver the boat back to the operator.

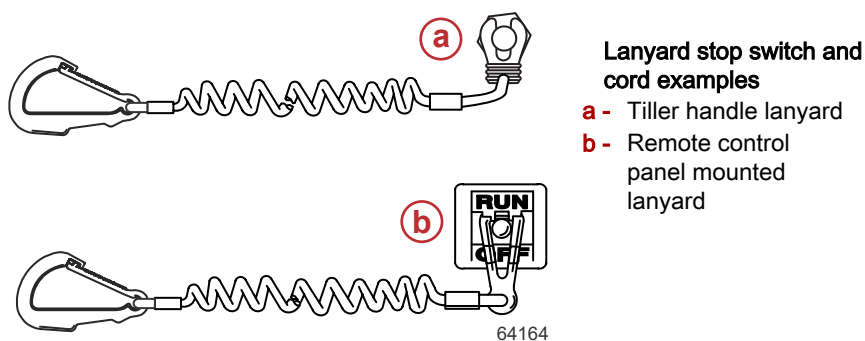

Read the following Safety Information before proceeding.

Important Safety Information: The purpose of a lanyard stop switch is to stop the outboard when the operator moves far enough away from the operator's position to activate the switch. This would occur if the operator accidentally falls overboard or moves within the boat a sufficient distance from the operator's position. Falling overboard and accidental ejections are more likely to occur in certain types of boats such as kayaks, canoes, low sided inflatables, as well as light, sensitive handling fishing boats that are operated by a hand tiller. Falling overboard and accidental ejections are also likely to occur as a result of poor operating practices such as sitting on the back of the seat or gunwale, standing, or sitting on elevated fishing boat decks, operating at unsafe speeds in shallow or obstacle infested waters, releasing the grip on a steering wheel or tiller handle that is pulling in one direction, drinking alcohol or consuming drugs, or daring high speed boat maneuvers.

While activation of the lanyard stop switch will stop the outboard immediately, a boat will continue to coast for some distance depending upon the velocity and degree of any turn at shut down. However, the boat will not complete a full circle. While the boat is coasting, it can cause injury to anyone in the boat's path as seriously as the boat would when under power.

GENERAL INFORMATION

Mercury Marine strongly recommends that other occupants be instructed on proper starting and operating procedures should they be required to operate the outboard in an emergency (if the operator is accidentally ejected).

⚠ WARNING

If the operator falls out of the boat, stop and power off the outboard immediately to reduce the possibility of serious injury or death from being struck by the boat. Always properly connect the operator to the stop switch using a lanyard.

⚠ WARNING

Avoid serious injury or death from deceleration forces resulting from accidental or unintended stop switch activation. The boat operator should never leave the operator's station without first disconnecting the stop switch lanyard from the operator.

Accidental or unintended activation of the switch during normal operation is also a possibility. This could cause any, or all, of the following potentially hazardous situations:

- Occupants could be thrown forward due to unexpected loss of forward motion - a particular concern for passengers in the front of the boat who could be ejected over the bow and possibly struck by the outboard lower unit or propeller.
- Loss of power and directional control in heavy seas, strong current, or high winds.
- Loss of control when docking.

KEEP THE LANYARD STOP SWITCH AND LANYARD CORD IN GOOD OPERATING CONDITION

Before each use, check to ensure the lanyard stop switch works properly. Power up, and engage the outboard and stop it by pulling the lanyard cord. If the outboard does not stop, have the switch repaired before operating the boat.

Before each use, visually inspect the lanyard cord to ensure it is in good working condition and that there are no breaks, cuts, or wear to the cord. Check that the clips on the ends of the cord are in good condition. Replace any damaged or worn lanyard cords.

GENERAL INFORMATION

Protecting People in the Water

WHILE BOAT IS IN OPERATION

People in the water cannot take quick action to avoid a boat heading in their direction.



Approach slowly and exercise extreme caution when boating in areas where people may be in the water.

When a boat is moving and the controller shift position is in neutral, there is sufficient force by the water on the propeller to cause the propeller to rotate. This neutral propeller rotation can cause serious injury.

WHILE THE BOAT IS STATIONARY

▲ WARNING

A spinning propeller, a moving boat, or any solid device attached to the boat can cause serious injury or death to swimmers. Stop and power down the outboard immediately whenever anyone in the water is near the boat.

Shift into neutral and power down the outboard before allowing people in the water near the boat.

Passenger Safety Message - Pontoon Boats and Deck Boats

Whenever the boat is in motion, observe the location of all passengers. Do not allow any passengers to stand or use seats other than those designated for traveling faster than idle speed. A sudden reduction in boat speed, such as plunging into a large wave or wake, a sudden throttle reduction, or a sharp change of boat direction, could throw them over the front of the boat. Falling over the front of the boat between the two pontoons will position them to be run over by the outboard.

BOATS HAVING AN OPEN FRONT DECK

No one should ever be on the deck in front of the fence while the boat is in motion. Keep all passengers behind the front fence or enclosure.

GENERAL INFORMATION

Persons on the front deck could easily be thrown overboard or persons dangling their feet over the front edge could get their legs caught by a wave and pulled into the water.

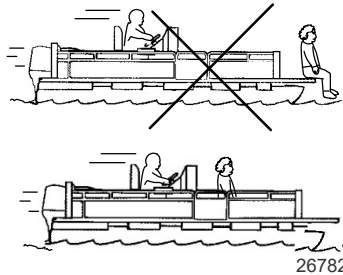

⚠ WARNING

Sitting or standing in an area of the boat not designed for passengers at speeds above idle can cause serious injury or death. Stay back from the front end of deck boats or raised platforms and remain seated while the boat is in motion.

BOATS WITH FRONT MOUNTED, RAISED PEDESTAL FISHING SEATS

Elevated fishing seats are not intended for use when the boat is traveling faster than idle or trolling speed. Sit only in seats designated for traveling at faster speeds.

Any unexpected, sudden reduction in boat speed could result in the elevated passenger falling over the front of the boat.

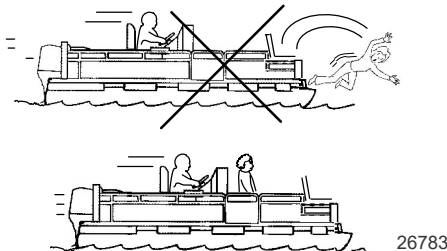

GENERAL INFORMATION

Wave and Wake Jumping

Operating recreational boats over waves and wake is a natural part of boating. However, when this activity is done with sufficient speed to force the boat hull partially or completely out of the water, certain hazards arise, particularly when the boat enters the water.

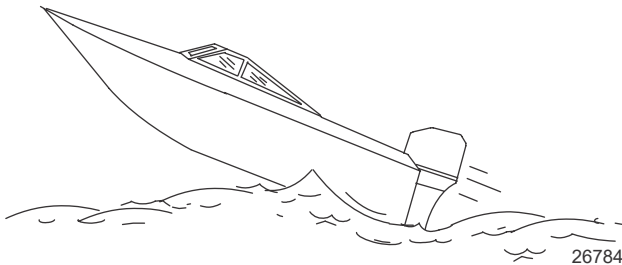

The primary concern is the boat changing direction while in the midst of the jump. In such case, the landing may cause the boat to veer violently in a new direction. Such a sharp change in direction can cause occupants to be thrown out of their seats, or out of the boat.

▲ WARNING

Wave or wake jumping can cause serious injury or death from occupants being thrown within or out of the boat. Avoid wave or wake jumping whenever possible.

There is another less common hazardous result from allowing the boat to launch off a wave or wake. If the bow of the boat pitches down far enough, upon water contact it may penetrate under the water surface and submarine for an instant. This will bring the boat to a nearly instantaneous stop and can send the occupants flying forward. The boat may also steer sharply to one side.

Impact with Underwater Hazards

The outboard is designed to absorb impacts with underwater objects at low speeds with no permanent damage to components. At higher speeds, the force of the impact may exceed the system's ability to absorb the energy of the impact and cause serious product damage.

No impact protection exists while in reverse. Use extreme caution when operating in reverse to avoid striking underwater objects.

GENERAL INFORMATION

Reduce speed and proceed with caution when driving a boat in shallow water areas or in areas where suspected underwater obstacles may exist that could be struck by the outboard or the boat bottom. **The most significant action the operator can take to help reduce injury or impact damage from striking a floating or underwater object is to control the boat speed. Under these conditions, boat speed should be kept 1.5 to 8 km/h (1 to 5 mph).**

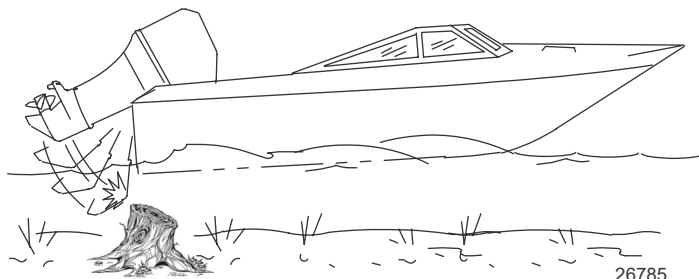

⚠ WARNING

Avoid serious injury or death from all or part of an outboard or drive unit coming into the boat after striking a floating or underwater object. When operating in waters where objects may be at the surface or just under the surface of the water, reduce your speed and keep a vigilant lookout.

Examples of objects that can cause outboard damage are dredging pipes, bridge supports, wing dams, trees, stumps, and rocks.

Striking a floating or underwater object could result in any of an infinite number of situations. Some of these situations could yield the following:

- Part of the outboard or the entire outboard could break loose and fly into the boat.
- The boat could move suddenly in a new direction. A sharp change in direction can cause occupants to be thrown out of their seats or out of the boat.
- The boat's speed could rapidly reduce. This will cause occupants to be thrown forward or even out of the boat.
- The outboard or boat could sustain impact damage.

After striking a submerged object, stop and power down the outboard as soon as possible and inspect it for any broken or loose parts. Further, if damage is present or suspected, power down the outboard, remove or disconnect the battery and do not continue to use the outboard. The outboard should be taken to an authorized dealer for a thorough inspection and necessary repair.

The boat should also be checked for any hull fractures, transom fractures, or water leaks. If water leaks are discovered after an impact, immediately activate the bilge pump.

GENERAL INFORMATION

Operating a damaged outboard could cause additional damage to other parts of the outboard or could affect control of the boat. If continued operation is necessary, do so at greatly reduced speeds.

⚠ WARNING

Operating a boat or outboard with impact damage can result in product damage, serious injury, or death. If the boat experiences any form of impact, have an authorized Mercury Marine dealer inspect and repair the boat or power package.

Outboard Secure Fastening to Transom Safety Instruction

No person or cargo should occupy the area directly in front of the outboard while the boat is in motion. If an underwater obstacle is struck, the outboard will tilt up and could seriously injure a person occupying this area.

MODELS WITH CLAMP SCREWS

Some outboards come with transom bracket clamp screws. The use of clamp bracket screws alone is insufficient to properly and safely secure the outboard to the transom. Proper installation of the outboard includes bolting the outboard to the boat through the transom. Refer to **Installing Outboard**.

⚠ WARNING

Failure to correctly fasten the outboard could result in the outboard propelling off the boat transom resulting in property loss, damage, serious injury, or death. Before operation, the outboard must be correctly installed with the required mounting hardware.

GENERAL INFORMATION

The outboard must be secured to the transom with the required mounting hardware. If the outboard strikes an underwater object, the required mounting hardware prevents the outboard from propelling off the transom. A decal on the swivel bracket reminds the installer of the potential hazard.



Safe Boating Recommendations

To safely enjoy the waterways, be familiar with local and all other governmental boating regulations and restrictions and consider the following suggestions.

Know and obey all nautical rules and laws of the waterways.

- Mercury Marine recommends that all powerboat operators complete a boating safety course. In the U.S., the U.S. Coast Guard Auxiliary, the Power Squadron, the Red Cross, and the state or provincial boating law enforcement agency provide courses. For more information in the U.S., call the Boat U.S. Foundation at 1-800-336-BOAT (2628).

Perform safety checks and required maintenance.

- Follow a regular schedule and ensure that all repairs are properly made.

Check safety equipment onboard.

- Here are some suggestions of the types of safety equipment to carry when boating:
 - Approved fire extinguishers
 - Signal devices: flashlight, rockets or flares, flag, and whistle or horn
 - Tools necessary for minor repairs
 - Anchor and extra anchor line
 - Manual bilge pump and extra drain plugs

GENERAL INFORMATION

- Drinking water
- Radio
- Paddle or oar
- Spare propeller, sheer pin, and an appropriate wrench
- First aid kit and instructions
- Waterproof storage containers
- Spare operating equipment, batteries, bulbs, and fuses
- Compass and map or chart of the area
- Personal flotation device (one per person onboard)

Watch for signs of weather change and avoid foul weather and rough-sea boating.

Tell someone the intended location and the expected time of return.

Passenger boarding.

- Stop and power off the outboard whenever passengers are boarding, unloading, or are near the back (stern) of the boat. Shifting the control handle or tiller into neutral is not sufficient.

Use personal flotation devices.

- Federal law requires that there be a U.S. Coast Guard-approved life jacket (personal flotation device), correctly sized and readily accessible for every person onboard, plus a throwable cushion or ring. Mercury Marine strongly advises that everyone wear a life jacket at all times while in the boat.

Prepare other boat operators.

- Instruct at least one person onboard in the basics of starting and operating the outboard and boat handling in case the driver becomes disabled or falls overboard.
- Tiller models only, ensure that there is a spare lanyard clip installed on the bottom of the outboard hood in case the operator falls overboard, and boat mobility is required to maneuver back to the operator's location.

Do not overload the boat.

- Most boats are rated and certified for maximum load (weight) capacities (refer to the boat's capacity plate). Know the boat's operating and loading limitations. Know if the boat will float if it is full of water. When in doubt, contact the authorized Mercury Marine dealer or the boat manufacturer.

Ensure that everyone in the boat is properly seated.

GENERAL INFORMATION

- Do not allow anyone to sit or ride on any part of the boat that was not intended for such use. This includes the backs of seats, gunwales, transom, bow, decks, raised fishing seats, and any rotating fishing seat. Passengers should not sit or ride anywhere that sudden unexpected acceleration, sudden stopping, unexpected loss of boat control, or sudden boat movement could cause a person to be thrown overboard or into the boat. Ensure that all passengers have a proper seat and are in it before any boat movement.

Never operate a boat while under the influence of alcohol or drugs. It is the law.

- Alcohol or drugs can impair the operators judgment and greatly reduce the operators ability to react quickly.

Know the boating area and avoid hazardous locations.

Be alert.

- The operator of the boat is responsible by law to maintain a proper lookout by sight and hearing. The operator must have an unobstructed view particularly to the front. No passengers, load, or fishing seats should block the operator's view when the boat is above idle or planing transition speed. Watch out for others, the water, and the boat's wake.

Never drive the boat directly behind a water-skier.

- The boat traveling at speeds above 16 km/h (10 mph) can overtake a fallen skier before driver reactions can have an affect on boat course or speed.

Watch for fallen skiers.

- When using the boat for tow sports such as tubing or similar activities, always keep a fallen or down person on the operator's side of the boat while returning to attend to the person. The operator should always have the down person in sight and never back up to the person or anyone in the water.

Report accidents.

- Federal law requires the operator or owner of a recreational boat to file a boating accident report with the State reporting authority if the recreational boat is involved in an accident that results in any of the following:
 - A person dies.
 - A person is injured and requires medical treatment beyond first aid.
 - A person disappears from the boat under circumstances that indicate death or injury.
 - Damage to boats and other property totals \$2,000 (lower amounts in some states and territories).
 - The boat is destroyed.

GENERAL INFORMATION

Guardian Safety Feature

The outboard motor is equipped with electronic monitoring of the battery and motor for conditions affecting safe operations. Mercury Marine refers to this system as Guardian. In the event that the Guardian system detects conditions of operation outside of safe parameters it will notify the operator with an audible warning.

There are two types of audible warnings. A series of six beeps indicates a cautionary system state or a solid six second horn to indicate a critical system state. In the caution state, Guardian may reduce power to 65% available power, minimally disrupting normal operation. In the critical system state, a parameter has exceeded safe operation. In this state, Guardian may reduce power to 5% available power. For more information refer to **Audio Warning System**.

Conditions Affecting Performance

WEATHER

It is a known fact that weather conditions exert a profound effect on the power output of outboard motors. Established power ratings refer to the power the outboard produces at the propeller shaft. The rating does not take into account external forces such as current or wind.

Summer conditions of ambient air temperature, direct sunlight, and high humidity can reduce the battery and motor ability to maintain low operating temperatures. During use, if the battery core internal temperature exceeds 60 °C (140 °F), a critical battery overheat fault will occur and the battery will shut down. As a result, the outboard will not power up until the battery core temperature is reduced. In elevated, but non-critical battery overheat events, battery core temperatures of 50 °C (122 °F) will result in a temperature elevated non-critical fault with audible alarm and fault indication of a battery over temperature event. Power available for use will be restricted by the Guardian protective feature within the outboard controller.

WEIGHT DISTRIBUTION (PASSENGERS AND GEAR) INSIDE THE BOAT

Shifting weight to rear (stern):

- Generally increases speed and outboard RPM.
- Causes the bow to bounce in choppy water.
- Decreases forward visibility of the boat when traveling at higher speeds.
- Weight extremes can cause the boat to porpoise.

Shifting weight to front (bow):

- Improves forward visibility during higher speeds.
- Improves rough water ride.
- Weight extremes, can cause the boat to veer back and forth (bow steer).

GENERAL INFORMATION

BOTTOM OF BOAT

For maximum speed, the bottom of the boat should be nearly a flat plane where it contacts the water and particularly straight and smooth in fore and aft direction.

- **Hook:** Hook exists when the bottom of the boat is concave in the fore and aft direction when viewed from the side. When the boat is planing, hook causes more lift on the bottom near the transom and allows the bow to drop, greatly increasing wetted surface and reducing the boat speed. Hook frequently is caused by supporting the boat too far ahead of the transom while hauling on a trailer or during storage.
- **Rocker:** Rocker exists if the bottom of the boat is convex in the fore and aft direction when viewed from the side, and the boat has a strong tendency to porpoise.
- **Surface roughness:** Moss, barnacles, etc., on boat or corrosion of the outboard's motor lower unit housing increases surface friction and can cause speed loss. Clean surfaces when necessary.

WATER ABSORPTION

It is imperative that all through-the-hull fasteners be coated with a quality marine sealer at time of installation. Water intrusion into the transom core and/or inner hull will result in additional boat weight (reduced boat performance), hull decay, and eventual structural failure.

CAVITATION

Cavitation occurs when water flow cannot follow the contour of a fast-moving underwater object, such as an outboard lower unit housing or a propeller. Cavitation increases propeller speed while reducing boat speed. Cavitation can seriously erode the surface of the motor lower unit housing or the propeller. Common causes of cavitation are:

- Weeds or other debris snagged on the propeller
- Warped, nicked, broken, or missing propeller blade
- Raised burrs or sharp edges on the propeller

CLIMATE

Climate changes may affect the performance of the power package. Over-temperature faults, reduced available power, and battery shut-down can be caused by:

- Higher temperatures
- High humidity

GENERAL INFORMATION

PROPELLER

The Avator outboard comes pre-equipped with a 17.8 cm (7 in.) inch pitch propeller. At the time of this manual printing, Mercury Marine sells an optional 22.9 cm (9 in.) inch pitch propeller and an 27.9 cm (11 in.) inch pitch propeller. Choosing another propeller should take into account low-speed handling characteristics which may be affected negatively by a higher-pitch propeller, as well as range which may be affected negatively by a lower pitch propeller. Top speed may be lost by choosing a propeller that is either higher or lower in pitch than the current propeller.

Recording Serial Numbers

OUTBOARD SERIAL NUMBER

Record the motor serial number for future reference. The outboard serial number is located on the outboard as shown.

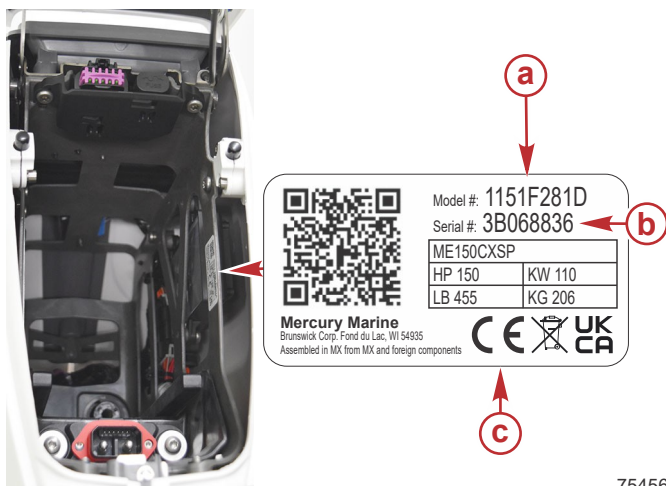

75456

- a** - Model designation
- b** - Serial number
- c** - Certified Europe Insignia (as applicable)

GENERAL INFORMATION

BATTERY SERIAL NUMBER

Record the battery serial number for future reference. The battery serial number is located on the battery as shown.



- a** - Model designation
- b** - Serial number
- c** - Certified Europe Insignia (as applicable)

75646

GENERAL INFORMATION

Component Identification

REMOTE CONTROL MODEL

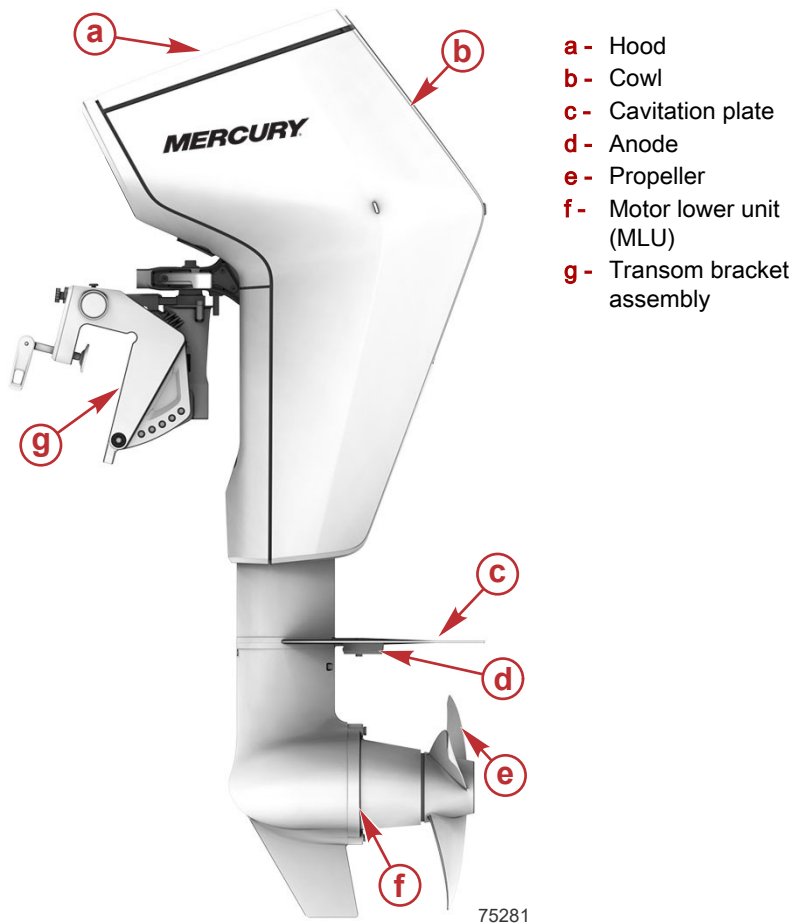

GENERAL INFORMATION

TILLER MODEL

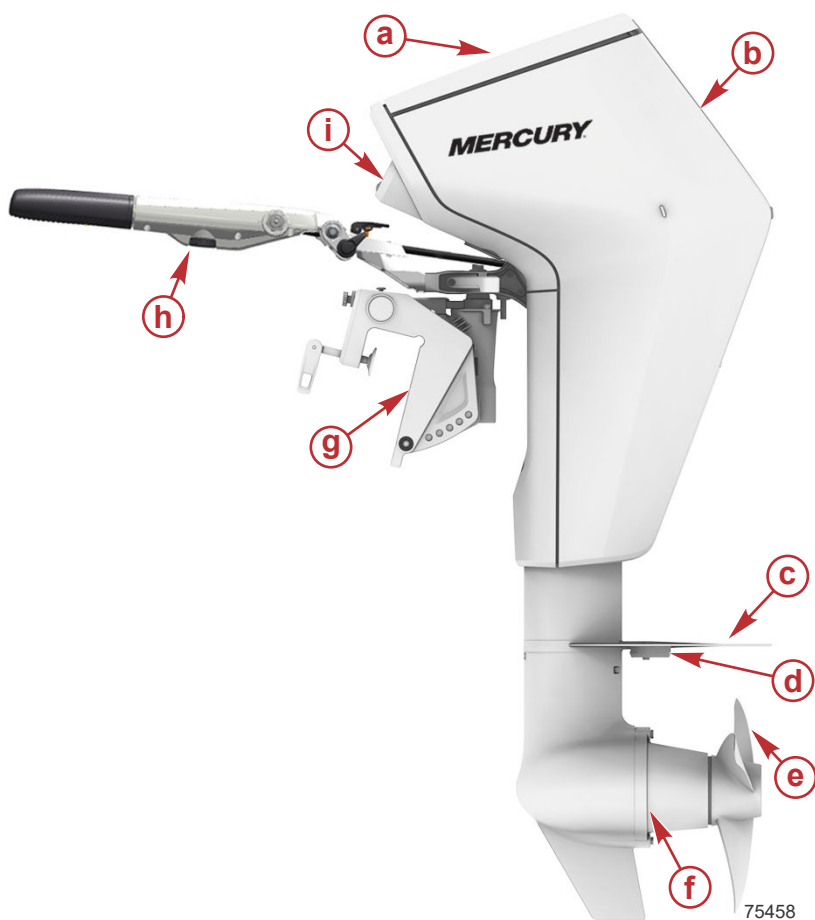

- a** - Hood
- b** - Cowl
- c** - Cavitation plate
- d** - Anode
- e** - Propeller
- f** - Motor lower unit (MLU)
- g** - Transom bracket assembly
- h** - Tiller handle
- i** - Display

GENERAL INFORMATION

Specifications

Parameter		Specification
Outboard power rating		750 W
Weight	S (without battery)	19.5 kg (43.0 lb)
	L (without battery)	20.5 kg (45.2 lb)
	XL (without battery)	21.0 kg (46.3 lb)
	Battery	7.7 kg (17 lb)
Shaft length	Standard	38.1 cm (15 in.)
	L	50.8 cm (20 in.)
	XL	63.5 cm (25 in.)
Rated maximum propeller speed range		800-900 RPM
Propeller (Do not use aftermarket propellers with this product as damage may result.)	Standard pitch	7 in.
	Optional pitch (may be purchased from the local dealer)	9 in. 11 in.
Trim angles		Five manual trim positions
Battery type		Integrated, portable
Battery rating		1030 Wh
Battery maximum continuous discharge current		20.5 A
Battery nominal voltage		50.4 V DC
Battery IP rating		IP67
Battery chemistry		Lithium nickel manganese cobalt oxide (LiNiMnCoO ₂)
Battery operating temperature range		0-45 °C (32-113 °F)
Battery charging temperature range		0-45 °C (32-113 °F)
Battery storage temperature range	One month	0-60 °C (32-140 °F)
	Three months	0-45 °C (32-113 °F)
	One year	0-25 °C (32-77 °F)

GENERAL INFORMATION

Notes:

BATTERY

Battery Safety Information

IMPORTANT: Save these instructions.

SAFETY INSTRUCTIONS

- Read these Safety Instructions as well as the Safety Instructions, Operation Instructions, and Specifications stated in the Operation, Maintenance, and Installation manual before using the Mercury Avator outboard or battery.
- Failure to observe these instructions may result in electrical shock, fire, or serious injury.
- Keep these Safety Instructions in a secure place for future reference.
- Non-compliance with the Safety Instructions, Operation Instructions, and Specifications; repairs made with other than original parts; or repairs made without authorization will void the Mercury Marine Limited Warranty for the battery.
- Do not open or attempt to service the Mercury Avator outboard battery. Work on the Mercury Avator outboard motor/battery must be carried out by a Mercury Marine Authorized Dealer for warranty coverage to apply.
- Only use the Mercury Avator outboard motor/battery if it is complete and in good serviceable condition.
- Keep the Mercury Avator outboard motor/battery away from children.
- Protect the Mercury Avator battery against heat and fire. Do not store or operate the Mercury Avator battery in the presence of flammable vapors or in flammable dust environments. Do not submerge the Mercury Avator battery in water.
- Switch off all charging systems and remove the Mercury Avator battery from the battery charger or outboard motor before performing inspections, assembly, maintenance, and repair activities.
- Do not short-circuit the electrical contacts of the Mercury Avator battery, as this may result in fire, burns, explosion, or release of toxic gas. Keep the Mercury Avator battery away from objects that may cause short circuits, like tools, screws, nails, watches, bracelets, necklaces, keys, or other metal objects.
- The Mercury Avator battery may generate heat during charging. Before charging, the Mercury Avator battery must be placed on a fireproof surface, in a dry and well-ventilated environment.
- Do not leave the Mercury Avator battery unattended while charging.
- Never charge a Mercury Avator battery:
 - a. In the vicinity of flammable materials.
 - b. With a charger other than the one specifically designated for the Mercury Avator battery.
 - c. If the battery indicates a permanent fault. (Refer to **Battery Faults**).
 - d. That is damaged, frozen, or overcharged.

BATTERY

- Handle the Mercury Avator battery with care. Do not crush the Mercury Avator battery or subject it to mechanical shock.
- Only use the provided handles to carry the Mercury Avator battery.
- Use the original packaging or equivalent for transportation of the Mercury Avator battery. When transported, it must be placed in the upright position or on its side.

The voltage range (35V – 58.5V) is greater than may be expected from other battery types such as lead-acid batteries. Even when thought to be discharged, the Mercury Avator battery and connections can still have hazardous voltage levels.

⚠ CAUTION

Leaking electrolytes or gases from a damaged battery can cause injury to the skin, eyes, and respiratory system. Avoid contact with skin and eyes. Never inhale gases directly.

⚠ CAUTION

Electrical shock and severe injury can result from contact with uninsulated or damaged parts, wiring, or electrical connections.

- **Avoid touching the electrical contacts.**
- **Never attempt any battery repair work.**
- **Never touch chaffed, damaged, or severed wiring or obviously defective components.**
- **Prevent chaffing, rubbing, or abrading to the batteries, wiring, and cables.**

FIRST AID

Refer to the Material Safety Data Sheet for lithium-ion batteries, which is available on www.mercurymarine.com.

- In case of fire, use fire-extinguishing powder, water, or sand to extinguish the fire.
- The Mercury Avator battery contains hazardous materials, which are sealed safely inside. If the Mercury Avator battery is used incorrectly, toxic liquids may leak, or gases may be released. Do not touch or ingest any of the released materials or inhale released fumes. Should inhalation, skin contact, eye contact, or swallowing occur, take the necessary first-aid measures immediately. Seek qualified emergency assistance.

BATTERY

Inhalation	Get the individual into fresh air as soon as possible and let them rest. Consult a physician immediately.
Skin contact	Remove contaminated clothing (and shoes) as quickly as possible. Rinse skin with plenty of water. Consult a physician immediately.
Eye contact	Rinse with plenty of water. Keep eyelids open for approximately 15 minutes. Remove contact lenses if possible. Continue rinsing or applying eye drops if possible. Consult a physician immediately.
Swallowing	If conscious, get the individual to rinse their mouth out with water and spit it out. DO NOT stimulate vomiting. If the individual is vomiting, keep their head down to prevent vomit from entering the lungs. Consult a physician immediately.

CORRECT DISPOSAL OF THIS PRODUCT



This product is designed and manufactured with high quality materials and components, many of which can be recycled and reused. Please be informed about the local separate collection system for electrical and electronic products. Please act according to the local rules and do not dispose of old product with normal household waste. The correct disposal of old product will help prevent potential negative consequences to the environment and human health.

Battery Disposal and Recycling

For battery disposal under warranty, contact a Mercury Marine Authorized Dealer to process the disposal through Mercury's disposal process, or be directed to dispose of it locally in accordance with regional regulations. For batteries that are being submitted for warranty through MercNET, a battery report must be generated using CDS G3. For battery disposal outside of warranty, use the following table for direction.

BATTERY

Battery Disposal and Recycling Information	
Area	Contact
Contiguous United States and Canada	Customers contact Mercury Marine Technical Service - (920) 929-5040, or the local Mercury Marine Authorized Dealer to see if local services are available. For boat builders disposing of batteries outside of warranty, contact Mercury Marine Sales - (920) 929-5838. For dealers or distributors, contact (800) 962-0927.
Europe	Mercury Marine EMEA Dealer Locator: https://www.mercurymarine.com/en/europe/find-a-dealer/ Mobile App BRUNSWICK MARINE IN EMEA LLC Parc Industriel de Petit-Rechain Avenue Mercury, 8 - 4800 Verviers, Belgium Telephone: +32 87 32 32 11
All other areas	The local government administration or recycling facility for proper disposal/recycling procedures for the specific chemistry, size, and type of the Avator battery.

Battery Management System

A battery management system (BMS) monitors battery parameters such as temperature and State of Charge (SOC). Integral to the battery, the BMS monitors the battery at all times - during operation, storage, and charging. During operation of the Avator outboard, if it detects an unsafe condition such as elevated battery temperature, it will use the Guardian system to notify the operator through the display, with an audible horn, and reduce the available power. If temperatures continue to climb and reach the critical over-temperature limit, the BMS will shut the battery down. This will render the motor, display and any motor sourced 12-volt component as unusable. In the event this occurs, remove the battery from the outboard and attempt to cool it down by moving it out of sunlight and into a climate controlled area.

If the battery core temperature exceeds the critical limits during charging, the BMS will shut the battery down to prevent it from charging further and to provide the battery time to cool down. Once the battery has cooled, the BMS will reconnect the charger to continue the charging activity.

BATTERY

Battery Connector

IMPORTANT: To prevent damage to the battery connectors of the outboard, use the weather cap to cover the terminals when the battery is removed from the outboard.



76173

Battery Charger Selection

The 7.5e Avator outboard comes with a 110-watt battery charger. The 110-watt charger has an estimated charge time of nine hours on a depleted 1 kWh battery.

An optional 230-watt battery charger is available for faster charging times. The 230-watt charger is estimated to charge a depleted 1 kWh battery in four hours.

Estimated charge times are calculated based on charging a depleted battery to fully charged, in ambient temperature range between 0-30 °C (32-89.6 °F).

Charging the Battery

IMPORTANT: Do not charge the battery near flammable liquids or materials, near direct or indirect heat sources, or in direct sunlight.

IMPORTANT: While charging, if the battery core temperature reaches 45 °C (113 °F) the battery management system (BMS) will discontinue charging the battery until the battery temperature is reduced. Allow the battery to cool down before charging the battery. Battery charging may be delayed, but will resume charging when the battery temperature has reduced.

1. Power off the outboard.
2. Remove the battery from the outboard. Refer to **Battery Removal**.
3. Install the weather cap over the battery connector terminals of the outboard.

BATTERY

NOTE: If recently used, allow the battery to cool down for at least 20 minutes before connecting it to the charger.

4. Connect the output cable of the battery charger to the Avator battery.
5. Connect the AC power plug of the charger to a 100V~240V wall outlet.

NOTE: Mercury Marine does not recommend leaving the battery on the charger unattended. If the battery is left on the charger beyond the fully charged state, the battery may be slightly below a full charge when the operator removes it from the charger.

Battery Care

IMPORTANT: There are two considerations when storing the battery that will void the warranty if exceeded:

1. **Temperature of the storage space.** Storage temperatures exceeding 60 °C (140 °F) will void the battery's limited warranty.
2. **The state of the charge (SOC) of the battery during the storage period.** Allowing the battery to deplete to a 0% state of charge (SOC) during storage for 30 consecutive days can void the battery's limited warranty.

STORAGE INSTRUCTIONS

1. Always charge the battery to a fully charged state before placing it in storage.
2. If the battery will be placed in storage longer than six months, fully charge the battery every six months.
3. Never attempt to charge a visually damaged battery.
4. Never attempt to charge a swollen battery, a battery that is venting smoke or foul smelling vapors, or a battery that feels hot to the touch.
5. If the battery displays a permanent error based on the battery LED indicators, refer to **Battery Faults**. Contact the local service center and do not attempt to charge the battery.
6. Do not store or charge the battery next to flammable materials or liquids or inside automotive vehicles.

CAUTION

Storing or charging the battery in areas where temperatures will exceed 60 °C (140 °F) will cause permanent battery damage and elevates the risk of a battery fire that could spread to surrounding materials or structures and lead to injuries or loss of life. Do not store the battery in an area where temperatures will exceed 60 °C (140 °F).

BATTERY

▲ CAUTION

Avoid hazards from possible battery fire. Batteries that have been compromised by water intrusion or other means are potentially susceptible to combustion. If a battery is suspected of having been compromised, contact a Mercury Marine Authorized Dealer as soon as possible. Do not store the affected battery indoors, in a vehicle, or near any flammable materials.

IMPORTANT: A battery is assumed to have been compromised if any of the following apply:

- Battery has been submerged.
- Internal battery components have been exposed to water.
- Battery has been dropped from a height greater than 1 m (3.28 ft).
- Battery has external damage to the case or is pierced.
- Battery has been recalled for a risk of combustion.
- Battery is not functional (excluding batteries that are end-of-life or have discharged completely).
- Battery external surfaces are hotter than 60 °C (140 °F).
- Battery appears swollen or will not fit inside of the outboard cavity.
- Battery is venting foul smelling gas, vapors, or smoke.

Battery Storage, Usage, and Charging Temperature Ranges

Battery Temperature Ranges		
Charging temperature range		0-45 °C (32-113 °F)
Operating temperature range		0-45 °C (32-113 °F)
Battery storage temperature ranges	One month	0-60 °C (32-140 °F)
	Three months	0-45 °C (32-113 °F)
	One year	0-25 °C (32-77 °F)

*Storing the battery above or below the temperature limits and intervals stated above will result in permanent reduced performance and range of the battery.

IMPORTANT: As storage periods increase in length, the temperature range of storage specification is narrowed. If temperatures are exceeded for the times shown, battery capacity will be reduced. Battery damage from improper storage is not covered under the Mercury Marine Limited Warranty for the battery.

BATTERY

Battery State of Charge (SOC) Status

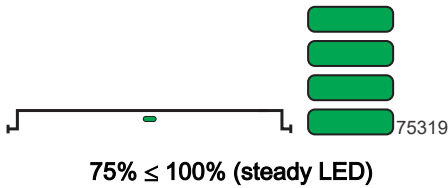
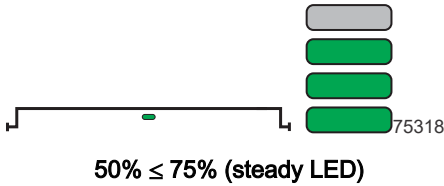
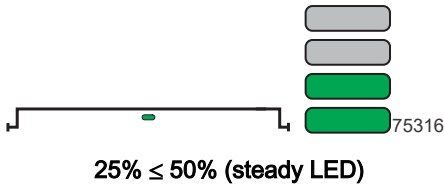
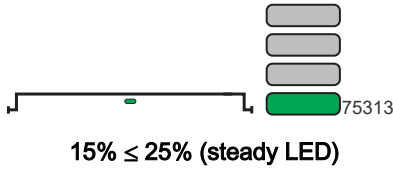
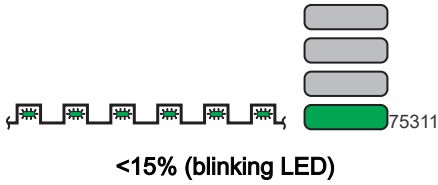

BATTERY

Battery Charging Status

While the battery is charging, the LEDs are always illuminated. The LEDs will power off after charging has completed. The charger will power off after a short length of time due to regulations.

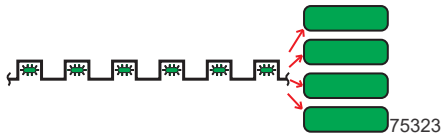

<25% (blinking LED)

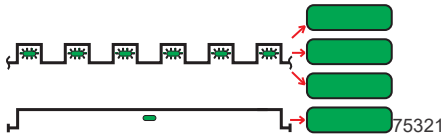

25% ≤ 50% (blinking or steady LED)

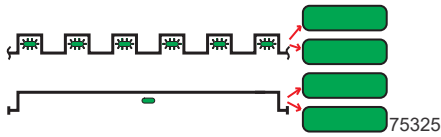

50% ≤ 75% (blinking or steady LED)

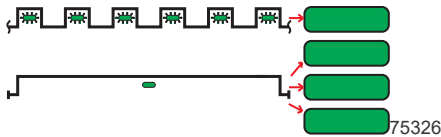

75% ≤ 100% (blinking or steady LED)

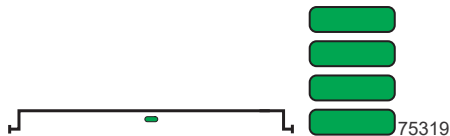

100% (steady LED)

BATTERY

Battery Faults

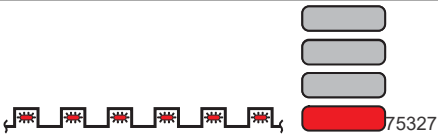
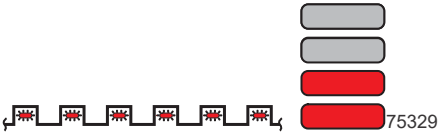
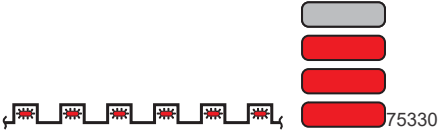
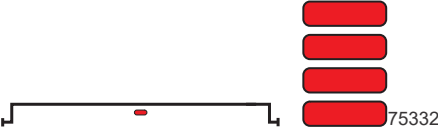
Fault	Action
<p data-bbox="86 237 368 264">Low SOC – Empty battery</p>  <p data-bbox="253 427 391 451">Blinking LED</p>	<p data-bbox="602 337 811 365">Charge the battery.</p>
<p data-bbox="86 480 375 508">Over or under temperature</p>  <p data-bbox="253 670 391 695">Blinking LED</p>	<p data-bbox="602 553 910 634">Move the battery to a -15-45 °C (5-113 °F) temperature location.</p>
<p data-bbox="86 724 348 751">Overcurrent/short circuit</p>  <p data-bbox="253 914 391 938">Blinking LED</p>	<p data-bbox="602 781 902 894">Make sure the battery is connected to a Mercury-approved charging device.</p>
<p data-bbox="86 967 267 995">Permanent error</p>  <p data-bbox="253 1157 391 1182">Steady LED</p>	<p data-bbox="602 1036 918 1117">Contact an authorized dealer for service. Do not attempt to use or charge the battery.</p>

Battery Installation

IMPORTANT: Never install a battery when the body or casing appears to be swollen.

Never install a battery that is venting smoke or foul smelling vapors.

Never install a battery that feels hot to the touch.

BATTERY

NOTICE

Battery damage can be caused by incorrectly installing the battery or connecting the battery wiring incorrectly. Do not step, lean on, or place any objects on the battery. Always install the battery with the handle and LED indicators facing upward.

1. Slide the latch to open the hood.

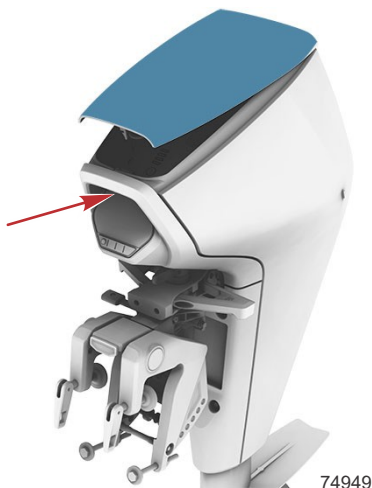

2. Verify the connector weather cap is removed from the battery connector and stowed on the hood.
3. Slide the battery into the outboard along the guide rails.

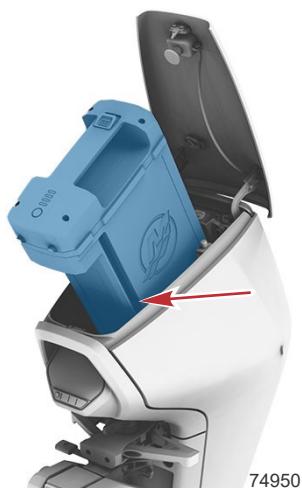

BATTERY

4. Verify the battery is secure in the outboard.

NOTE: The battery will lock into place when the battery is fully seated in the outboard.



5. Close the hood of the outboard.

NOTE: The hood will lock when it is closed.



BATTERY

NOTE: The outboard is ready to be powered on.

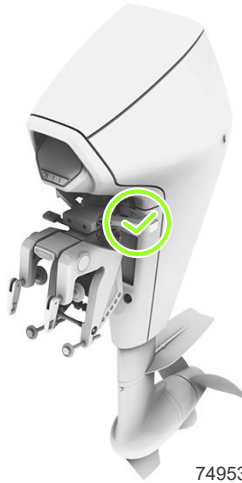

74953

Battery Removal

IMPORTANT: Removing the battery from the battery compartment disconnects power to the outboard. Do not remove the battery from the outboard with the outboard turned on, or when the boat is underway.

1. Slide the latch to open the hood.

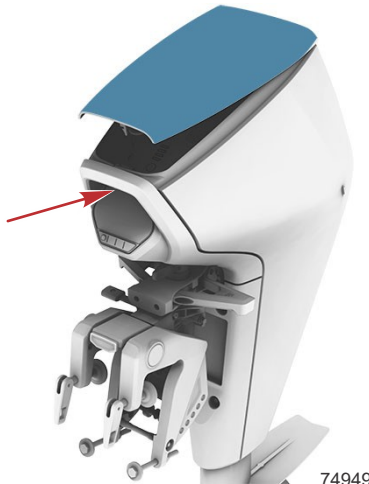

74949

BATTERY

2. Slide the lock to unlock the battery.

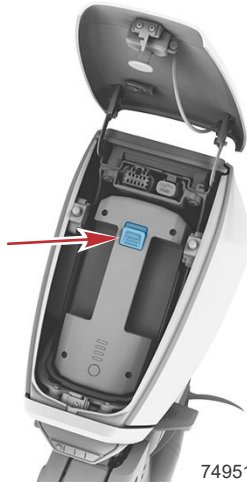

74951

3. Pull the battery out of the outboard along the guide rails.

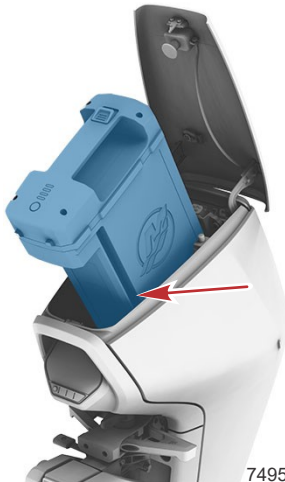

74950

BATTERY

4. Install the connector weather cap on the battery connector inside the hood.



76173

5. Close the hood of the outboard.

NOTE: *The hood will lock when it is closed.*



74952

Battery Storage Preparation

Outboard and battery storage preparation is important:

- To protect the battery from discharge during the storage period.
- To prevent the battery from going beyond the temperature ranges. Refer to **Battery Storage, Usage, and Charging Temperature Ranges**.

BATTERY

- To verify that the storage area does not expose the battery or outboard to moisture.

The following storage procedures should be followed to prepare the outboard for prolonged storage (two months or longer).

IMPORTANT: Extended storage periods of one year or longer without using the battery will result in a permanent loss of capacity of the battery.

During any period of storage, the battery must maintain a state of charge above 30 percent. If the battery is stored at a depleted SOC (less than 5%) for a period of 30 days, this is detrimental to the battery and is considered abusive. The battery monitoring system (BMS) monitors storage and charging practices. Mercury Marine requests this data when a battery is submitted for a warranty claim. Abusive storage practices can cause the battery warranty claim to be rejected.

- For periods of storage less than six months - charge the battery prior to placing it in storage.
- For periods of storage beyond six months - charge the battery every six months.
- Store the battery in a dry, well ventilated space, on cement or ceramic tile, away from flammables.

Battery Storage

The Avator Battery Management System (BMS) monitors the storage period and records parameters such as temperature and state of charge while in storage. Two of those monitored parameters can void the Mercury Marine limited battery warranty if the following limits are exceeded:

- Temperature of the storage space. Storage temperatures exceeding 60 °C (140 °F) will void the battery's limited warranty.
 - The state of the charge of the battery during the storage period. Allowing the the battery to deplete to a 0% state of charge during storage for 30 consecutive days will void the battery's limited warranty.
1. Review the **Safety Instructions** in the **Battery** section before storing the battery.
 2. Remove the battery from the outboard. Refer to **Battery Removal**.
 3. Charge the battery. Refer to **Charging the Battery**.

IMPORTANT: Battery terminals must be clean and free of corrosion.

4. Dedicate a **Lithium-ion battery only** storage area.

NOTE: *The service life of the battery can be prolonged by avoiding exposure to direct sunlight and high ambient temperatures.*

- a. Keep the ambient room temperature stable, between 0-25 °C (32-77 °F).

BATTERY

NOTICE

Damage can result to a battery exposed to temperatures above 60 °C (140 °F). Always keep the battery away from heat sources. Do not store flammable objects near the battery.

- b. Remove any direct heat sources from the designated storage area.
- c. Choose a well-ventilated and dry storage location, so the battery cannot be flooded.
- d. Remove all combustible materials from the designated battery storage area.

NOTE: *Wood, plastic, carpet, and gasoline are prohibited. Ceramic or cement surfaces are recommended storage surfaces.*

- e. Store the battery near a class ABC fire extinguisher.

BATTERY

Notes:

INSTALLATION

Installation Information

SELECTING ACCESSORIES FOR THE OUTBOARD

Genuine Avator Accessories have been specifically designed and tested for Mercury Avator outboards. These accessories are available from Mercury Marine dealers, distributors and may be available directly from Mercury Marine. Make sure to download the Avator app to an Apple or Android device for specials, discounts, and rebates regarding all Avator accessories.

IMPORTANT: Check with the local dealer before installing accessories. The misuse of approved accessories or the use of unapproved accessories can damage the product.

Some accessories not manufactured or sold by Mercury Marine are not designed to be safely used with the Avator outboard or Avator outboard operating system. Acquire and read the installation, operation and maintenance manuals for all the selected accessories.

INSTALLATION

MERCURY MARINE VALIDATED MOTOR MOUNTING HARDWARE

IMPORTANT: Mercury Marine provides validated fasteners and installation instructions, including torque specifications, with all of Mercury outboards so they can be properly secured to boat transoms. Improper installation of the outboard can cause performance and reliability issues that can lead to safety concerns. Follow all of the instructions relating to the outboard installation. **DO NOT** mount any other accessory onto the boat with the fasteners provided with the outboard. For example, do not mount TowSport bars or boarding ladders onto the boat using the mounting hardware included with the outboard. Installing other products onto the boat that utilize the outboard mounting hardware will compromise the ability of that hardware to properly and safely secure the outboard to the transom.

Outboards that require validated mounting hardware will have the following decal on the transom clamp.



75272

Installing the Outboard

INSTALLATION SPECIFICATIONS

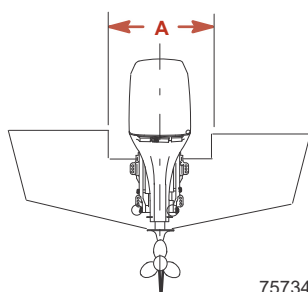

75734

a - Minimum transom opening

INSTALLATION

Minimum Transom Opening	
Single outboard (remote control models)	48.3 cm (19 in.)
Single outboard (tiller handle models)	76.2 cm (30 in.)

Transom thickness range	
Minimum	4.45 cm (1.75 in.)
Maximum	6.35 cm (2.5 in.)

INSTALLING THE OUTBOARD ON THE BOAT TRANSOM (TILLER AND REMOTE CONTROL MODELS)

⚠ WARNING

Failure to correctly fasten the outboard could result in the outboard propelling off the boat transom resulting in property damage, serious injury, or death. Before operation, the outboard must be correctly installed with the required mounting hardware.

IMPORTANT: Determine the strength of the boat transom. The outboard mounting fasteners should be able to hold 13.6 Nm (10 lb-ft) of torque.

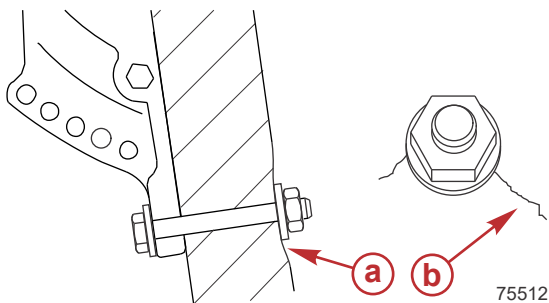

- a** - Transom yielding under excessive fastener torque
- b** - Transom cracking under excessive fastener torque

INSTALLATION

This product must be secured to the transom with the required mounting hardware. If the outboard strikes an underwater object, the required mounting hardware prevents the outboard from propelling off the transom. A decal on the swivel bracket reminds the installer of the potential hazard.



75272

IMPORTANT: Do not use the transom assembly of the outboard to guide the drill. Use the included template to mark the holes. If a drill fixture is required, use the drill fixture specific to Avator 7.5e.

1. Place the template or drill fixture on the boat's transom, paying special attention to the centerline guide and the folded top of the template.
2. With the transom template, part number 8M0182092, mark where the lower 9 mm (3/8 in.) holes in the boat's transom will be drilled.

INSTALLATION

- Use a 9 mm (3/8 in.) drill bit to drill the two lower holes through the transom.

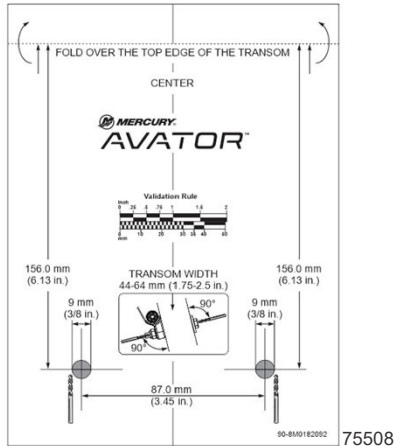

IMPORTANT: Do not apply marine sealant to the threads of the bolts.

- Apply marine sealant (obtain locally) to the shanks of the bolts.
- Remove the battery from the outboard. Refer to **Battery Removal**.
- Tiller models only - Use the quick-release to separate the transom clamp bracket assembly from the swivel bracket. Refer to **Quick-Release - Tiller Models Only**.
- Tiller models only - Install the transom bracket on the boat with the included mounting bolts.
- Remote control models only - Install the transom bracket and the outboard on the boat with the included mounting bolts.

IMPORTANT: Do not tighten the thumbscrews before tightening the lower through-transom bolts. This may result in damage to the transom or boat.

- All models - Tighten the mounting bolts to the specified torque.

Description	Nm	lb-in.	lb-ft
Fasteners	13.6	120	10

INSTALLATION

10. All models - Tighten the thumbscrews securely.

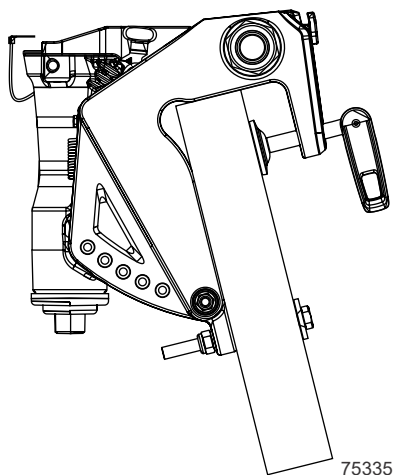

11. Verify that the outboard anti-ventilation plate is in line or up to 25 mm (1 in.) below the bottom of the boat.

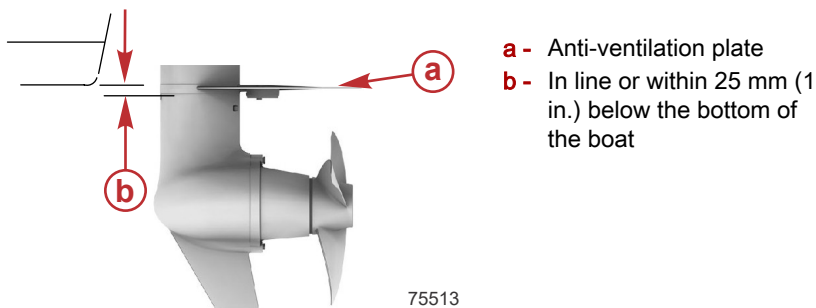

Quick-Release - Tiller Models Only

USING THE QUICK-RELEASE - TILLER MODELS ONLY

To aid in installation, use the quick-release to separate the transom clamp bracket assembly from the swivel bracket.

IMPORTANT: The tiller handle must be locked in the operating position or the folded-up position.

1. Remove the battery from the outboard. Refer to **Battery Removal**.
2. Pull the slide until the slide stops moving.

INSTALLATION

NOTE: Once the slide has cleared the probe assembly the outboard will be lifted by the quick-release spring. Or, if not installed yet, the transom bracket will be moved down and can be removed from the outboard for mounting.



INSTALLING THE OUTBOARD INTO THE QUICK-RELEASE RECEIVER - TILLER MODELS ONLY

IMPORTANT: Only perform this procedure with the transom bracket mounted to the boat.

1. Remove the battery from the outboard. Refer to **Battery Removal**.
2. Lift the outboard above the transom bracket and align the probe shaft assembly with the quick-release receiver.
3. Install the outboard by firmly pushing it down, until the probe shaft goes all the way to the bottom of the quick-release receiver.
4. Verify the outboard is locked into the quick-release receiver.

INSTALLATION

NOTE: The forward-facing edge of the slide should be even with the transom bracket.



75507

5. Attempt to lift up on the outboard to verify proper quick-release locking was established.

QUICK-RELEASE DISABLE SCREW – TILLER MODELS ONLY

This is a method to disable the quick-release mechanism from operating. This provides a more permanent installation where portability is not required. This method may discourage theft of the outboard.

NOTE: The screw and the Torx® tool will be in the literature parts bag included with the outboard.

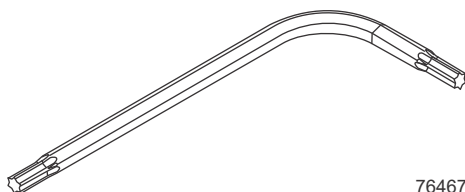

76467

1. Locate the Torx screw hole on the transom bracket.
2. With the outboard fully installed into the transom bracket, install the Torx screw into the outboard.
3. Tighten the Torx screw to the specified torque.

INSTALLATION

Description	Nm	lb-in.	lb-ft
Torx screw	1.5	13.3	–



4. Verify the quick-release is disabled by pulling the slide and attempting to lift the outboard.



Lifting the Outboard

IMPORTANT: Never lift the outboard using the battery handle while the battery is installed in the outboard. Injury or product damage/loss could result.

1. Remove the battery from the outboard. Refer to **Battery Removal**.

INSTALLATION

IMPORTANT: The tiller handle must be locked in the operating position or the folded-up position.

- When lifting the outboard, grip it from two of the following:
 - Tiller handle
 - Hand-hold on the upper portion of the rear cowling
 - Under the tiller arm assembly
 - On the lower portion of the outboard at the drive extension housing

Remote Control Steering Cable Connections

STEERING BRACKET, STEERING CABLE INSTALLATION

- Remove the shipping bracket from the steering bracket arm.
- Install the steering arm on the steering bracket with two washers and two 30 x 80 mm screws. Tighten the screws to the specified torque.

Description	Nm	lb-in.	lb-ft
Screws	30	-	22

- Lubricate the entire steering cable end with 2-4-C with PTFE.

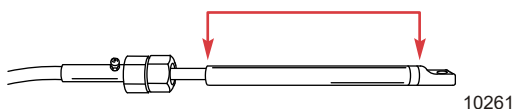

Description	Where Used	Part No.
2-4-C with PTFE	Steering cable end	92-802859A 1

- Install the steering cable seal onto the end of the steering assembly.
- Insert the steering cable into the steering tube and secure with the steering cable nut.
- Tighten the steering cable nut to the specified torque.

INSTALLATION

Description	Nm	lb-in.	lb-ft
Steering cable nut	47.5	–	35

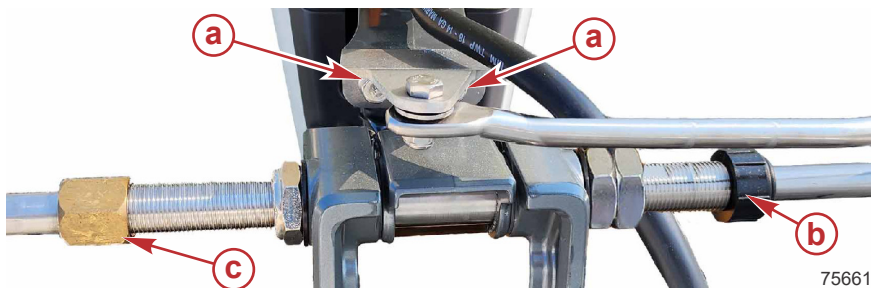

- a - Steering bracket screw and washer (2)
- b - Steering cable seal
- c - Steering cable nut

STEERING LINK ROD INSTALLATION

⚠ WARNING

Improper fasteners or improper installation procedures can result in loosening or disengagement of the steering link rod. This can cause a sudden, unexpected loss of boat control, resulting in serious injury or death due to occupants being thrown within or out of the boat. Always use required components and follow instructions and torque procedures.

IMPORTANT: The steering link rod that connects the steering cable to the outboard must be fastened using the steering link rod fastening hardware included with the outboard. Never replace the locknuts with non-locking nuts. Non-locking nuts may loosen and vibrate off, allowing the link rod to disengage.

INSTALLATION

1. Install the steering link rod onto the steering bracket threaded hole with the link rod screw, two washers, spacer, and a locknut. Do not tighten the link rod screw or the locknut.

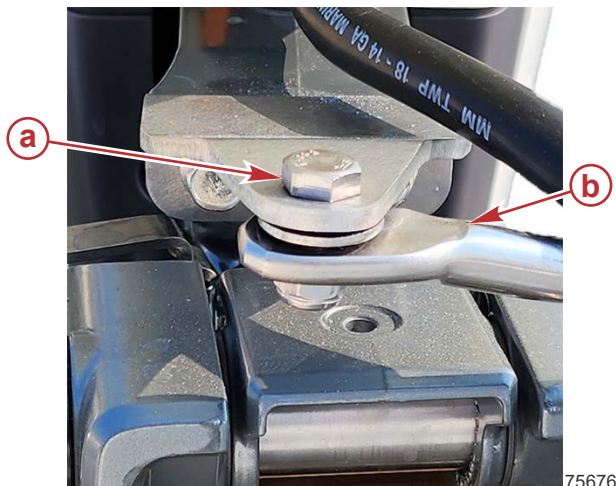

- a** - Screw
- b** - Steering link rod

2. Install the loose end of the steering link onto the steering cable and secure with a washer and locknut. Tighten the locknut securely and then back the nut off 1/4 turn.

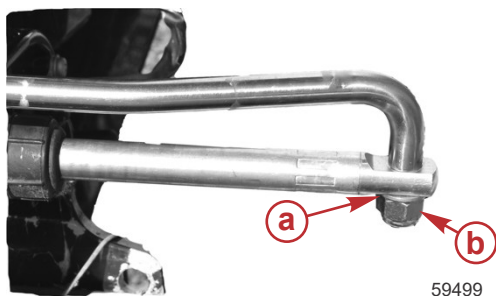

- a** - Washer
- b** - Locknut

INSTALLATION

3. Tighten the link rod screw to the specified torque.

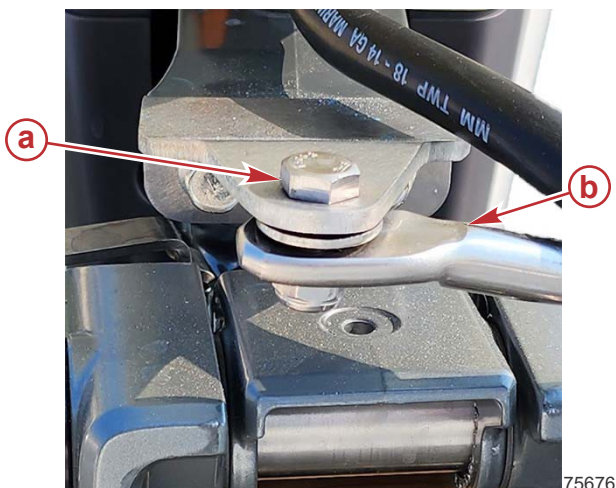

- a - Screw
- b - Steering link rod

Description	Nm	lb-in.	lb-ft
Link rod screw	27.1	–	20
Locknut	27.1	–	20

Cowl Replacement

COWL REMOVAL AND INSTALLATION PREREQUISITES

IMPORTANT: The battery must be removed before any cowl panels are removed or installed.

⚠ CAUTION

Electrical shorted circuits can cause severe physical injuries or death from burns or electrical shock. Always put down tools and metal objects, and remove any metal jewelry or wristwatches before removing cowls. Electrical wiring connections should not be removed except by an Authorized Mercury Marine Dealer.

IMPORTANT: Mercury Marine strongly recommends that a trained and certified technician perform tasks that require the cowl to be removed.

The cowl panels must be removed in the following sequence: (The port and rear cowl panels may not need to be removed for some procedures).

1. Front cowl upper panel
2. Front cowl lower panel

INSTALLATION

3. Starboard cowl panel
4. Port cowl panel
5. Rear cowl upper panel

The cowl panels must be installed in the following sequence: (The port and rear cowl panels may not need to be installed for some procedures).

1. Rear cowl upper panel
2. Port cowl panel
3. Starboard cowl panel
4. Front cowl lower panel
5. Front cowl upper panel

FRONT COWL UPPER PANEL REMOVAL

1. Remove the battery. Refer to **Battery Removal**.
2. Remove the four short hex head screws from the front cowl upper panel.



Tiller model shown, other models similar.

- a - Short hex head screws (4)
- b - Front cowl upper panel

3. Remove the front cowl upper panel from the outboard.

INSTALLATION

4. **Tiller models only:** disconnect the connector from the front cowl upper panel.



FRONT COWL LOWER PANEL REMOVAL

1. Remove the four short hex head screws and the front cowl lower panel from the outboard.



- a - Short hex head screws (4)
- b - Front cowl lower panel

INSTALLATION

STARBOARD COWL PANEL REMOVAL

1. Remove the screw from the starboard cowl panel.



76046

2. Remove the top short torx screw and the bottom torx long screw from the starboard cowl panel.

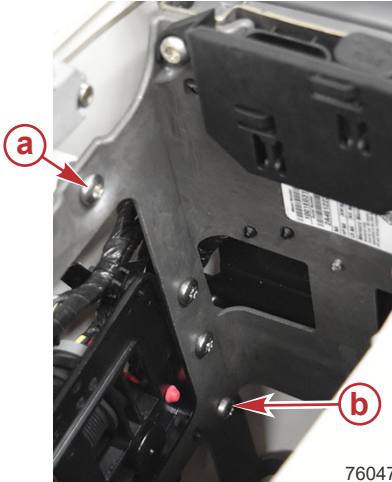

a - Top screw

b - Bottom torx long screw

76047

INSTALLATION

3. Remove the five hex head screws and the starboard cowl panel from the outboard.



- a - Starboard cowl panel
- b - Hex head screws (5)

STARBOARD COWL PANEL INSTALLATION

1. Align the starboard cowl panel pin with the outboard pin hole.

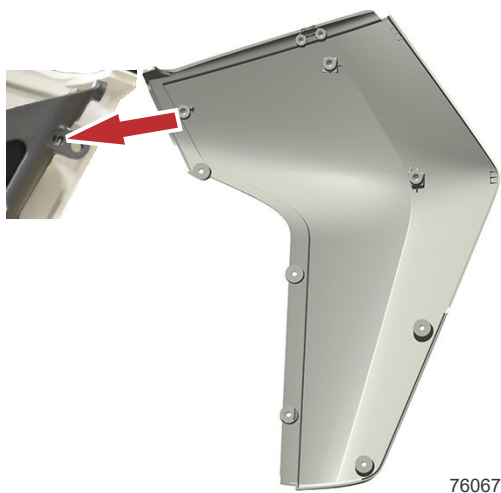

2. Install the starboard cowl panel on the outboard with the five hex head screws.

INSTALLATION

IMPORTANT: Make sure that any wiring harnesses are not pinched between the screws and the outboard.



- a** - Starboard cowl panel
- b** - Hex head screws (5)

76051

3. Tighten the screws to the specified torque.

Description	Nm	lb-in.	lb-ft
Screws	3.3	29	–

4. Secure the starboard cowl panel on the outboard with the top short torx and the bottom long torx screw.

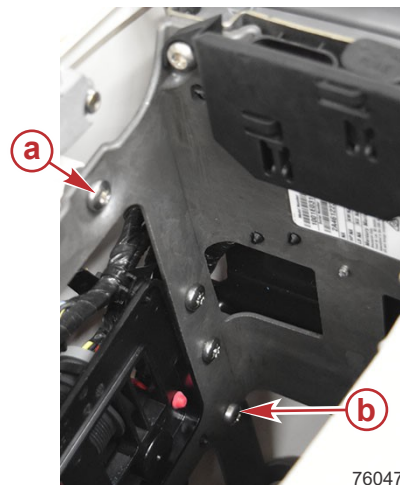

- a** - Top short torx screw
- b** - Bottom long torx screw

76047

5. Tighten the top short torx screw and the bottom long torx screw to the specified torque.

INSTALLATION

Description	Nm	lb-in.	lb-ft
Top short torx screw and the bottom long torx screw	3.3	29	–

6. Secure the starboard cowl panel to the outboard with the screw.



76046

7. Tighten the screw to the specified torque.

Description	Nm	lb-in.	lb-ft
Screw	3.3	29	–

INSTALLATION

FRONT COWL LOWER PANEL INSTALLATION

1. Align the front cowl lower panel pins with the pin holes on the outboard.

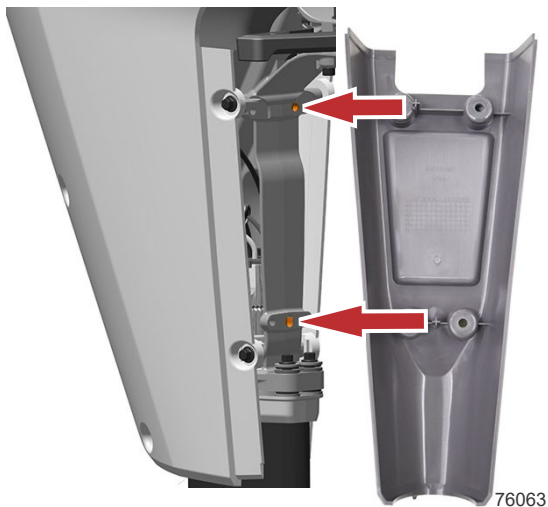

2. Install the front lower cowl on the outboard with the four short hex head screws.

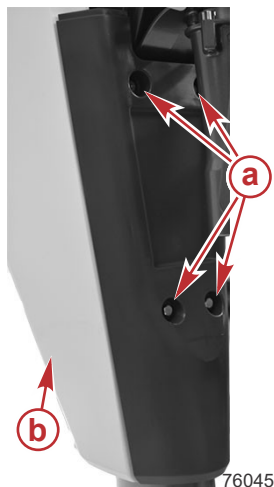

- a** - Short hex head screws (4)
- b** - Front cowl upper panel

3. Tighten the short hex head screws to the specified torque.

Description	Nm	lb-in.	lb-ft
Short hex head screws	3.3	29	–

INSTALLATION

FRONT COWL UPPER PANEL INSTALLATION

1. **Tiller models only:** connect the connector from the front cowl upper panel.



76044

2. Align the front cowl upper panel pins to the outboard.

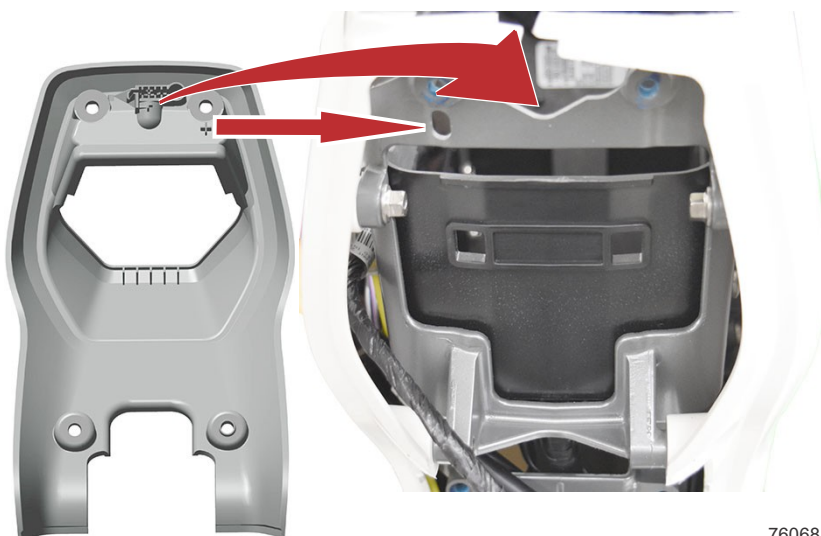

76068

Tiller model shown, other models similar.

INSTALLATION

3. Install the front cowling upper panel on the outboard with the four short hex head screws.



Tiller model shown, other models similar.

- a - Short hex head screws (4)
- b - Front cowl upper panel

4. Install the battery. Refer to **Battery Installation**.

Remote Wiring Harness Installation

1. Remove the battery from the outboard. Refer to **Battery Removal**.
2. Remove the front cowl upper panel from the outboard. Refer to **Front Cowl Upper Panel Removal**.
3. Remove the front cowl lower panel from the outboard. Refer to **Front Cowl Lower Panel Removal**.
4. Remove the starboard cowl panel from the outboard. Refer to **Starboard Cowl Panel Removal**.
5. Remove and discard the weather cap from the 14-pin data harness connection.
6. Connect the 14-pin data harness connector to the outboard harness 14-pin connector.

INSTALLATION

7. Secure the 14-pin data harness to the outboard just behind the connector with a cable tie.

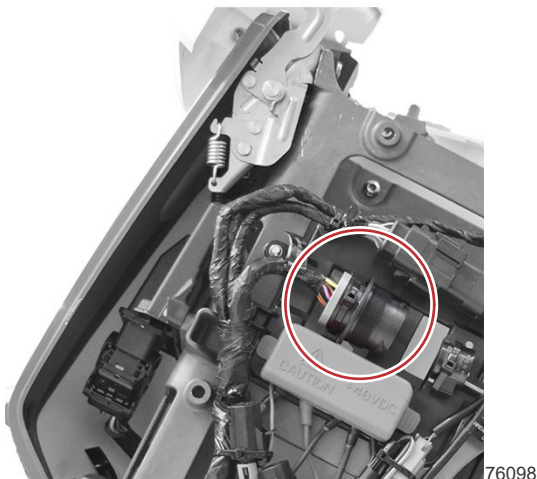

8. Verify the connectors are connected by pulling on the connections.

NOTE: The connectors should be aligned and seated flush for a proper connection.

9. Route the 14-pin data harness alongside the outboard main bracket assembly toward the front of the outboard and down and around the front of the outboard to be positioned exiting right above the steering bracket assembly.
10. Route the 14-pin harness under the steering tube assembly.



- a** - Steering assembly
- b** - 14-pin harness

INSTALLATION

NOTE: Allow harnesses to be loose near the boat transom assembly to prevent tension, binding, and chaffing in all steering ranges.

Verify that all ranges of steering are attainable without stressing, pinching, or allowing portions of the harness to gather outside of the boats transom.

11. Secure the 14-pin data harness to the boat with a cable tie.
12. Route the 14-pin data harness through the boat to the helm.
13. Secure the data harness to the boat structure anchor points using cable ties every 45.72 cm (18 in.) for proper strain relief.
14. Install the remote control in the helm or side panel. Refer to the instructions provided in the package.
15. Install the remote display either in the helm or on a pedestal mount device. Refer to the instructions provided in the package.
16. Install and connect the helm harness to the outboard, remote control, lanyard, remote display and key switch connectors. Verify the connectors are connected by pulling on the connections. Refer to the **Remote Control Architectural Diagram**.
17. Secure the harness with cable ties to the boat structure and leave at least 7.62 cm (3 in.) of loose harness to provide strain relief to the component connection points.

IMPORTANT: Failure to provide proper strain relief will eventually result in harness damage that will not be covered by the Mercury Limited Warranty provision.

18. Connect the 14-pin data harness to the helm harness.

NOTE: The connectors should be aligned and seated flush for a proper connection.

19. Verify the connectors are connected by pulling on the connections.
20. Secure the 14-pin helm harness to data harness connection to the boat structure with cable ties. Provide at least 7.62 cm (3 in.) of loose harnessing for strain relief between the two secure points.
21. Install the starboard cowl panel on the outboard. Refer to **Starboard Cowl Panel Installation**.
22. Install the front lower cowl panel on the outboard. Refer to **Front Lower Cowl Panel Installation**.
23. Install the front upper cowl panel on the outboard. Refer to **Front Upper Cowl Panel Installation**.
24. Install the battery in the outboard. Refer to **Battery Installation**.

INSTALLATION

Remote Control Diagram

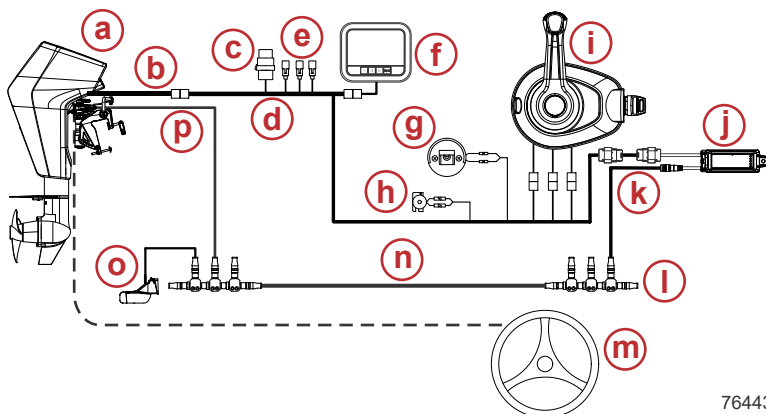

76443

- a** - Outboard motor
- b** - 14-pin harness
- c** - Power relay
- d** - Helm harness
- e** - CAN terminators
- f** - Remote display
- g** - Lanyard stop switch
- h** - Horn
- i** - Avator ERC
- j** - SmartCraft CONNECT module
- k** - NMEA 2000 cable
- l** - NMEA 2000 backbone with termination
- m** - Steering wheel
- n** - NMEA 2000 harness
- o** - Transducer
- p** - NMEA 2000 harness

INSTALLATION

Notes:

TRANSPORTING

Aquatic Invasive Species (AIS)



STOP AQUATIC HITCHHIKERS!™
Be A Good Steward. Clean. Drain. Dry.

For additional information, visit StopAquaticHitchhikers.org.

AIS and their spread can detrimentally impact the boating experience and the future of the boating lifestyle. Reducing the spread of AIS has led to significant national efforts to inspect boats moving between water bodies or across state and federal boundaries and could lead to delayed or denied access if AIS are suspected or found on board.

AIS include plant life such as Eurasian watermilfoil and water hyacinth, and animals such as spiny water flea, quagga, and zebra mussels. AIS may vary in size from microscopic, to easily visible to the naked eye, and can live in residual water or mud. These species damage ecosystems and negatively impact fishing by depleting natural food resources, altering the water environment, and changing the structure of the ecosystem.

The impact of AIS has already resulted in the limiting of boating access to many waterways throughout North America, the closure of public boat ramps, and the reduction of availability for fishing and boating across the United States. Many federal, state, and local agencies have enacted laws and regulations for inspections, permits, launch availability, and water access for boats entering public waterways.

Boats and associated equipment are major contributors to the spread of AIS. Boats that have come into contact with AIS can become a means of transportation through attachment and entrapment.

The operator should be aware that water passes in and out of the space under the lower cowls on the outboard during normal operation of the boat. When flushing and cleaning the boat to control the spread of AIS, pay attention to this space by directing flushing water into the spaces under the lower cowl.

For more information about the control of AIS in the area, please contact the area wildlife conservation office or local governmental natural resources office.

Handling the Outboard Separately From the Boat - Tiller Models Only

IMPORTANT: To avoid personal injury from accidental activation or damage to outboard or battery, remove the battery before handling, lifting, carrying, or transporting the outboard.

1. Remove the battery from the outboard. Refer to **Battery Removal**.
2. Carry the battery separately from the outboard or use the carrying case (optional accessory) to transport the battery.
3. Remove the outboard and hold it upright until the water has drained out.

TRANSPORTING

4. Use the quick release to separate the outboard from the transom bracket. Refer to **Using the Quick Release - Tiller Models Only**.
5. Fold the tiller handle to the lowest position.
6. Position the tiller lock lever to the secure locking position.
7. Use the tiller handle as a handle to carry the outboard horizontally.
8. Grip the tiller handle just behind the throttle grip.
9. Carry, transport, or store the outboard in:
 - A horizontal position, or use the carrying case (optional accessory) to carry or roll the outboard along a smooth surface.
 - On the port or starboard sides, the cowl has bumpers to help reduce damage to the cowl when the outboard is stored laying down.
 - Vertical hanging from a stand, do not rest the skeg or the propeller blades on the floor. Use the thumbscrew clamps to secure the outboard to the stand.
 - Horizontal, with the front of the outboard facing up (tiller handle folded and locked in the down position). The aft side of the cowl has a bumper to reduce damage to the cowl when the outboard is stored in this position.

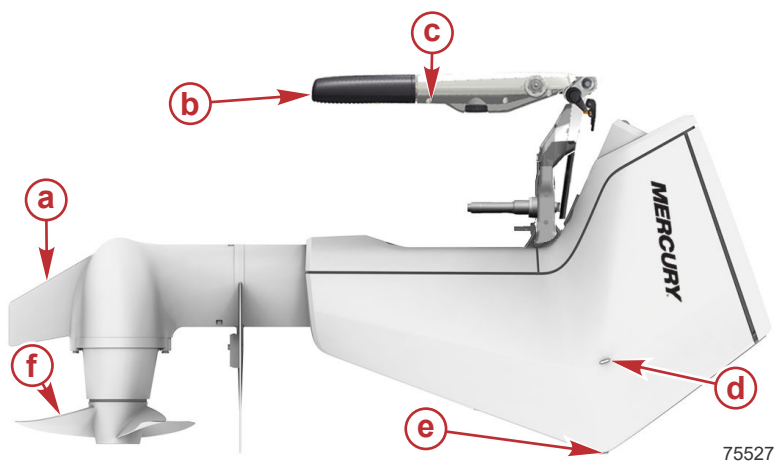

- a** - Skeg
- b** - Tiller handle
- c** - Grip tiller handle location (when carrying)
- d** - Port and starboard bumper
- e** - Aft bumper
- f** - Propeller

TRANSPORTING

Carrying Bag (Optional Accessory)



Trailer for Transportation

TRAILERING FOR TRANSPORTATION - TILLER AND REMOTE CONTROL MODELS

NOTICE

Avator remote control models and tiller models that cannot be removed from the transom require the use of an outboard support brace (commonly called a transom saver) while transporting the boat using a trailer. Severe outboard damage, vehicle or trailer damage, or complete loss of outboard while transporting could result from trailering an outboard without an outboard support brace.

The outboard support brace is included with the remote control models of Avator 7.5e outboards. If a different outboard support brace or transom saver is used, follow all instructions included with that product for safe trailering. A compatible outboard support brace will:

NOTE: *Roller style support braces are not compatible with this product.*

1. Be a bolt-on style support brace.
2. Include a bungee strap to secure the outboard into the wedge of the support brace. The bungee strap must be of proper length to secure around the outboard with no slack.

Remote control models - Must be trailered using an outboard support brace. One is supplied with the remote control Avator 7.5e outboard motor.

Tiller models:

1. Remove the battery from the outboard. Refer to **Battery Removal**.

TRANSPORTING

2. Tiller models - Use the quick-release to separate the outboard from the transom.
3. Tiller models - Place the outboard either in the towing vehicle or secure it inside the boat. Refer to **Using the Quick-Release - Tiller Models Only**, and **Lifting the Outboard**.

TRAILERING FOR TRANSPORTATION USING AN OUTBOARD SUPPORT BRACE

1. Power off the outboard.
2. Remove the battery from the outboard. Refer to **Battery Removal**.
3. Move the trim lock lever to the unlocked position.

IMPORTANT: Do not raise the outboard to the highest tilt position when trailering.

4. Take hold of the top cowl grip, and raise the outboard to an elevated trim position high enough to prevent contact with obstacles.
5. Insert and adjust the trailering support brace between the motor lower unit and the transom assembly.

IMPORTANT: Do not rely on the outboard support brace to maintain proper ground clearance for trailering. The outboard support brace is not intended to support the outboard for trailering over raised obstructions. Always be aware of terrain and obstruction heights when trailering the boat.

6. Secure the outboard support brace to the outboard with the included bungee strap.
7. Move the trim lock lever to the locked position.

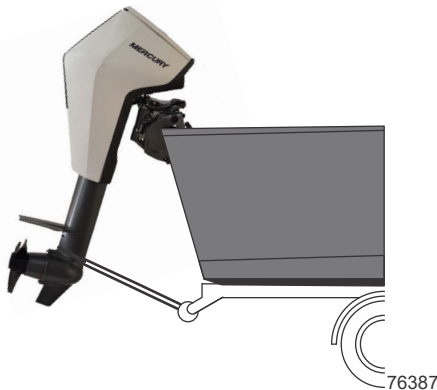

FEATURES AND CONTROLS

Tiller Handle Features

IMPORTANT: Until the operator is familiar with the characteristics and features of this tiller handle control, it is strongly suggested to initially test-operate the boat in a safe area. Use all ranges and features of the tiller handle control in an area free of swimmers or obstructions and in water deep enough to prevent beaching.

- **Throttle grip friction knob** - Turn the friction knob to set and maintain the throttle at a desired speed. Turn the knob clockwise to increase the friction, or turn the knob counterclockwise to decrease the friction.
- **Tiller handle tilt** - The tiller handle can be lowered for lifting and carrying. It can be raised to allow for outboard installation and removal.
- **Tiller lock release lever** - Push the lock release lever down to allow the tiller handle to be raised or lowered.
 - a. Lift up on the tiller handle to remove the load from the tiller lock release lever before attempting to unlock the release lever.
 - b. Rotate either of the tiller lock release levers forward to unlock the tiller.
 - c. Move the tiller to the desired position.
 - d. Rotate either of the tiller lock release levers in the aft direction to lock the tiller in place.

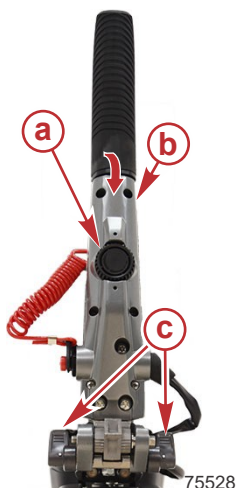

- a - Throttle grip friction knob
- b - Tiller handle
- c - Tiller handle lock release lever

FEATURES AND CONTROLS



- a** - Tiller handle lock release lever
- b** - Throttle grip friction knob
- c** - Tiller handle

- **Tiller handle yaw** - The tiller handle yaw allows the operator to change the angle of the handle 12° left or right of center. For storage, the tiller handle can be moved up to 90° left or right of center.
- **Tiller handle yaw release:**
 - a. Lift up on the tiller handle yaw release lever.
 - b. Steer the outboard all the way to a steering stop, right or left.

FEATURES AND CONTROLS

c. Adjust the position of the tiller handle, right or left.

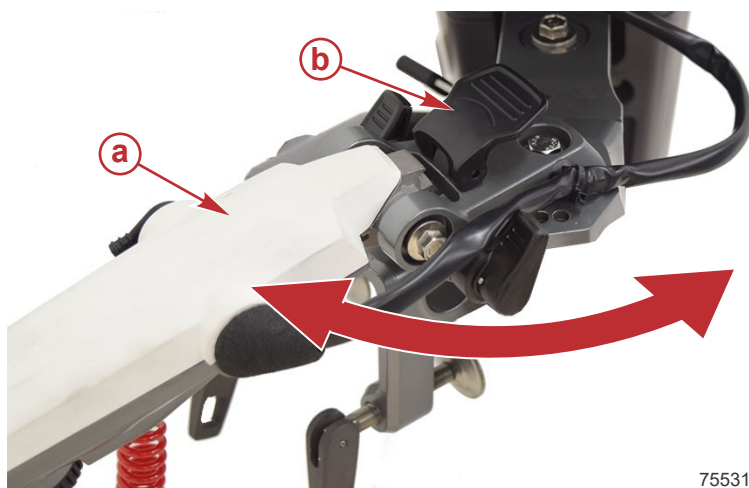

75531

Tiller handle yaw

- a** - Tiller handle
- b** - Yaw release lever

d. Disengage the yaw release and verify the lever is locked into position.

- **Lanyard stop switch** - Refer to **Lanyard Stop Switch**. A spare lanyard stop switch clip is stored on the underside of the battery compartment hood.

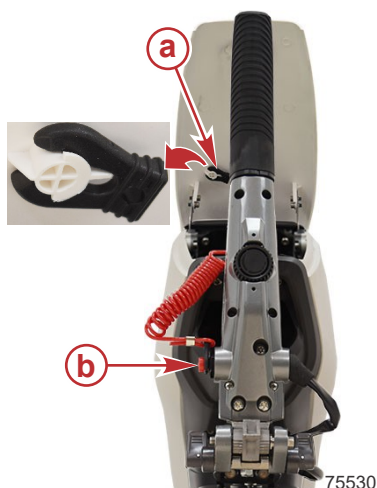

- a** - Spare lanyard stop switch clip
- b** - Lanyard stop switch

75530

FEATURES AND CONTROLS

- **Throttle grip** - Controls the outboard speed and direction of travel. Align the throttle grip with the neutral detent on the tiller handle when starting or before engaging into the forward or reverse positions. Twist the throttle grip to increase the outboard speed. Throttle direction configuration is dependent on outboard setup. Refer to **Outboard Settings - Tiller Models**.



76171

Copilot (Steering Friction Adjustment)

The copilot lever provides a steering friction adjustment for user preference.

The copilot lever is used to help hold the tiller steering lever in place with minimal operator effort if the friction level is turned to the maximum position.

- To increase friction, turn the copilot lever to the left.

FEATURES AND CONTROLS

- To decrease friction turn the copilot lever to the right.

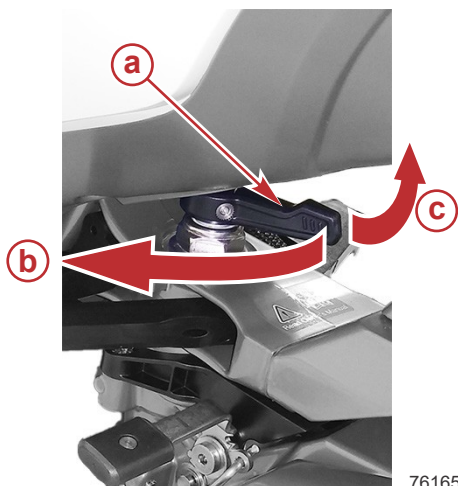

- a** - Copilot lever
- b** - Left - increase friction
- c** - Right - decrease friction

76165

Remote Control Features

IMPORTANT: Until the operator is familiar with these remote controls, it is strongly suggested to initially test-operate the boat in a safe area. Use all features and ranges of these remote controls in an area free of swimmers, obstructions and in water deep enough to prevent grounding to become familiar with the characteristics and features of these controls.

- **Neutral lock bar** - Squeeze the neutral lock bar to allow the control handle to move in forward or reverse directions. When the control handle is returned to neutral, the neutral lock bar will engage again, to prevent inadvertent travel of the remote control handle.
- **Control handle** - Starting from the neutral position, squeeze the lock bar to release the control handle.
 - a. Forward outboard control** - Push the control handle forward from neutral to the first detent.
 - b. Reverse outboard control** - Push the control handle back from neutral to the first detent.

FEATURES AND CONTROLS

IMPORTANT: Forcing the shift mechanism without squeezing the neutral lock bar can damage the remote control.



- a** - Throttle/shift lever
- b** - Neutral lock bar
- c** - Ignition key switch—**OFF, ON**

Helm-Mounted Lanyard Stop Switch

The helm-mounted lanyard stop switch shuts the outboard off when the operator moves away from the boat controls, beyond the range of the lanyard cord. Refer to **Lanyard Stop Switch**.



FEATURES AND CONTROLS

Avator Outboard Trim System

⚠ WARNING

Operating the outboard without ensuring the trim lock is engaged in a locked position can cause serious injury or death. The outboard can tilt upwards when decelerating or operating in reverse, causing loss of boat control. Always engage the trim lock of the outboard in the locked position before operating.

The Avator outboard system allows the operator to lock the outboard in five trim positions.

NOTE: For information on trailering or transporting the outboard refer to **Trailering for Transportation**.

The Avator outboard trim system should be adjusted only with the outboard powered **OFF**.

BASIC TRIMMING OPERATION

Raise the trim position:

1. Move the trim lock lever in the rearward direction to the unlocked position.
2. Push down on the tiller handle with the handle locked in either the raised position or in the horizontal position.
3. Grip the cowl hand hold and raise the outboard to the desired trim position.
4. Lock the trim lock lever into position and release the outboard.

Lower the trim position:

1. To lower trim position, move the trim lock lever to the unlocked position and turn the outboard to either full left or full right position.

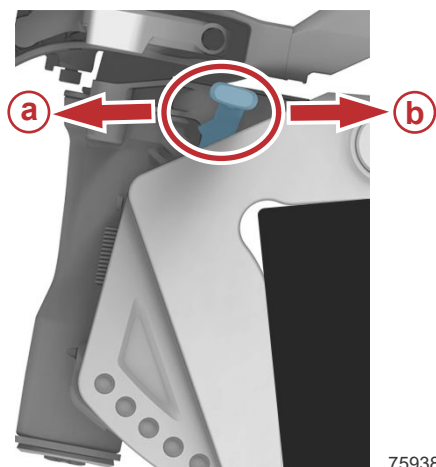

- a - Trim lock unlocked position
- b - Trim lock locked position

75938

FEATURES AND CONTROLS

2. Push down on the tiller handle with the handle locked in the raised position.
3. Grip the cowl hand hold and raise the outboard as far as it can travel.

NOTE: The outboard will be at or near the horizontal position at the uppermost travel limit.

4. Slowly let the outboard down to the lowest trim position.
5. Lock the trim lock lever into position and release the outboard.



SHALLOW WATER OPERATION

When operating the boat in shallow water, the outboard can be adjusted and locked at a higher trim angle. Operate the outboard below 8.04 kph (5 mph) while trimmed up for shallow water operation. Keep the propeller blades completely submerged in the water.

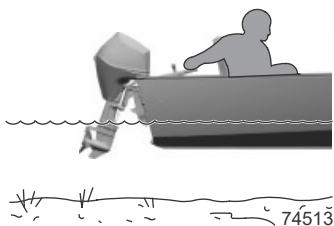

FEATURES AND CONTROLS

IMPORTANT: Before trimming the outboard into the shallow water drive position, power off the outboard.

While in the shallow water drive position, do not operate the outboard in reverse. Operate the outboard at slow speed, and keep the propeller submerged.

If beaching the boat on the shore, leave the reverse lock lever in the free or unlocked position. Do not operate the boat above 3.2 kph (2 mph) while the reverse lock is in the unlocked position.

Trim the outboard to the desired position for shallow water operation. Refer to **Basic Trimming Operation**.

OPERATING ANGLE ADJUSTMENT

The transom brackets have five trim positions for adjusting the vertical operating angle of the outboard.



75541

Adjust the vertical operating angle of the outboard so that the outboard runs perpendicular to the water when the boat is at full speed.

FEATURES AND CONTROLS

Arrange passengers and the load in the boat so the weight is distributed evenly.

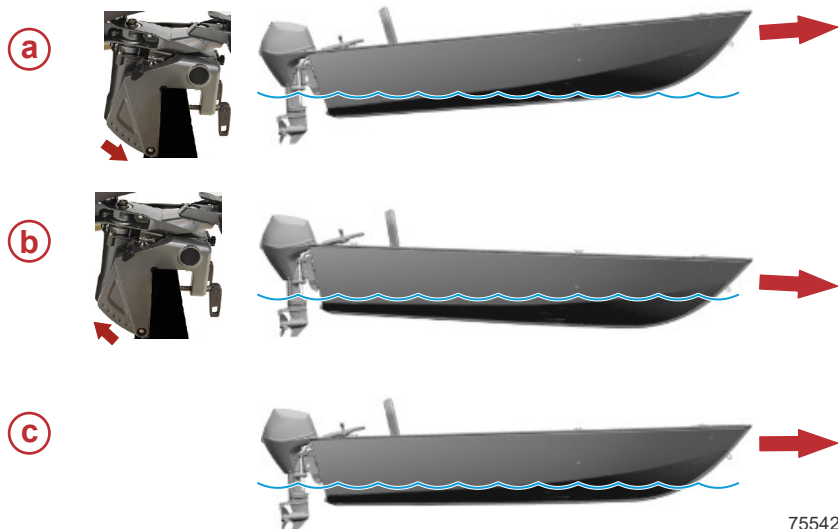

75542

- a** - Too much vertical operating angle (bow up) - adjust in
- b** - Not enough vertical operating angle (bow down) - adjust out
- c** - Vertical operating angle adjusted properly (bow slightly up)

NOTE: When docking or using reverse, the outboard should be in the trim locked position during operation.

The trim lock lever should only be in the unlocked position when beaching the boat or adjusting the trim position.

Consider the following items carefully when adjusting the operating angle of the outboard.

Adjusting the outboard close to the boat transom can:

- Lower the bow.
- Improve visibility of objects in front of the boat.
- Improve the ride in choppy water.
- Increase steering pull to the right.
- In excess, lower the bow of some boats to a point where they begin to plow with their bow in the water. This can result in an unexpected turn in either direction (called bow steering or oversteering), if any turn is attempted or if a significant wave is encountered.

Adjusting the outboard away from the boat transom can:

- Lift the bow out of the water.
- Increase top speed and range.

FEATURES AND CONTROLS

- Increase clearance over submerged objects or a shallow bottom.
- Increase steering pull to the left at a normal installation height.
- In excess, cause boat porpoising (bouncing) or propeller ventilation.
- Reduce visibility of objects in front of the boat.

Warning Horn

Remote control models will have the warning horn located under the helm.

Tiller handle models will have the warning horn located under the starboard cowl panel.

Audio Warning System

IMPORTANT: The audio warning system alerts the operator that a problem has occurred. It does not protect the outboard from damage.

Most faults cause the warning horn to activate. How the warning horn activates depends upon the severity of the fault.

There are two warning horn states:

- Caution
- Critical

A nonconfigured alarm will sound if the helm has not been properly configured using the CDS G3 service tool.

CAUTION

If a caution state is detected, the audio warning system will sound for six one-second intervals.

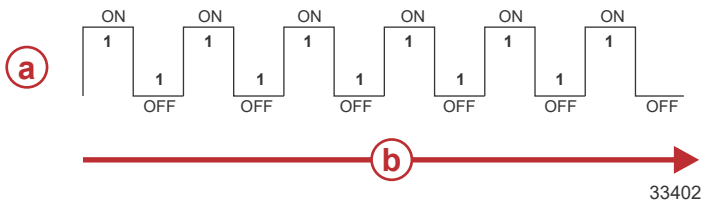

a - Horn (on or off)

b - Time (in seconds)

FEATURES AND CONTROLS

CRITICAL

If a critical state is detected, the audio warning system will sound for six seconds and then turn off.

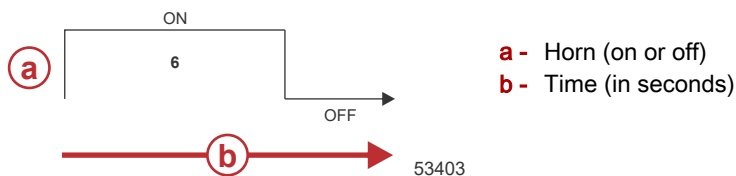

NONCONFIGURED ALARM

If the helm has not been properly configured using the CDS G3 service tool, the audio warning system will sound for five one-second intervals.

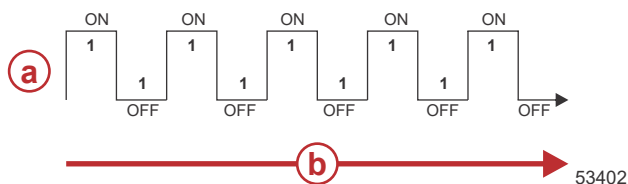



- a - Horn (on or off)
- b - Time (in seconds)

TESTING THE AUDIO WARNING SYSTEM





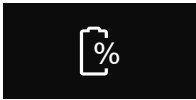

1. **Tiller models only** - press and release the power button on the display.
2. **Remote control models only** - turn the key switch to the **ON** position.
3. The alarm will sound if the system is functioning correctly.

Display Icon Legend

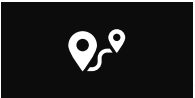

GENERAL

Icon	Description
 76104	Battery percent
 76106	Time remaining







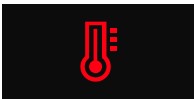

FEATURES AND CONTROLS

Icon	Description
 76108	Speed
 76109	Power (kW)
 76110	Distance remaining
 76111	Settings
 76112	Brightness
 76113	Depth
 76114	Throttle direction

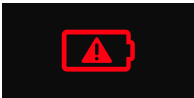
ALARM/WARNING

Icon	Description
 76115	Active fault
 76116	GPS fault

FEATURES AND CONTROLS



Icon	Description
 <p>76117</p>	Attach lanyard
 <p>76118</p>	Temperature fault
 <p>76119</p>	Propulsion fault
 <p>76120</p>	Battery fault
 <p>76121</p>	Charge icon
 <p>76122</p>	Charge text
 <p>76123</p>	Low battery icon
 <p>76124</p>	Low battery text
 <p>76125</p>	Left alarm chevron
 <p>76126</p>	Right alarm chevron

FEATURES AND CONTROLS



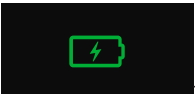

ACTIVE FEATURE

Icon	Description
 76127	Troll active







POSITIVE STATES

Icon	Description
 76128	Charge icon
 76129	Settings Saved text
 76130	Ready state (neutral)

UNITS/NUMBERS/LABELS

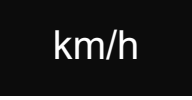
Icon	Description
 76131	Alarm text
 76137	Type in alarm type
 76138	Code in alarm code
 76139	Power (kW)

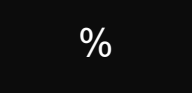
FEATURES AND CONTROLS

Icon	Description
 76140	Estimated text (estimated time to charge, estimated range)
 76141	Range text (distance to discharged)
 76143	Kilometers per hour
 76144	Miles per hour
 76146	% (percent)
 76147	Kilowatts of power
 76148	Knots

BATTERY INDICATION

Icon	Description
 76149	Battery scale

SmartCraft CONNECT Installation - Tiller Models

IMPORTANT: Mercury Marine strongly recommends that a trained and certified technician perform servicing tasks that require removing cowling, including installing the SmartCraft CONNECT.

FEATURES AND CONTROLS

NOTE: SmartCraft CONNECT is an optional accessory and must be purchased separately.

The following instructions are for installing the SmartCraft CONNECT on tiller models. The SmartCraft CONNECT must be mounted under the helm on remote control models.

SmartCraft CONNECT Serial Number

SN:

Refer to SmartCraft CONNECT quick reference guide included with the product for the link to configuration instructions online.

1. Record the serial number from the body of the SmartCraft CONNECT in the **SN:** space in the **SmartCraft CONNECT Serial Number** table above.
2. Remove the battery from the outboard. Refer to **Battery Removal**.
3. Remove the front cowl upper panel from the outboard. Refer to **Front Cowl Upper Panel Removal**.
4. Remove the front cowl lower panel from the outboard. Refer to **Front Cowl Lower Panel Removal**.
5. Remove the starboard cowl panel from the outboard. Refer to **Starboard Cowl Panel Removal**.
6. Remove and discard the weatherproof connector cover from the 10-pin data harness connection.



76053

7. Connect the 10-pin connector on the SmartCraft CONNECT to the outboard wiring harness connector.
8. Verify the connectors are connected by pulling on the connections.

NOTE: The connectors should be aligned and seated flush for a proper connection.

FEATURES AND CONTROLS

IMPORTANT: Do not secure the SmartCraft CONNECT to the main battery bracket assembly. The cable ties will interfere with the battery.

9. Install the SmartCraft CONNECT on the outboard and secure the SmartCraft CONNECT harness to the outboard with the cable ties.

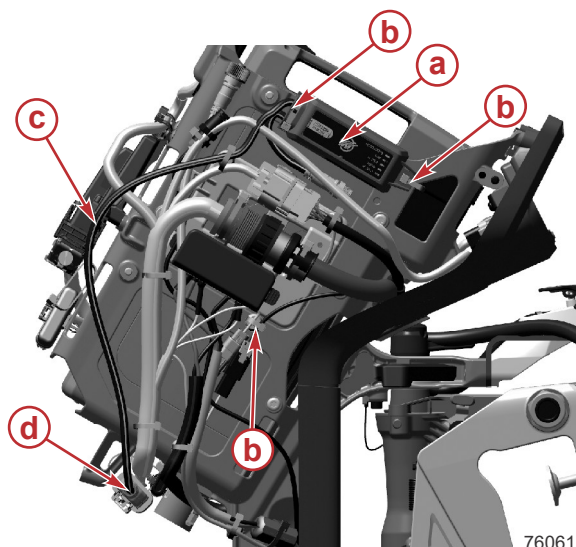

- a - SmartCraft CONNECT
- b - Cable tie
- c - SmartCraft CONNECT harness
- d - 10-pin connector

10. Install the starboard cowl panel on the outboard. Refer to **Starboard Cowl Panel Installation**.
11. Install the front lower cowl panel on the outboard. Refer to **Front Lower Cowl Panel Installation**.
12. Install the front upper cowl panel on the outboard. Refer to **Front Upper Cowl Panel Installation**.
13. Install the battery in the outboard. Refer to **Battery Installation**.

Near Field Chipset (NFC) Decal and Mercury Marine App

The under-hood label on the Avator 7.5e outboard contains an NFC that can be read by NFC-enabled smart devices.

- Android™ devices will link to the the Google Play App Store™ for downloading the Mercury Marine App.
- iOS™ devices will link to the Apple AppStore™ for downloading the Mercury Marine App.

FEATURES AND CONTROLS

- If the Mercury Marine App has already been downloaded, the phone will be prompted to open the App.

The Mercury Marine App provides useful information such as links to the Operations Manual, Quick Reference Guides, helpful tutorials, and mapping functionality. The Mercury Marine App will also provide data from the outboard/battery if the optional accessory SmartCraft CONNECT is purchased and installed.

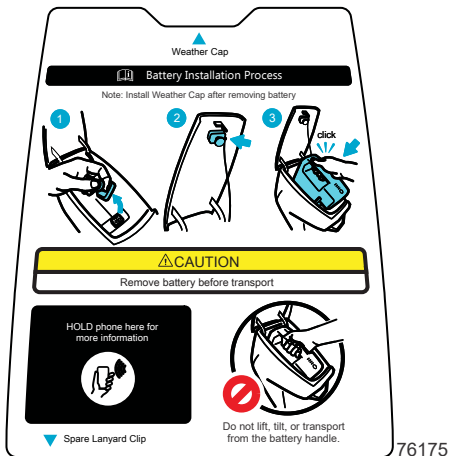

FEATURES AND CONTROLS

Notes:

OPERATION

Prestarting Check List

- The operator knows safe navigation, boating, and operating procedures.
- An approved personal flotation device of suitable size is available for each person aboard.
- A ring type life buoy or buoyant cushion designed to be thrown to a person in the water.
- Know the boat's maximum load capacity. Look at the boat capacity plate.
- Battery state of charge (SOC) should be full. Short trips require a minimum of 30% SOC before operating the outboard.
- Arrange passengers and load in the boat so the weight is distributed evenly.
- Tell someone the location and the expected return time.
- Do not operate a boat while under the influence of alcohol or drugs.
- Know the waters and area that will be traversed; tides, currents, sand bars, rocks, and other hazards.
- Make inspection checks listed in **Inspection and Maintenance Schedule**.

⚠ WARNING

Electromagnetic radiation can cause death or severe physical injuries to persons with a cardiac pacemaker or internal defibrillator device.

Anyone with a cardiac pacemaker must maintain a distance of at least 50 cm (19.7 in.) from the battery, motor, and chargers.

Prestarting Instructions

1. Verify the SOC of the battery using both the battery LED indicators and the display.
2. Verify the audible alarm is functional when the outboard is powered up.
3. Test the function of the lanyard and verify the lanyard cord is in good condition.
4. Before the lanyard is placed back in the operational position, verify that the tiller handle neutral indications are aligned (tiller handle models).

IMPORTANT: For Avator outboard tiller models, it is recommended to remove the lanyard from it's stored position prior to powering up the outboard. This will prevent unintended in-gear activation of the outboard by the operator.

5. Power up the outboard and place the lanyard back in the operational position.
6. Verify the trim lock lever is functional.
7. Check the system for active faults using the display and the battery LED indicators.
8. Use the tiller or remote control to change the gear position.

OPERATION

Powering On/Off the Outboard: Tiller Models

IMPORTANT: To stop the outboard in an emergency, pull the lanyard on the tiller handle.

1. Inspect the outboard and check the following items:
 - The battery is installed in the outboard.
 - The lanyard stop switch is attached.
 - The throttle is in the neutral position.
 - The propeller is in the water and clear of any obstructions.

IMPORTANT: It is recommended to remove the lanyard stop switch from its stored position prior to powering up the outboard. This will prevent unintended in-gear activation of the outboard by the operator. Before the lanyard is placed back in its operational position, verify that the tiller handle neutral indications are aligned. Then power up the outboard and place the lanyard back in its operational position. Use the tiller to change the gear position, forward or reverse.

2. Press the power button on the display.



74744

OPERATION

NOTE: The display will show the current battery percent.



3. To power off the outboard, press and hold the power button until the battery percent disappears.



Powering On/Off the Outboard: Remote Control Models

Inspect the outboard and check the following items:

1. The battery is installed in the outboard.
2. The lanyard stop switch is attached.

OPERATION

3. The remote control is in the neutral position.



4. The propeller is in the water and clear of any obstructions.

POWER ON

Turn the key to the **ON** position.

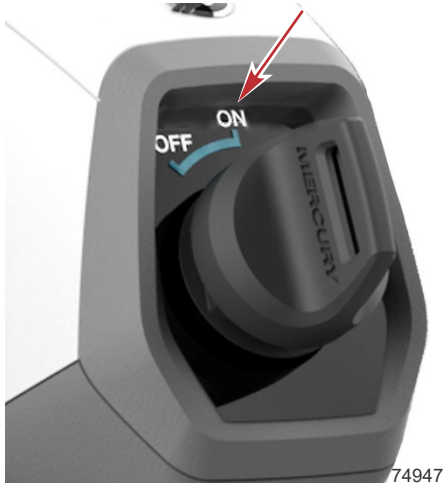

OPERATION

NOTE: If the system has a remote display, the key switch will turn the display on.



74948

POWER OFF

Turn the key to the **OFF** position.

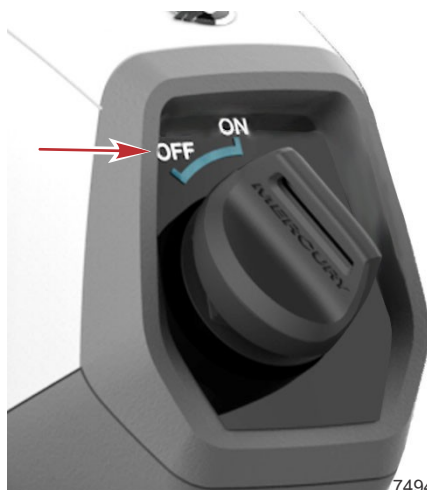

74946

Operating the outboard - Remote Control Models

Before starting, read the **Prestarting Check List** and **Prestarting Instructions** in this section.

OPERATION

1. Set the lanyard stop switch to the **RUN** position. Refer to **Lanyard Stop Switch**. Attach the lanyard to the operator.



19791

2. Verify the remote control handle is in the neutral position.



OPERATION

3. Turn the key to the **ON** position.



Key in ON position

4. Check the display that there are no active faults or conditions that may cause active faults.
5. Check the safety and positioning of passengers before operating the outboard.
6. Move the remote control lever into forward or reverse position to move the boat. Refer to **Using and Changing Directional Controls**.

Operating the outboard - Tiller Handle Models

Before starting, Refer to the **Prestarting Check List** and **Prestarting Instructions**

1. Verify the tiller handle grip is in the neutral position (lines are aligned).



- a** - Line on the tiller housing
- b** - Line on the tiller control grip

2. Press the power button on the display to power up the outboard.
3. Remove the lanyard from the stop switch on the tiller handle.
4. Install the lanyard to the stop switch and connect it to the operator.

OPERATION

5. Check the display for the E-stop fault due to lanyard activation has cleared and there are no active faults or conditions that may cause active faults.
6. Check the safety and positioning of passengers before operating the outboard.
7. Twist the tiller handle grip into forward or reverse gear position.

NOTE: Throttle direction configuration is dependent on outboard setup. Refer to **Outboard Settings - Tiller Models**.

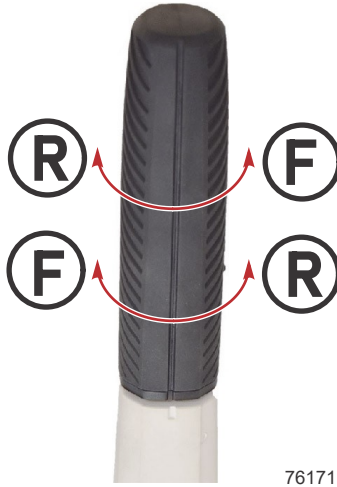

76171

Outboard Settings - Tiller Models

THROTTLE DIRECTION AND UNITS OF MEASURE SETUP

1. Press and hold the menu button for two seconds.



74746

OPERATION

NOTE: The current throttle direction set point will flash.

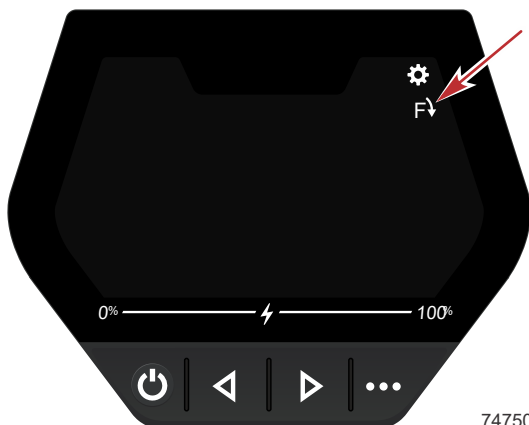

74750

2. Use the left or right arrow to select the forward direction of the tiller handle.

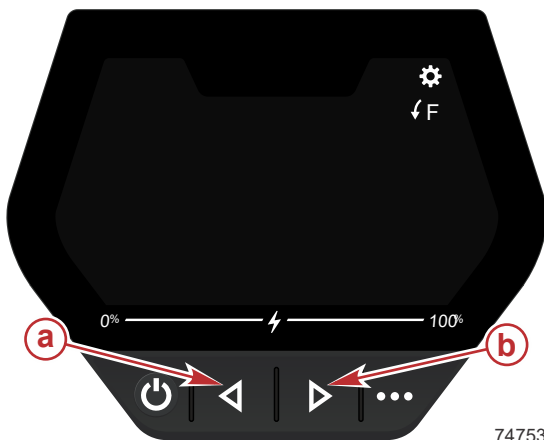

74753

- a** - Left arrow
- b** - Right arrow

OPERATION

3. Press the menu button to save the setting.



NOTE: The current unit of measure set point will flash.



OPERATION

4. Use the left or right arrow to select the type of units to be displayed.

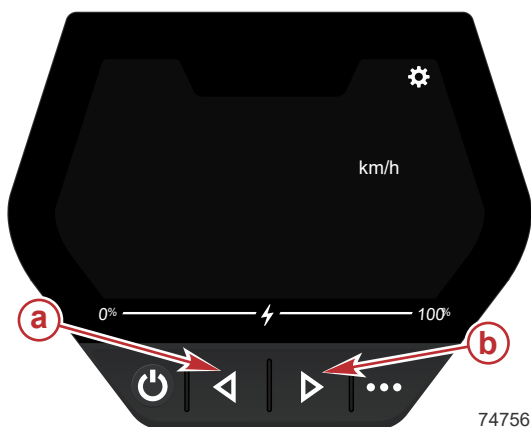

- a** - Left arrow
- b** - Right arrow

5. Press the menu button to save the setting.



NOTE: Setup is complete. The display will revert back to the main screen.

OPERATION

Outboard Settings - Remote Control Models

1. Press and hold the menu button for two seconds.



NOTE: The current unit of measure set point will flash.

2. Press the left or right arrow to select the type of units to be displayed.

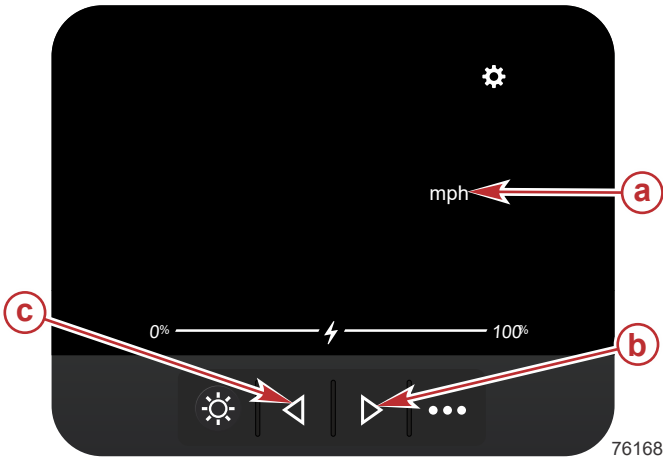

- a** - Current unit of measure
- b** - Right arrow
- c** - Left arrow

OPERATION

3. Press the menu button to save the setting.

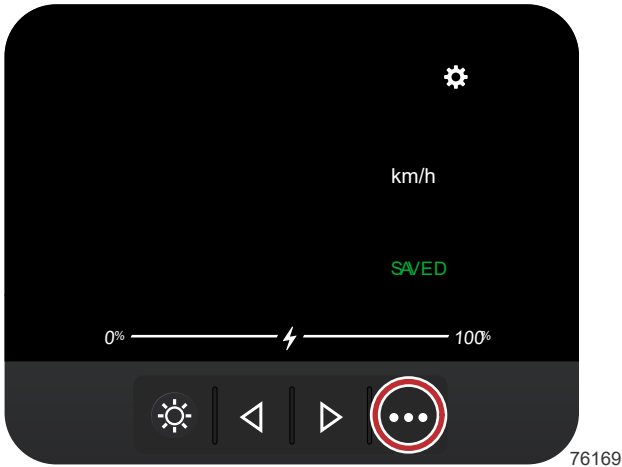

NOTE: Setup is complete. The display will revert back to the main screen.

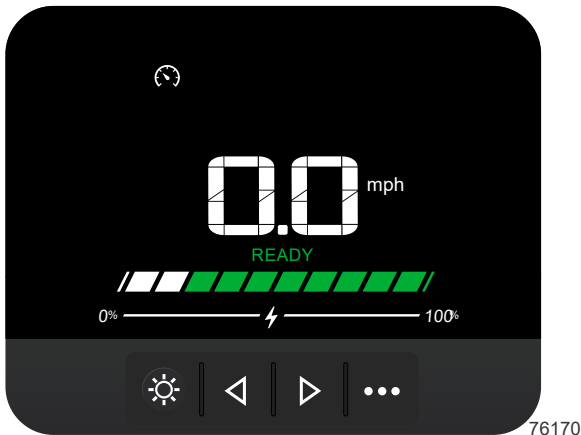

Using and Changing Directional Controls

IMPORTANT: Observe the following:

- Never change the directional control rapidly from reverse to forward without stopping at neutral to allow the propeller to stop spinning. This action could cause outboard and component damages.
- Do not change the directional control into reverse when the forward motion of the boat is greater than a no wake speed. This action could cause outboard or component damages.

OPERATION

- **Tiller handle models** - Three directional control positions provide boat operation: forward (F), neutral (N), and reverse (R). When changing directional control, always stop at the neutral position and allow the propeller to stop turning.

NOTE: Throttle direction configuration is dependent on outboard setup. Refer to **Outboard Settings - Tiller Models**.

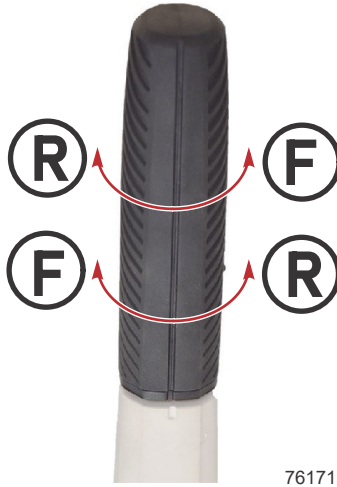

- **Remote control models** - Three directional control positions provide boat operation: forward (F), neutral (N), and reverse (R). When changing directional control position, always stop at the neutral position and allow the propeller to stop turning.

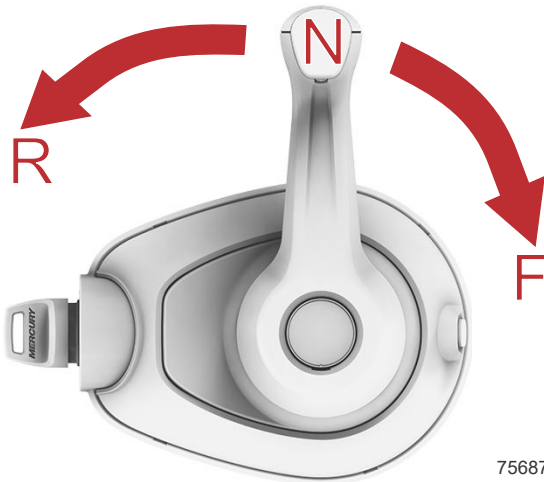

OPERATION

- After placing the directional control into forward or reverse, move the remote control lever or rotate the throttle control grip to move the boat.

Powering Down the Outboard

REMOTE CONTROL MODELS

1. Move the remote control to the neutral position and confirm that the boat has reduced speed.
2. Turn the ignition key **OFF**.

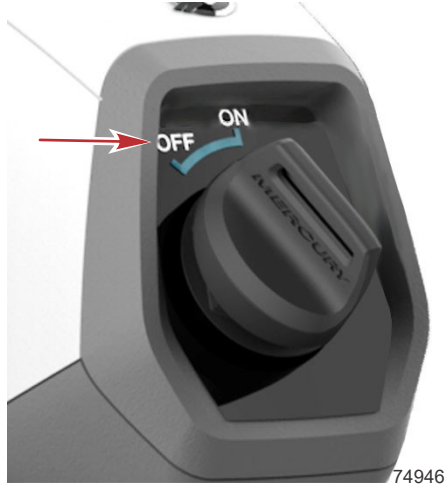

Key OFF

TILLER HANDLE MODELS

1. Change the direction of the boat by twisting the tiller handle control grip.
2. Twist the tiller handle control grip to the neutral position to stop the outboard propeller movement.



- a** - Tiller handle neutral detent
- b** - Control grip neutral detent

3. Press the power button until the display powers off.

OPERATION

4. Release the power button.



Recommended Operating Temperature Ranges for the Avator 7.5e Outboard

The Avator 7.5e outboard and battery were designed to operate in ambient air temperature ranges above 0 °C (32 °F) and below 45 °C (113 °F).

Operating above the recommended ambient air temperature limit could cause the motor or battery to overheat.

The following conditions will occur if high temperature limits are exceeded during operation:

1. An initial over-temperature warning fault will occur when the battery core temperature exceeds 53 °C (127 °F). Power output will be reduced and a non-critical horn will sound once every key switch cycle until the battery cools down.
2. If the battery temperature exceeds 60 °C (140 °F), the battery will shut down and the display and motor will be rendered non-functional until the battery temperature is reduced. Operating below the lower limit of the recommended ambient air temperature range may reduce the available power and operating ranges.

Operating in Saltwater or Polluted Water

If the boat is kept in the water, always tilt the outboard so the outboard lower motor unit is completely out of the water when not in use.

Wash the outboard exterior with fresh water after each use. Each month, spray Mercury Precision or Quicksilver Corrosion Guard on external metal surfaces. Do not spray on corrosion control anodes as this will reduce the effectiveness of the anodes.

MAINTENANCE

Cleaning Care

OUTBOARD CLEANING

To keep the outboard in the best operating condition, it is important that the outboard receive the periodic inspections and maintenance listed in the **Inspection and Maintenance Schedule**. Mercury Marine urges the operator to keep it maintained properly to ensure that the safety of the operator and the passengers, and retain its dependability.

Record maintenance performed in the **Maintenance Log**. Save all maintenance work orders and receipts.

Selecting Replacement Parts For the Outboard

Mercury Marine recommends using original Mercury Precision, Mercury Avator, or Quicksilver replacement parts.

CAUSTIC CLEANING CHEMICALS

IMPORTANT: Do not use caustic cleaning chemicals on the outboard. Some cleaning products contain strong caustic agents such as hull cleaners with hydrochloric acid. These cleaners can degrade some of the components they come in contact with including critical steering fasteners.

Damage to steering fasteners may not be obvious during visual inspection and this damage may lead to catastrophic failure. Some caustic cleaning chemicals may cause or accelerate corrosion. Exercise caution when using cleaning chemicals around the outboard and follow the recommendations on the packaging of the cleaning product.

CLEANING DISPLAY SCREENS

IMPORTANT: Never use high-pressure water to clean Avator outboards or electronic displays.

Routine cleaning of the displays is recommended to prevent a buildup of salt and other environmental debris. Crystallized salt can scratch the display screens, even when using a dry or damp cloth. Ensure that the cloth has a sufficient amount of fresh water to dissolve and remove salt or mineral deposits. Do not apply aggressive pressure on the display screen while cleaning.

When water marks cannot be removed with a damp cloth, mix a 50/50 solution of warm water and isopropyl alcohol to clean the display screen. **Do not use** acetone, mineral spirits, turpentine type solvents, or ammonia based cleaning products. The use of strong solvents or detergents may damage the coating, the plastics, or the rubber keys on the gauges. If the gauge has a sun cover available, it is recommended that the cover be installed when the unit is not in use to prevent UV damage to the plastic bezels and rubber keys.

CLEANING REMOTE CONTROLS

IMPORTANT: Never use high-pressure water to clean remote controls.

MAINTENANCE

Routine cleaning of the remote control external surfaces is recommended to prevent a buildup of salt and other environmental debris. Use a cloth towel which has a sufficient amount of fresh water to dissolve and remove salt or mineral deposits.

When water marks cannot be removed with a damp cloth, mix a 50/50 solution of warm water and isopropyl alcohol to clean the remote control. **Do not use acetone, mineral spirits, turpentine type solvents, or ammonia based cleaning products.** The use of strong solvents or detergents may damage the coating, the plastics, or the rubber components on the remote control.

CLEANING COWLS

IMPORTANT: Do not wipe the plastic surface when it is dry. This action will result in minor surface scratches. Always wet the surface before cleaning. Do not use detergents containing hydrochloric acid. Follow the cleaning and waxing procedure.

Cleaning Procedure

1. Before washing, rinse the cowls with clean water to remove dirt and dust that may scratch the surface.
2. Wash the cowls with clean water and a mild nonabrasive soap. Use a soft clean cloth when washing.
3. Dry thoroughly with a soft clean cloth.

CLEANING UNDER COWL COMPONENTS (SALTWATER USE)

If the outboard is operated in saltwater, as part of annual maintenance, have an authorized dealer remove the cowling for inspection of salt buildup and cleaning of salt deposits on components. Wash off any salt buildup from the under cowl components with fresh water. After washing, allow the under cowl components to dry. Apply Quicksilver or Mercury Precision Lubricants Corrosion Guard spray on the external metal surfaces of the under cowl components.

IMPORTANT: Before applying Corrosion Guard under the cowl, ensure the battery connector is covered with the weather cap.

Description	Where Used	Part No.
Corrosion Guard	External metal surfaces of the under cowl components.	92-802878 55

Inspection and Maintenance Schedule

After each use of the outboard be sure to:

- Wash the power package exterior with fresh water. For precaution information, refer to **Outboard Cleaning**.

Daily Check
Check that activating the lanyard stop switch disables propeller rotation.

MAINTENANCE

Daily Check
Check the tightness of the transom clamp bolts and thumbscrews.
Check the steering system for binding.
Inspect the propeller for damage.
Inspect the battery for damage and proper installation.
Check the state of charge of the battery.

100 Hour Maintenance (100 Hours or Before Long-Term Storage)	Dealer Item
Charge the battery before long-term storage and charge every six months.	
Verify the condition and status of the battery charger.	
Inspect the corrosion control anode. Refer to Corrosion Control Anode .	
Tiller models only - Verify the quick-release feature is operational and the outboard is secured in place.	
Inspect the condition of the outboard lower unit housing paint. Use the appropriate paint to touch up nicks and scratches.	
Inspect the battery connections in the battery compartment and on the battery for damage, corrosion, or signs of excessive heat.	X
Inspect the outboard mounting hardware for damage and proper torque specifications.	X
Remote control models only - Ensure that the continuity wire between the transom bracket and outboard is intact and securely connected to the transom and outboard.	

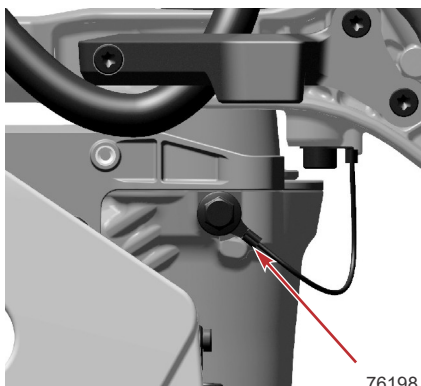

76198

MAINTENANCE

3 Year or 300 Hour Maintenance	Dealer Item
Remote control models only - Inspect the helm and outboard wire harness connectors. IMPORTANT: Do not use any type of contact cleaner on the helm or outboard wire harness. Contact cleaner is harmful to the seals of the connectors.	X
Inspect the trim feature for damage and ensure that it is working correctly.	X
Inspect the outboard lower unit isolation mounts for damage and proper torque specifications.	X
<ol style="list-style-type: none"> 1. Remove the propeller from the outboard. 2. Check the condition of the propeller shaft. 3. Inspect/replace the propeller shear pin. IMPORTANT: Do not apply grease to the threads of the shaft. <ol style="list-style-type: none"> 4. Apply Mercury 2-4-C Marine Grease to the propeller shaft where the propeller contacts the shaft. 	X

Corrosion Control Anode

The outboard has one corrosion control anode mounted on the underside of the anti-ventilation plate (AVP). The anode helps protect the outboard against galvanic corrosion by sacrificing its metal to be slowly corroded instead of the outboard metals.

MAINTENANCE

The anode requires periodic inspection, especially in saltwater, which will accelerate the erosion. To maintain corrosion protection, always replace the anode before it is completely eroded. Never paint or apply a protective coating on the anode, this will reduce the effectiveness of the anode.



Anode

Propeller Replacement

PROPELLER REMOVAL

▲ WARNING

Rotating propellers can cause serious injury or death. Never operate the boat out of the water with a propeller installed. Before installing or removing a propeller, place the outboard in neutral and activate the lanyard stop switch to prevent the outboard from starting.

1. Remove the battery from the outboard. Refer to **Battery Removal**.

IMPORTANT: The propeller blades are sharp.

2. Prevent the propeller blade from moving with an appropriate tool.
3. Remove the propeller nut from the propeller shaft.

NOTE: The propeller sheer pin may fall out of the propeller shaft while removing the propeller.

4. Remove the propeller from the propeller shaft.

MAINTENANCE

5. Remove and retain the propeller shear pin. Replace the pin if it is damaged.

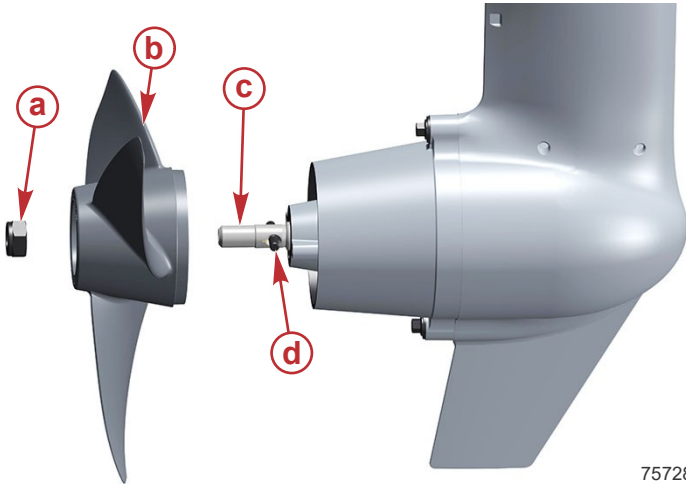

75728

- a - Propeller nut
- b - Propeller
- c - Shaft
- d - Propeller shear pin

PROPELLER INSTALLATION

⚠ WARNING

Rotating propellers can cause serious injury or death. Never operate the boat out of the water with a propeller installed. Before installing or removing a propeller, place the outboard in neutral and activate the lanyard stop switch to prevent the outboard from starting.

1. Remove the battery from the outboard. Refer to **Battery Removal**.
2. Remote control models-verify the remote control is in neutral.

IMPORTANT: To prevent the propeller hub from corroding and seizing to the propeller shaft (especially in saltwater), always apply a coat of the recommended lubricant to the non threaded areas of the propeller shaft at the recommended maintenance intervals.

Do not apply Extreme Grease or 2-4-C with PTFE to the threads of the propeller shaft.

MAINTENANCE

3. Apply Extreme Grease or 2-4-C with PTFE to the non threaded area of the propeller shaft.

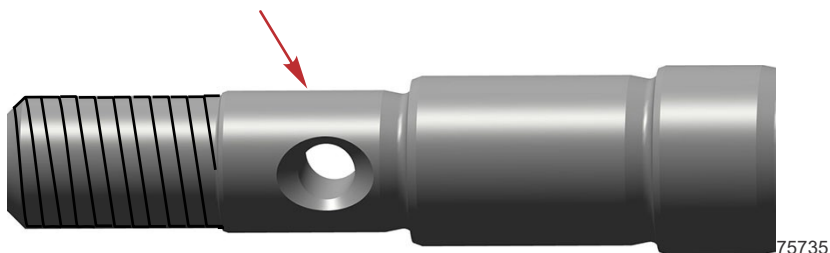

Description	Where Used	Part No.
Extreme Grease	Propeller shaft	8M0190472
2-4-C with PTFE	Propeller shaft	92-802859A 1

4. Install the propeller shear pin, propeller, and the propeller nut onto the shaft.

IMPORTANT: The propeller is sharp.

5. Prevent the propeller from moving with the appropriate tools.
6. Tighten the propeller nut to specified torque.

MAINTENANCE

Description	Nm	lb-in.	lb-ft
Propeller nut	8.5	75.2	–

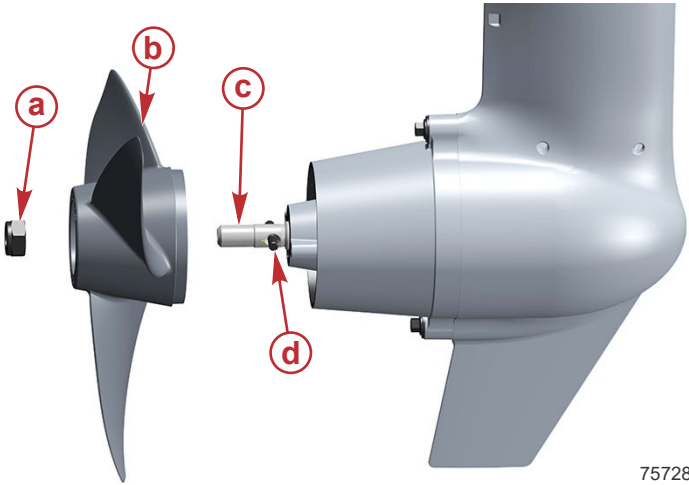

- a** - Propeller nut
- b** - Propeller
- c** - Shaft
- d** - Propeller shear pin

OUTBOARD STORAGE

Protecting External Outboard Components

- Lubricate all outboard components listed in **Inspection and Maintenance Schedule**.
- Touch-up any paint nicks. See the local dealer for touch-up paint.
- Spray Quicksilver or Mercury Precision Lubricants Corrosion Guard on external metal surfaces (except corrosion control anodes).

IMPORTANT: Do not apply corrosion guard to the exposed terminals of the battery connection.

Do not spray corrosion guard in the battery compartment unless the weather cap is applied to the battery connector.

Description	Where Used	Part No.
Corrosion Guard	External metal surfaces	92-802878 55

Outboard Storage

1. Remove the battery from the outboard. Refer to **Battery Removal**.
2. Remote control models only - follow the storage guidelines of the boat model.
3. Tiller models only - store the outboard in an appropriate position. Refer to **Handling the Outboard Separately From the Boat (Tiller Models Only)**

OUTBOARD STORAGE

Notes:

TROUBLESHOOTING

Fuse Replacement

LOCATION OF FUSES

The outboard 12-volt 5-amp fuse is located under the hood.



Fuse location

FUSE IDENTIFICATION AND REPLACEMENT

IMPORTANT: Always carry spare 5-amp 12-volt fuses.

Do not attempt to service the 48-volt circuit fuse. If suspected to be failed, the outboard needs to be serviced by an authorized technician.

The 48-volt circuit fuse is located behind the cowling.

IMPORTANT: Do not place a fuse of higher amperage rating in place of the 5-amp 12-volt fuse. Damage to the wiring or components of the outboard may result.

Remove the 5-amp 12-volt fuse and examine the silver colored band inside the fuse. If the band is broken, replace the fuse. Replace the fuse with a new fuse of the same rating.

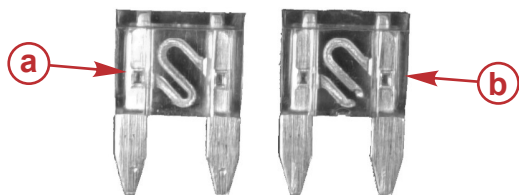

Identifying an open fuse

- a - Good fuse
- b - Open (blown) fuse

28619

TROUBLESHOOTING

Outboard Will Not Power Up

NOTE: If the outboard has discharged the battery to a very low state, the battery will need to be charged as soon as possible to prevent permanent battery damage and negative affects to the warranty of the battery.

If a fault is present upon powering on the outboard, do not use the outboard. The outboard needs to be serviced by an authorized technician.

Possible causes	Recommended maintenance
Incorrect outboard activation sequence.	Refer to Operation .
Battery connection is not secure.	Check the battery to make sure it is locked into position in the outboard.
Battery is discharged or faulted.	Press the button on the battery and to check the LED state. Refer to Battery State Of Charge (SOC) Status .
The fuse is open.	Refer to Maintenance .
Electrical or mechanical component failure.	The outboard needs to be serviced by an authorized technician.
Wiring or electrical connection faulty.	The outboard needs to be serviced by an authorized technician.

Outboard Losing Power Intermittently

Possible causes	Recommended maintenance
Lanyard stop switch is not completely in the operating position.	Ensure that the lanyard is installed correctly.
Battery is overheating.	Check the system for faults related to over-temperature and verify the audible alarm is functioning.
Low battery.	Check the SOC by pressing the button on the battery or referencing the display for SOC.
Battery connection is not secure.	Check the battery to make sure it is locked into position.
Poor wiring connections.	Check all exposed wiring connections.

Performance Loss

Possible causes	Recommended maintenance
Low battery.	Check the SOC of battery by pressing the button on the battery or referencing the display for SOC.

TROUBLESHOOTING

Possible causes	Recommended maintenance
Tiller control throttle or remote control throttle not working correctly.	Check operation for free travel and ensure that there are no faults.
Damaged or improper size propeller.	Refer to Specifications or Propeller Replacement .
Boat overloaded or load improperly distributed.	Distribute the weight evenly.
Excessive water in bilge.	Drain water from the bilge.
Boat bottom is dirty or damaged.	Clean the boat.

Battery Will Not Hold Charge

IMPORTANT: Imminent and permanent battery failure can be caused by each of the following abusive scenarios: Battery overheating, storing the battery for extended periods while depleted, punctures to the battery casing, damage from dropping, water submersion, or incorrectly connecting external wiring creating a short circuit. Never try to use a battery that has case damage, was submerged, short circuited, or has a fault indicating failure on the LED battery status lights. Refer to Battery State Of Charge (SOC) Status.

Possible Causes	Recommended Maintenance
Battery connections are loose or corroded.	The outboard needs to be serviced by an authorized technician.
The outboard is being used in environment at or below freezing temperatures 0 °C (32 °F).	
Worn out or inefficient battery.	
Unapproved electrical accessories drawing power from the Avator battery.	
Defective battery or electrical components.	

Battery Will Not Charge with Charger

Possible Causes	Recommended Maintenance
Charger not compatible with Avator outboard.	IMPORTANT: Do not use any charger except Mercury Avator specific chargers. Aftermarket chargers may damage the battery.
Poor connection between the charger and the battery.	Ensure full engagement of the connectors between the battery and charger.

TROUBLESHOOTING

Possible Causes	Recommended Maintenance
Battery temperature is elevated.	Disconnect the charger and allow the battery to cool before reconnecting.
Battery is faulted.	Use the LEDs on the charger and battery to determine faults, charge status, and charger function.

OPERATOR SERVICE ASSISTANCE

Service Assistance

LOCAL REPAIR SERVICE

If service is needed for the Mercury outboard powered boat, take it to an authorized dealer. Only authorized dealers specialize in Mercury products and have factory-trained technicians, special tools and equipment, and genuine Mercury Avator parts and accessories to properly service the outboard.

NOTE: *Mercury Avator parts and accessories are engineered and built by Mercury Marine specifically for the power package.*

SERVICE AWAY FROM HOME

If the operator is away from the local dealer and the need arises for service, contact the nearest authorized dealer. If, for any reason, service cannot be obtained, contact the nearest Regional Service Center. Outside the United States and Canada, contact the nearest Marine Power International Service Center.

STOLEN POWER PACKAGE

If the power package is stolen, immediately advise the local authorities and Mercury Marine of the model and serial numbers and to whom the recovery is to be reported. This information is maintained in a database at Mercury Marine to aid authorities and dealers in the recovery of stolen power packages.

ATTENTION REQUIRED AFTER SUBMERSION

Refer to **Handling Damaged or Submerged Products** before reading the following section.

A submerged outboard will require service within a few hours by an authorized dealer once the outboard is recovered from the water. This immediate attention by a servicing dealer is necessary once the outboard is exposed to the atmosphere to minimize electrical connector and outboard corrosion damage. Do not attempt to use an outboard or battery that has been submerged without seeking authorized service for the submerged components.

1. Before recovery, contact an authorized Mercury dealer.
2. After recovery, immediate service by an authorized Mercury dealer is required to reduce the possibility of serious outboard damage.

REPLACEMENT SERVICE PARTS

WARNING

Avoid fire or explosion hazard. Battery, motor, and electrical wiring components on Mercury Marine products comply with federal and international standards to minimize risk of fire or explosion. Do not use replacement battery, motor, or electrical wiring components that do not comply with these standards. When servicing the electrical system, properly install and tighten all components.

OPERATOR SERVICE ASSISTANCE

Mercury Avator batteries and outboards are designed and built using purposed parts for marine environments, both fresh and salt water. Using aftermarket parts or components may cause premature failure, damage, or expose the operator to safety risks. Use only Mercury Avator parts and components with the outboard.

PARTS AND ACCESSORIES INQUIRIES

Direct any inquiries concerning genuine Mercury Avator parts or accessories to a local authorized dealer. Dealers have the proper systems to order parts and accessories. Outboard and battery **serial numbers** are required to order correct parts.

RESOLVING A PROBLEM

Satisfaction with the Mercury product is important to the dealer and to Mercury Marine. If there is ever a problem, question, or concern about the power package, contact the dealer or any authorized Mercury dealership. If additional assistance is needed:

1. Talk with the dealership's sales manager or service manager.
2. If the question, concern, or problem cannot be resolved by the dealership, please contact the Mercury Marine Service Office for assistance. Mercury Marine will work with the operator and the dealership to resolve all problems.

The following information will be needed by Mercury Customer Service:

- Operator name and address
- Operator daytime telephone number
- The model and serial numbers of the outboard and batteries
- The name and address of the dealership
- The nature of the problem

CONTACT INFORMATION FOR MERCURY MARINE CUSTOMER SERVICE

For assistance, call, fax, or write to the geographic office in the area. Please include a daytime telephone number with mail and fax correspondence.

United States, Canada		
Telephone	English +1 920 929 5040 Français +1 905 636 4751	Mercury Marine W6250 Pioneer Road P.O. Box 1939 Fond du Lac, WI 54936-1939
Fax	English +1 920 929 5893 Français +1 905 636 1704	
Website	www.mercurymarine.com	

OPERATOR SERVICE ASSISTANCE

Australia, Pacific		
Telephone	+61 3 9791 5822	Brunswick Asia Pacific Group 41-71 Bessemer Drive Dandenong South, Victoria 3175 Australia
Fax	+61 3 9706 7228	

Europe, Middle East, Africa		
Telephone	+32 87 32 32 11	Brunswick Marine Europe Parc Industriel de Petit-Rechain B-4800 Verviers, Belgium
Fax	+32 87 31 19 65	

Mexico, Central America, South America, Caribbean		
Telephone	+1 954 744 3500	Mercury Marine 11650 Interchange Circle North Miramar, FL 33025 U.S.A.
Fax	+1 954 744 3535	

Asia, Singapore, Japan		
Telephone	+65 68058100	Mercury Marine Singapore Pte Ltd 11 Changi South Street 3, #01-02 Singapore, 486122
Fax	+65 68058138	

Handling Damaged, Defective, or Submerged Products

IMPORTANT: Damaged, defective, or submerged batteries are at an increased risk of combustion. Do not use Avator batteries that appear damaged, feel hot to the touch, or appear swollen or bulging. Treat defective, faulty, or recalled batteries with these same precautions.

▲ CAUTION

Avoid hazards from possible battery fire. Batteries that have been compromised by water intrusion or other means are potentially susceptible to combustion. If a battery is suspected of having been compromised, contact a Mercury Marine Authorized Dealer as soon as possible. Do not store the affected battery indoors, in a vehicle, or near any flammable materials.

OPERATOR SERVICE ASSISTANCE

IMPORTANT: A battery is assumed to be compromised if any of the following apply:

- Battery has been submerged.
- Internal battery components have been exposed to water.
- Battery has been dropped from a height greater than 1 m (3.28 ft).
- Battery has external damage to the case, or is pierced.
- Battery has been recalled for a risk of combustion.
- Battery is not functional (excluding batteries that are at end-of-life or have discharged completely).
- Battery external surfaces are hotter than 60 °C (140 °F).
- Battery appears swollen or will not fit inside of the outboard cavity.
- Battery is venting foul smelling gas, vapors, or smoke.

A submerged outboard and battery will require immediate attention once retrieved from the water. The battery may have water intrusion that can result in an internal failure that may result in a fire. This may occur up to several days after submersion. Use extreme caution if transporting a battery that has been submerged. Do not store a battery that has been submerged indoors, in a vehicle, or near any other combustible materials. Contact a Mercury Marine Authorized Dealer for further instructions before transporting the battery. If the entire outboard is submerged, it will require service to make sure all the components are cleaned and properly dried to prevent corrosion and future electrical issues. Contact a Mercury Marine Authorized Dealer for service.

Ordering Literature

Before ordering literature, have the following information about the power package available:

Model		Outboard Serial Number	
KiloWattHour rating or HP output			

UNITED STATES AND CANADA

For additional literature for the Mercury Marine power package, contact the nearest Mercury Marine dealer or contact:

Mercury Marine		
Telephone	Fax	Mail
(920) 929-5110	(920) 929-4894	Mercury Marine Attn: Publications Department P.O. Box 1939 Fond du Lac, WI 54936-1939

OPERATOR SERVICE ASSISTANCE

OUTSIDE THE UNITED STATES AND CANADA

Contact the nearest Mercury Marine authorized service center to order additional literature that is available for the particular power package.

Submit the following order form with payment to:	Mercury Marine Attn: Publications Department W6250 Pioneer Road P.O. Box 1939 Fond du Lac, WI 54936-1939
--	--

Ship To: (Copy this form and print or type—This is the shipping label)

Name	
Address	
City, State, Province	
ZIP or postal code	
Country	

Quantity	Item	Stock Number	Price	Total
			.	.
			.	.
			.	.
			.	.
			.	.
Total Due			.	.

OPERATOR SERVICE ASSISTANCE

Notes:

MAINTENANCE LOG

Notes:

PREDELIVERY INSPECTION (PDI)

Predelivery Inspection (PDI)

OUTBOARD INFORMATION

Outboard Information	
Outboard kilowatt rating/Mercury Avator power rating	
Outboard serial number	
Battery serial number(s)	
Propeller size	
Boat brand	
Boat model	
Boat length	

TECHNICIAN INFORMATION

I certify that the following checks and inspections have been completed.

Inspector/Mechanic Completing Inspection	
First	
Last	
Technician ID	
Date	
Account number	

OUTBOARD

- All service bulletin updates completed?
- Secure transom bracket bolts and thumbscrews - Transom mount bolts tightened to the service manual specification (if used).
- Are all outboard power connections tight and sealed (covered) to prevent corrosion or accidental short circuits?
- Is this a tiller model or remote (helm) controlled outboard?
- What propeller type and pitch are installed?
- Tighten the propeller nut to the specified torque. Refer to **Propeller Installation**.

SOFTWARE AND DISPLAY

Verified that the display is functional and has current software?

Record software versions	
Display software version	

PREDELIVERY INSPECTION (PDI)

Battery software version	
SmartCraft CONNECT (if installed) software version	

- Can tiller throttle directional operation be changed from display?
- Battery state of charge (SOC) levels report correctly and accurately on display?
- Verified all audible and displayed warning systems operation?

OUTBOARD STEERING

- Tiller models: Does tiller throttle function?
- Tiller models: Is tiller lanyard included and does tiller lanyard function?
- Tiller models: Does tiller tension adjust function correctly?

BATTERY

Battery	
Battery kWh rating	
Battery charge level in display	

- The battery charge indicator is working.

BATTERY CHARGER

- Is the battery charger packaged and included with the boat?
- Is the battery charger functional?

HELM RIGGING (IF EQUIPPED)

- Does the boat have an accessible 10-pin diagnostic port?
- Does the rigging in the helm appear organized?
- Proper component installation orientation?
- Proper wiring retention and strain relief?
- Proper wiring service/drip loop to prevent water intrusion?
- Harnessing routed free of obstructions and provide chafe protection?
- Do all unused SmartCraft and NMEA 2000 terminals have weather caps installed?
- Were any corrections made to the helm rigging?

What were the corrections?	
----------------------------	--

PREDELIVERY INSPECTION (PDI)

BATTERIES

How many batteries are being sold with this outboard?	
Provide kWh of each battery	

- Are switch box connections tight?
- Has correct cable stacking been followed with protective covering installed?

GENERAL HARNESS ROUTING

- Proper switch box orientation and mounted in a suitable location?
- Proper data harness and power supply wiring retention and strain relief?
- Proper wiring service/drip loop to prevent water intrusion?
- If equipped are remote control and electric helm connected and proper strain relief observed?
- Does the boat have an electrical bonding circuit?
- Harnessing routed free of obstructions and provide chafe protection?

ON-THE-WATER TEST

- Is the relief plug installed(if equipped)?
- Verify the lanyard stop switch operates.
- Displays are fully functional and operational?
- F/N/R gear operation verified?
- Acceleration from idle RPM is normal?

Top speed - trimmed if power trim (if equipped).	
Top speed - tucked - if power trim (if equipped).Provide kWh of each battery	

- Power trim operates fully throughout range (if equipped)?
- Maneuver the boat to port and starboard ensuring proper friction of tiller.
- Does the boat maneuver port to starboard in a predictable and controllable manner?

What was the battery charge level at before test?	
---	--

PREDELIVERY INSPECTION (PDI)

AFTER ON-THE-WATER TEST

What was battery charge level after test?	
Were any electrical issues observed?	
Were any signs of heat to wiring or fuse holders observed?	

Check battery levels post water test.

Submit full report with PDI. Completion date.	
--	--

Clear all Freeze Frames and save a full report. Completed?

Submit a full report with faults and history cleared to Mercury Technical Service and list email address.

CUSTOMER DELIVERY

Daily inspections/maintenance/documentation?

Explained and demonstrated procedure to check battery levels.

Explained and demonstrated changing throttle friction.

Explained and reviewed long-term storage and charging.

For portable units, explained how to remove and carry outboard and batteries.

Reviewed operation, maintenance, and installation manual with customer?

Provided and reviewed outboard warning systems to customer?

Provided and reviewed battery charging recommendations including storage temperature requirements?

Explain the Mercury Avator App (if equipped)?

Tiller models only, demonstrated and explained how to reverse the tiller handle rotation left to right?

HELM

Explain and review display features:

Range, distance to empty.	
Range, time to empty.	
Battery percentage remaining.	

PREDELIVERY INSPECTION (PDI)

Boat speed and source (GPS in display).	
---	--

- Electric steering operational and handling characteristics acceptable?
- Explain and review the remote control features and operation (if equipped)?

BOAT

- Reviewed all boat electrical systems (lights, breakers, pumps) with consumer?
- Has the customer approved the external appearance and condition of product?

SAFETY

- Operation of all safety equipment- Explain and demonstrate?
- Operation of E-stop lanyard- Explain and demonstrate?
- Reviewed boat capacity plate with customer?
- Reviewed proper seating?
- Reviewed importance of personal floatation devices and throwable PFD's?

TECHNICIAN CERTIFICATION

- I certify that the above information has been provided and explained to the customer.

Salesperson	
First	
Last	
Date	
Customer	
Signature	
Date	