

PURE SINE WAVE INVERTER

GP-ISW-200/400

User Manual



© 2018 Go Power!®

Worldwide Technical Support and Product Information gpelectric.com

Go Power! Headquarters
201-710 Redbrick St, Victoria, BC Canada V8T 5J3
Tel: 1.866.247.6527



82654_MAN_ISW200-400_RevA



Congratulations on purchasing your Go Power! GP-ISW Inverter. The unit is a highly reliable DC-AC inverter system, designed with advanced power electronic and microprocessor technology offering the following features;

- Pure Sine wave output (THD <5%).
- Intelligent power management software.
- Load and temperature controlled cooling fan.
- GP-SWR-A/GP-ISW-R management and control.
- Dry contact terminals.
- Advance protection features;
 - Input over/under voltage protection.
 - Internal over temperature protection.
 - Input reverse polarity protection (fuse).
 - Output overload protection.
 - Output short-circuit protection.



Product Packaging

Please safely store the packaging the GP-ISW was delivered in or please recycle the packaging components as outlined below;

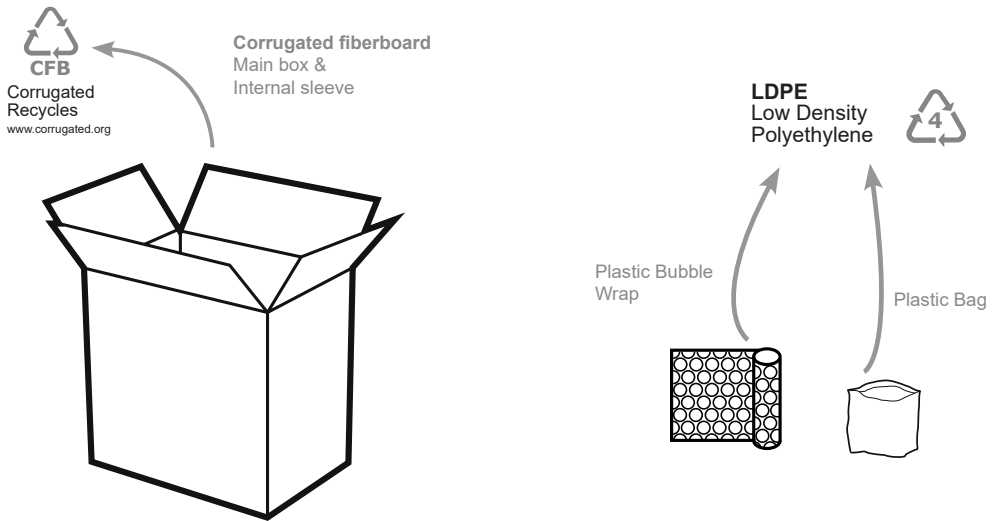

Local recycling centres can be found here;
www.earth911.com/recycling-center-search-guides



1. CONTENTS

2.	GENERAL INFORMATION	4
2.1	CAUTIONS / WARNINGS	4
2.2	DISCLAIMERS	10
2.3	GP-ISW KIT PARTS	11
2.3.1	PARTS CHECKLIST	11
2.4	UNIT DIMENSIONS	12
2.5	VOLTAGE AND TEMPERATURE PERFORMANCE	13
3.	INSTALLATION	15
3.1	TYPICAL SYSTEM OVERVIEW	15
3.2	MOUNTING REQUIREMENTS	16
3.3	DC WIRING	18
3.3.1	DC WIRING SIZING	19
3.3.2	DC OVERCURRENT PROTECTION	20
3.3.3	PREPARING THE DC CABLES	20
3.3.4	DC CABLE CONNECTIONS	20
3.3.5	WIRING THE INVERTER TO THE BATTERIES	21
3.3.6	DC GROUNDING	22
3.4	AC WIRING	22
3.4.1	AC OUTPUT INTERFACE	23
3.4.2	GP-ISW 200/400AC OUTPUT INTERFACE	23
4.	OPERATION	25
4.1	FINAL INSPECTION	26
4.2	TESTING THE INSTALLATION	26
4.3	CONNECTING THE AC LOADS	26
4.4	LED INDICATORS	26
4.4.1	INPUT VOLTAGE LEVEL	26
4.4.2	INVERTER STATUS TO DISPLAY FAULT CONDITION	27
4.5	FUNCTION SWITCH	28
4.5.1	OUTPUT VOLTAGE SELECTION (S1&S2)	28
4.5.2	OUTPUT FREQUENCY SELECTION (S3)	28
4.6	POWER SAVING SELECTION (S4)	28
4.8	SHUTDOWN CONDITIONS	29
5.	WARRANTY RETURN PROCEDURE	30
6.	PRODUCT END OF LIFE & RECYCLING	31



2. GENERAL INFORMATION

2.1 CAUTIONS / WARNINGS

This document contains important safety instructions for the products produced by Go Power. Read all instructions and cautionary markings on the product and on any accessories or additional equipment included in the installation. Failure to follow these instructions could result in severe shock or possible electrocution. Use extreme caution at all times to prevent accidents.

All electrical work must be performed in accordance with local and national electrical codes. These instructions are for use by qualified personnel who meet all local and governmental code requirements for licensing and training for the installation of electrical power systems with AC and DC voltage up to 600 volts.

Installation, maintenance, and connection of inverters must be performed by qualified personnel, in compliance with local electrical standards, wiring rules, and the requirements of local power authorities and/or companies.

Safety regulations relevant to the location shall be followed during installation, operation and maintenance. Improper operation may have a risk of electric shock or damage to equipment and property.



WARNING!
Hazard to Human Life

This type of notation indicates that the hazard could be harmful to human life.



WARNING!
Shock Hazard

Danger of shock or electrocution.



WARNING!
Burn / Fire Hazard

Danger of hot surface and/or fire.



CAUTION!
Hazard to Equipment

This type of notation indicates that the hazard may cause damage to the equipment.



IMPORTANT

This type of notation indicates that the information provided is important to the installation, operation and/or maintenance of the equipment. Failure to follow the recommendations in such a notation could result in annulment of the equipment warranty.

General Safety

WARNING!
Limitations on Use

This equipment is NOT intended for use with life support equipment or other medical equipment or devices.

CAUTION!
Equipment Damage

This product is designed for indoor/compartment installation. It must not be exposed to any liquids, moisture of any type.

Only use components or accessories recommended or sold by Go Power! or its authorized agents.

IMPORTANT

Do not attempt to install this equipment if it appears to be damaged in any way. See the Warranty section for instructions on returning the equipment.

Personal Safety



WARNING!
Personal Injury

Use safe lifting techniques when lifting this equipment as recommended by the Occupational Safety and Health Association (OSHA) or other local codes.

Use standard safety equipment when working on this equipment, such as safety glasses, ear protection, steel-toed safety boots, safety hard hats, etc.

Use standard safety practices when working with electrical equipment. (Remove all jewelry, use insulated tools, wear cotton clothing, etc.)

Never work alone when installing or servicing this equipment. Have someone nearby that can assist if necessary.

Ensure that children, pets, and other animals are kept away from the inverter, solar arrays, battery bank, and utility grid components.

If the equipment is used in a manner not specified by the manufacturer, the protection provided by the equipment may be impaired.

Equipment Safety



WARNING!
Lethal Voltage

Review the system configuration to identify all possible sources of energy. Ensure ALL sources of power are disconnected before performing any installation or maintenance on this equipment. Confirm that the terminals are de-energized using a validated voltmeter (rated for a minimum 1000 VAC and 1000 VDC) to verify the de-energized condition.

Do not perform any servicing other than that specified in the installation instructions unless qualified to do so, or have been instructed to do so by Go Power! Technical Support personnel.

To avoid electric shock, disconnect the DC input and AC input of the inverter at least 5 minutes before performing any installation or maintenance.

Do not tighten the AC and DC terminals or pull on the AC and DC wiring when the inverter is running.



WARNING!
Fire Hazard

Do not keep combustible or flammable materials in the same room with the equipment. Some products contain relays with moving parts and are not ignition-protected.

Ensure AC, DC, and ground cable sizes conform to local codes. See product manuals for minimum size requirements.

Ensure all conductors are in good condition.

Do not operate the unit with damaged or substandard cabling.



CAUTION!
Equipment Damage

When connecting cables from the inverter to the battery terminals, ensure the proper polarity is observed. Connecting the cables incorrectly can damage or destroy the equipment and void the product warranty.

Thoroughly inspect the equipment prior to energizing. Verify that no tools or equipment have been inadvertently left behind.

Keep all vents clear of obstructions that can prevent proper air flow around, or through, the unit.

CAUTION!
Equipment Damage

Static electricity may damage electronic components. Take appropriate steps to prevent such damage to the inverter; otherwise the warranty may be annulled.

Battery Safety



Ensure the cables (conductors) are properly sized.

Ensure clearance requirements are strictly enforced around the batteries.



Ensure the area around the batteries is well ventilated and clean of debris.

Never smoke, or allow a spark or flame near the batteries.

WARNING!

Explosion, Electrocution,
or Fire Hazard

Always use insulated tools. Avoid dropping tools onto batteries or other electrical parts.

Never charge a frozen battery.

Never use old or untested batteries. Check each battery's label for age, type, and date code to ensure all batteries are identical.

If a battery must be removed, always remove the grounded terminal from the battery first. Make sure all devices are de-energized or disconnected to avoid causing a spark.

Use the battery types recommended by Go Power. Follow the battery manufacturer's recommendations for installation and maintenance.

Insulate batteries as appropriate against freezing temperatures. A discharged battery will freeze more easily than a charged one.



IMPORTANT

If a remote or automatic generator control system is used, disable the starting circuit and/or disconnect the generator from its starting battery while performing maintenance to prevent accidental starting.

Wear complete eye and clothing protection when working with batteries. Avoid touching bare skin or eyes while working near batteries.

Keep plenty of fresh water and soap nearby in case battery acid contacts skin, clothing, or eyes.

If battery acid contacts skin or clothing, wash immediately with soap and water. If acid enters the eye, immediately flood it with running cold water for at least 20 minutes and get medical attention as soon as possible.



CAUTION!

Equipment Damage

When connecting cables from the inverter to the battery terminals, ensure the proper polarity is observed. Connecting the cables incorrectly can damage or destroy the equipment and void the product warranty.

Thoroughly inspect the equipment prior to energizing. Verify that no tools or equipment have been inadvertently left behind.

Ensure clearance requirements are strictly enforced.

Keep all vents clear of obstructions that can prevent proper air flow around, or through, the unit.

CAUTION!

Equipment Damage

Static electricity may damage electronic components. Take appropriate steps to prevent such damage to the inverter; otherwise the warranty may be annulled.



2.2 DISCLAIMERS

IMPORTANT: Please follow installation and wiring instructions exactly as outlined to ensure safety. We recommend installation by an RV/marine technician or professional electrician to ensure adherence to relevant electrical codes. We have made every reasonable effort to ensure the accuracy of the instructions in this manual, but Go Power does not guarantee that the information is error free, nor do we make any other representation, warranty or guarantee that the information is accurate, correct, reliable or current. The specifications in this manual are for reference purposes only and are subject to change without notice. For additional information please see www.gpelectric.com.

DISCLAIMER: Go Power disclaims liability for any direct, indirect or incidental damages caused by, or in case of, installation not performed following the instructions and cautions in this manual. Go Power will refuse requests for exchanges or returns, resulting from the purchase and installation of items which do not comply with local codes. To avoid such concerns Go Power recommends installation by a professional electrician or RV technician. Examples that are shown within this manual are for illustrative purposes only.

2.3 GP-ISW KIT PARTS

Please unpack and make sure all parts shown in the list below are included in the kit. If any parts are missing please contact Go Power customer service team at customersupport@gpelectric.com or 1.866.247.6527.

2.3.1 PARTS CHECKLIST

ITEM #	DESCRIPTION	
01	GP-ISW Unit	1
02	Ring Terminal	2

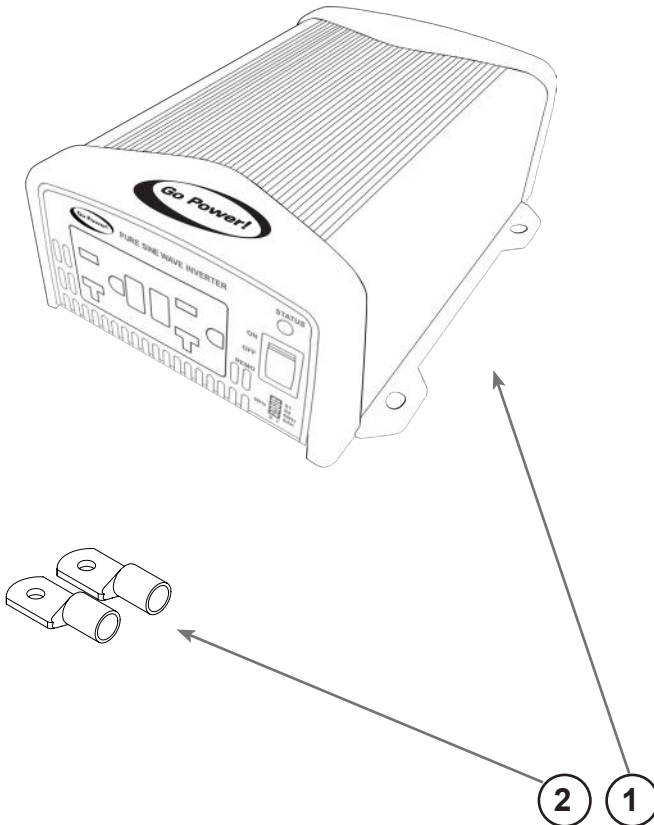

2.4 UNIT DIMENSIONS

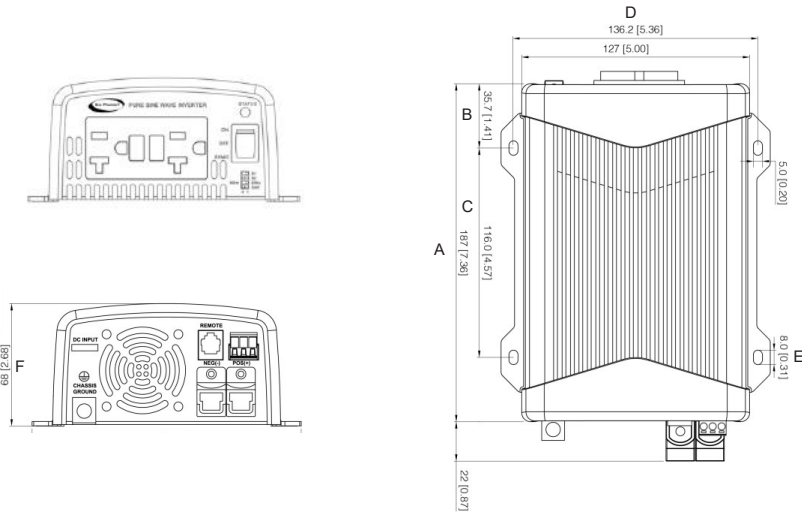

Model	A (mm)	B (mm)	C (mm)	D (mm)	E (mm)	F (mm)
GP-ISW200	144	32.5	116	132	8.0	62
GP-ISW400	187	35.7	116	136	8.0	68
GP-ISW700	330	80	132	200	7.0	83
GP-ISW1000	372	69	196	200	7.0	83
GP-ISW1500	421	92	196	248	7.0	83
GP-ISW2000	443	103	196	248	7.0	83
GP-ISW3000	442	103	196	255	7.0	158
GP-ISW4000	462	113	196	255	7.0	158

2.5 VOLTAGE AND TEMPERATURE PERFORMANCE

GP-ISW-200 Specification

Electrical	Specification	Model No.	
	Item	GP-ISW-200-12	GP-ISW-200-24
Input	Voltage	12VDC	24VDC
	Voltage Range	10.0~16.0VDC	20.0~32.0VDC
	No Load Current	< 0.5A	< 0.4A
	Power Saving Mode	< 0.12A	< 0.06A
	Efficiency (Typ.)	89%	91%
	On Mode @ Save Mode	< 0.12A	< 0.06A
	On Mode @ No Load Mode	< 0.5A	< 0.4A
Output	Continuous Output Power	200 W	
	Over Rated Power (3 Min.)	230 W	
	Surge Power (3 Sec.)	250 W	
	Frequency	50 / 60 Hz ± 0.5% (Dip Switch Selectable)	
	Output Voltage	100 / 110 / 115 / 120 VAC ± 5% (Dip Switch Selectable)	
	Short-Circuit Protection	2 seconds and restart 3 times shutdown	
	Output Waveform	Pure Sine Wave (THD < 3%@ Normal Load)	
Protection	Input Over-Voltage Protection	16.0VDC ± 3%	32.0VDC ± 3%
	Input Under-Voltage Protection	10.0VDC ± 3%	20.0VDC ± 3%
	BAT. Low Shutdown	10.0VDC ± 3%	20.0VDC ± 3%
	BAT. Low Alarm	10.5VDC ± 3%	21.0VDC ± 3%
	BAT. Low Restart	12.5VDC ± 3%	25.0VDC ± 3%
	BAT. High Alarm	15.5VDC ± 3%	31.0VDC ± 3%
	BAT. High Shutdown	16.0VDC ± 3%	32.0VDC ± 3%
	BAT. High Restart	14.5VDC ± 3%	29.0VDC ± 3%
Environment	Working Temp.	-20°C ~ 60°C	
	Storage Temp.	-30°C ~ 70°C	
	Working Humidity	10~95% RH, non condensing	
Safety & EMC	Safety Standards	----	
	EMC standards	Certified FCC class B	
	E-mark	----	
Others	Dimension(WxHxD)	150 mm X 68mm X187 mm	
	Weight	1.6kg	
	Remote Control	GP-SWR-A or GP-ISW-R	
	Cooling	Temperature & Load Controlled cooling Fan	

Table 1. GP-ISW-200 Specification



Note :

This test condition is normal DC input and temperature 25°C

GP-ISW-400 Specification

Electrical	Specification	Model No.	
	Item	GP-ISW-400-12	GP-ISW-400-24
Input	Voltage	12VDC	24VDC
	Voltage Range	10.5~16.0VDC	2 1.0~32.0VDC
	No Load Current	< 1A @12VDC	< 0.5A @24VDC
	Power Saving Mode	< 0.2A @12VDC	< 0.1A @24VDC
	Efficiency (Typ.)	10%	89%
	On Mode @ Save Mode	< 1A @12VDC	< 0.5A @24VDC
	On Mode @ No Load Mode	< 0.2A @12VDC	< 0.1A @24VDC
Output	Continuous Output Power	400 W (± 3%)	
	Over Rated Power (1 Min.)	> 400 W~460 W (100%~115%)	
	Peak Power (3 Sec.)	800 W	
	Frequency	50 / 60 Hz ± 0.5% (Dip Switch Selectable)	
	Output Voltage	100 / 110 / 115 / 120 VAC ± 5% (Dip Switch Selectable)	
	Short-Circuit Protection	1 second shutdown	
	Output Waveform	Pure Sine Wave (THD < 5%@ Normal Load)	
Protection	Input Over-Voltage Protection	16.0VDC ± 0.3VDC	32.0 ± 0.5VDC
	Input Under-Voltage Protection	10.5VDC ± 0.3VDC	21.0VDC ± 0.5VDC
	BAT. Low Shutdown	10.5VDC ± 0.3VDC	21.0VDC ± 0.5VDC
	BAT. Low Alarm	10.5VDC ± 0.3VDC	21.0VDC ± 0.5VDC
	BAT. Low Restart	14.5VDC ± 0.3V	28.0VDC ± 0.5VDC
	BAT. High Shutdown	16.0 ± 0.3V	32.0VDC ± 0.3VDC
	BAT. High Restart	12.5VDC ± 0.3V	25.0VDC ± 0.3V
Environment	Working Temp.	-20°C ~ 40°C	
	Storage Temp.	-30°C ~ 70°C	
	Working Humidity	10~95% RH, non-condensing	
Safety & EMC	Safety Standards	Certified UL 458 (UL only for GFCI receptacles)	
	EMC standards	Certified FCC class B	
	E-mark	----	
Others	Dimension(WxHxD)	150 mm X 68mm X187 mm	
	Weight	1.3kg	
	Remote Control	GP-SWR-A or GP-ISW-B	
	Cooling	Temperature & Load Controlled cooling Fan	

Table 2. GP-ISW-400 for output 100/110/115/120 VAC Specification



Note :

- ① Normal load Condition : $V_{in} = 12.5V/25V/50V$, $V_o = 100/110/115/120$ VAC 80% load (PF=1.0)
- ② Voltage performance : Please refer to Figure 2
- ③ Temperature performance : Please refer to Figure 3

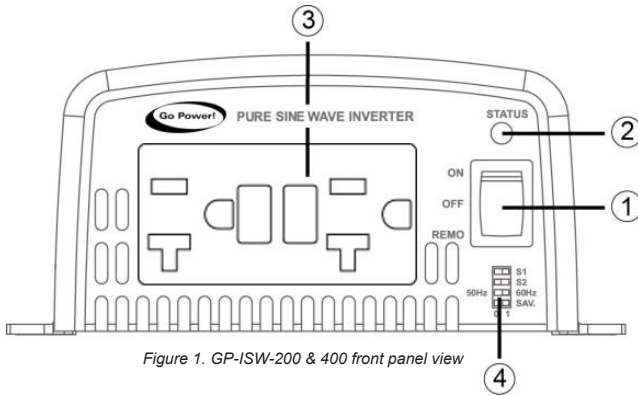

Figure 1. GP-ISW-200 & 400 front panel view

1	ON / OFF / Remote Main Switch
2	LED Indicator
3	AC Output
4	Function Switch

ON / OFF / Remote Main Switch ❶

The 3-stage switch ❶ is for turning on, turning off and remote mode.

LED Indicator ❷

Inverter status to display fault condition

3. INSTALLATION

3.1 TYPICAL SYSTEM OVERVIEW

The following diagrams show how the GP-ISW-Inverter and GP-ISW-R are typically installed in a mobile RV application. The diagrams show where the remote and Inverter are installed and how the mobile power system can be integrated with a Go Power! RV Solar Kit (sold separately by Go Power!, please contact an authorized dealer directly).

3.2 MOUNTING REQUIREMENTS

1. TEMPERATURE

Make sure the GP-ISW is installed in a location where the normal air temperature is between -20°C and 40°C. The cooler the better within this range.

2. MOISTURE

Do not allow water or other fluids to come into contact with the GP-ISW. Do not expose to rain, snow or water.

3. VENTILATION

For optimum Inverter performance the GP-ISW must be installed so the front and rear air vents are not blocked or obstructed in any way. Do not install the GP-ISW in an area with limited air flow. Allow as much space around the Inverter as possible, leaving at least 4 inches of airspace clearance around all ventilation areas.



CAUTION! Equipment Damage. Do not mount the GP-ISW in a zero clearance compartment. Do not cover the ventilation openings. Overheating and mechanical failure may occur.

4. FIRE

Install the GP-ISW away from the battery bank, away from any flammable or combustible material (paper, flammable liquids, gasoline, cloths) that may be ignited by heat, sparks or flames. Never place the Inverter directly above the battery bank - gases from the batteries will corrode and damage the Inverter, never allow battery acid to drip onto the unit.

5. ACCESSIBILITY / ORIENTATION

Do not block access to the GP-ISW remote control access port, status LEDs and the On/Off switch. Allow enough room to access the AC and DC wiring terminals and connections as they will need to be checked and tightened periodically. The GP-ISW must be installed in one of the approved mounting orientations detailed on page 20. **DO NOT MOUNT VERTICALLY.**

6. CLEAN

The GP-ISW should be installed in a location which is clean and limits the introduction of dust, fumes, insects or rodents which could enter and block the Inverter ventilation openings.

7. PROXIMITY TO BATTERY BANK

The GP-ISW should be located as close to the batteries as possible but not within the same compartment. The length and size of the DC Cables will affect performance. Long DC wires tend to lose efficiency and reduce the overall performance of the Inverter/Charger. Use the DC cables recommended on page 23.

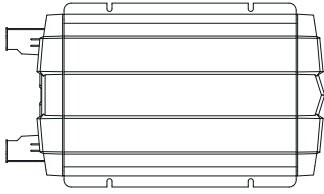

HORIZONTAL WALL MOUNT, BASE DOWN

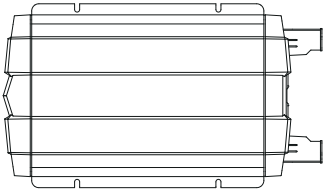

HORIZONTAL WALL MOUNT, BASE DOWN



HORIZONTAL MOUNT, BASE DOWN



HORIZONTAL MOUNT, BASE UP

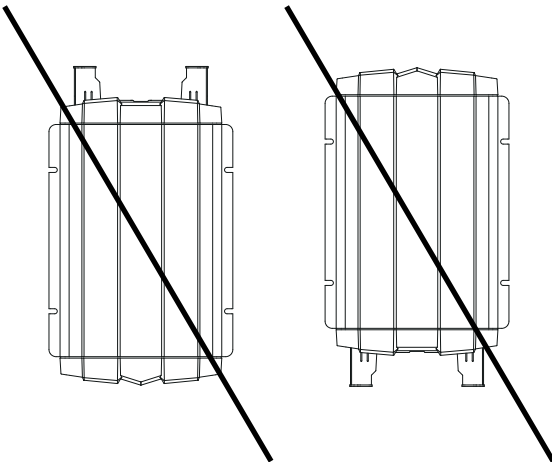

VERTICAL MOUNT, DO NOT MOUNT THE GP-ISW IN THIS CONFIGURATION

*GP-ISW model may not be exactly as shown

3.3 DC WIRING

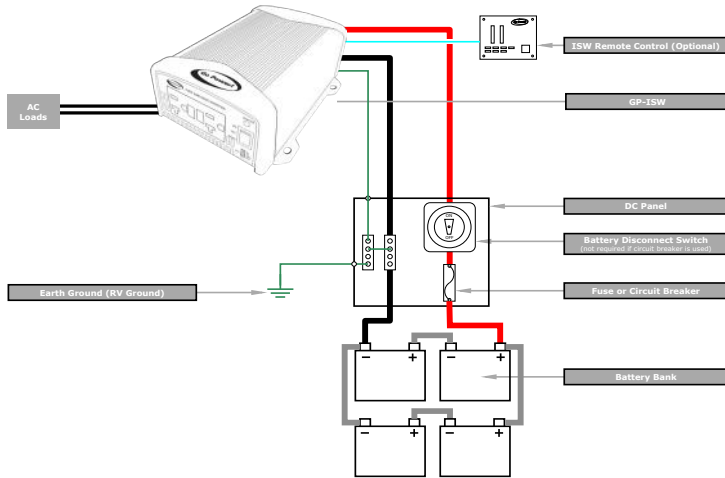

The following points must be observed for the DC Wiring.

- The DC positive and negative cables connected to the GP-ISW from the battery bank should be linked together with zip ties or electrical tape every 6". This helps to reduce radio frequency interference and reduces the effects of inductance both of which improve the Inverter waveform and reduces the wear of the Inverters filter capacitors.
- To ensure optimum Inverter performance the number of connections between the battery bank and the GP-ISW unit should be minimized except from the over-current and battery disconnect devices. All additional connection points will cause extra voltage drops.
- The Battery bank voltage must match the DC voltage required by the GP-ISW, which is 12V or 24V (note that the Inverter is either 12V or 24V, and is not switchable).
- All DC cable wire terminations should use a crimped and sealed copper ring terminal lugs.
- Make sure all cables have a smooth bend radius and no kinks are present.
- Color code all DC Cables coming to / from the battery bank. Use colored electrical tape or heat shrink tubing. Red for positive (+), Black for negative (-) and Green for DC ground.



3.3.1 DC WIRING SIZING

The distance between the battery bank and the GP-ISW should be as short as possible to achieve maximum efficiency and to reduce fire hazards. The size of the cable should be thick enough to limit the voltage drop to less than 2% when carrying the maximum input current to prevent frequent low-input voltage warnings and shutdown. Only use high quality copper wire.

For greater efficiency, the cables should be as short as possible. The combined cable length should be no more than 10ft (3m). Keeping your wire runs as short as possible helps to prevent: low voltage shutdowns and nuisance tripping of the DC breaker because of increased current draw. The table below shows the recommended DC cable size, fuses/circuit breakers and DC grounding cable sizes for the GP-ISW (**Note:** these values are correct for cables in free air, not conduit)

Model	Wire AWG	Inline Fuse / Circuit Breaker
GP-ISW200-12	#6	F-110A
GP-ISW200-24	#6	F-110A
GP-ISW400-12	#6	F-110A
GP-ISW400-24	#6	F-110A
GP-ISW700-12	#6	F-110A
GP-ISW700-24	#10	F-110A
GP-ISW1000-12	#4	F-110A
GP-ISW1000-24	#8	F-110A
GP-ISW1500-12	#2	F-200A
GP-ISW1500-24	#6	F-200A
GP-ISW2000-12	#2/0	F-300A
GP-ISW2000-24	#4	F-200A
GP-ISW3000-12	#4/0	F-400A
GP-ISW3000-24	#2	F-300A
GP-ISW4000-24	#2/0	F-400A



3.3.2 DC OVERCURRENT PROTECTION AND DC DISCONNECT

Batteries are capable of providing very large currents in case of a short circuit, if this occurs with no DC overcurrent protection, it will result in overheating and melting of the cables and possibly serious injury and/or fire.

DC overcurrent protection is not included with the GP-ISW Inverters. It must be installed between the Inverter and battery bank for safety reasons and to comply with code regulations.

The fuse should be as close to the positive battery terminal as possible. Use Bussmann ANN Class T series fuses (will also require Fuse Block 4164) or equivalent. Ideally, the fuse/circuit breaker should be installed within 18" (45cm) of the battery. The fuse required for DC Cable lengths up to 10ft is detailed in the above table.

In all installations a battery disconnect switch is required, if you install a circuit breaker for overcurrent protection this will suffice as a disconnect switch. If you install a fuse for overcurrent protection then a separate disconnect switch will need to be installed.

3.3.3 PREPARING THE DC CABLES

Go Power! supplies 2 ring lugs with the GP-ISW which can be used for the Inverter end of the DC Cables. Source the correct ring terminals for the batteries you are using.

- Cut the negative and positive cables to the required length.
- Strip off enough insulation so you can install the ring lugs provided.
- Use the correct crimp connector to install the ring lugs.
- Attach the connectors to both ends of both cables. Make sure no stray wire strands protrude from the connectors.

3.3.4 DC CABLE CONNECTIONS

When installing the battery cable ring lug onto the GP-ISW DC terminal and the battery post - do not put anything between the ring lug and the metal surface. Incorrectly installed hardware causes a high resistance connection which could lead to poor Inverter/Charger performance and may melt the cable and terminal connections. Tighten the terminal connections securely (torque to 9 – 10 ft-lbs, 11.7 – 13 Nm) and periodically check the connections to make sure they remain tight and secure.



To help prevent seizing and corrosion around the terminals the use of an anti-seize lubricant is highly recommended. Apply the antioxidant grease or spray after all the connections are made and tightened.

3.3.5 WIRING THE INVERTER TO THE BATTERIES

WARNING: Lethal currents will be present if the positive and negative cables attached to the battery bank touch each other. During the installation and wiring process, ensure the cable ends are insulated or covered to prevent shorting the cables.

WARNING: DO NOT connect the DC Wires from the battery bank to the GP-ISW until all the DC and AC wiring is complete and the AC overcurrent protection has been installed.

The GP-ISW comes in 12V or 24V versions. Make sure the battery bank is wired in series, parallel, or series-parallel to match the voltage of your inverter. The interconnecting wires between the individual batteries must be sized and rated exactly the same as those used between the battery bank and Inverter.

To ensure the best performance from your Inverter system, batteries should be the same size, type, rating and age. Do not use old or untested batteries.

DC Positive and Negative Wires

- Connect the negative cable from the battery bank negative terminal to the Inverters negative terminal. Mount the DC circuit breaker or fuse assembly and leave open (no power to the GP-ISW). Connect the positive cables from the circuit breaker / fuse to the battery bank and to the Inverters positive terminal (**Note:** DC circuit breaker and fuse not included).
- Ensure the DC wire connections are flush on the surface of the DC terminals and the hardware used to hold these connections are stacked correctly. Verify all DC connections are secured tightly.
- Attach the red and black terminal covers over the Inverters DC connectors and secure them in place with the supplied screws.



3.3.6 DC GROUNDING

To protect against electrical shock hazards the GP-ISW metal chassis must be connected to the DC grounding system. The DC grounding system is sometimes referred to as the earth ground or another designated ground. For example on an RV, the metal frame of the RV is designated as the negative DC ground / RV ground.

The DC ground wire connection on the GP-ISW is used to connect the exposed chassis of the Inverter to the DC grounding system. Use copper wire that is either bare or provided with green insulation. The size of this conductor should be coordinated with the size of the over-current devices used.

DC grounding involves proper grounding of the negative of the battery, the DC panel and the DC side of the GP-ISW. The DC panel is normally used to connect the batteries and distribute DC power to the Inverter and to the other DC loads.

A common earth ground should be used to bond the Inverter, negative bus bar and the negative battery terminal. All connections must be tight against bare metal. Use star washers to penetrate paint and corrosion.

3.4 AC WIRING

The cables linking the GP-ISW to the appliances are the AC cables. The following points must be observed for the AC Wiring

- Review the safety information at the start of this manual before completing any AC wire installation steps.
- All AC Wiring must be approved for the application (RV, Marine, Residential). For RV applications, this may be solid wire in multi-conductor cables, but stranded wire is required if single conductors are used.
- All wiring must be rated to 75°C or higher.
- Do not connect the AC Output to an AC Power source (generator / shore power). Severe damage may occur and will not be covered under the warranty.
- Always use properly rated circuit breakers / fuses.
- Make sure all cables have a smooth bend radius and no kinks are present.

3.4.1 AC OUTPUT INTERFACE

Socket Type (F)	Model
 <p data-bbox="197 469 432 494">North America (GFCI)</p>	<p data-bbox="680 408 922 434">GP-ISW200/400-12/24</p>

3.4.2 GFCI (GROUND FAULT CIRCUIT INTERRUPTION) OUTLETS











Compliance with UL standards requires that Go Power! test and recommend specific GFCIs for use on the AC output of the GP-ISW. GFCIs shall be installed in the AC output wiring system to protect all branch circuits.

A GFCI is a device that de-energizes a circuit when a current exceeds a specified value that is less than that required to open the circuit breaker. GFCIs are intended to protect people from electric shocks and are usually required in wet or damp locations.

The table below lists GFCIs that have been tested and will function properly when connected to the AC output of the GP-ISW.

Manufacturer	Model Number
Cooper Wiring Devices	Type VGF20 Rated 125V, 20A
Leviton Mfg Co Inc	Type 7899-W, Rated 125V, 20A
Hubbell Inc Wiring Device Dev	Type GF20, Rated 125V, 20A

4. OPERATION

Status	LED Signal	Description
Power on	 <p>R=red, O=orange, R=red</p>	Beep twice, LED shows red → orange → green → green
Green		
Normal		LED lights in solid green
Saving mode		LED flashes green intermittently once every 2 seconds.
Orange		
Under voltage alarm		LED flashes orange light slowly with 5 short beeps every 15 seconds
Over voltage		LED flashes orange light every 0.1 seconds
Red		
Over temperature		LED flashes red light quickly twice every 1.6 seconds
O/P short circuit		LED lights red; following two short beeps. Inverter shuts down after two seconds and restart 3 times.
O/P over load		LED lights red; following two short beeps. Inverter shuts down after 3 minutes and restart 3 times.
Shut down under voltage		LED flashes red light every 0.4 seconds, then inverter shuts down.
Shut down over voltage		LED flashes red light every 0.1 seconds, then inverter shut down.
Fan alarm		LED flashes red light slowly once and quickly twice every 1.6 seconds

GP-ISW-400 LED signal

Status	LED Signal	Description
Green		
Normal or Power ON	—————	LED lights in solid green
Orange		
Over load	- - - - -	LED fast blink with two long beeps
Over temp. / Under temp. (Heat sink temp. over 80°C or under -20°C)	- - - - -	LED slow blink
Red		
Over current / Over load (AC output short-circuit and over load)	—————	LED lights in solid red with one short beep
Over voltage (Input DC voltage over spec.)	- - - - -	LED fast blink
Under voltage (Input DC voltage under spec.)	- - - - -	LED slow blink with one long beep & two short beeps

4.1 FINAL INSPECTION

1. Verify all cables / conduit runs are secured with zip ties or other non-conductive cable clamps to prevent damage from vibration.
2. Ensure all cables that pass through walls, bulkheads or any other openings are protected against abrasion by using strain reliefs and/or grommets.
3. Check all AC, DC and ground connections are securely tightened, and if required covered with suitable anti-seizing grease.
4. Check all connections are secure in the main and sub panels - replace all covers.
5. If required by code, have the installation inspected by an electrical inspector.

4.2 TESTING THE INSTALLATION

1. Apply battery power to the inverter by engaging the fuse or switching the breaker to the ON position.
2. Disconnect all AC loads from the inverter.
3. Press the ON/OFF button. The inverter will carry out self-diagnosis and the LED's will also appear (various colors).
4. Connect a 25W light bulb to the inverter output and verify it comes on and shines normally.
5. Press the ON/OFF button. The inverter and LED lights will turn off.

4.3 CONNECTING THE AC LOADS

Calculate the total power consumption of the output load. Make sure that the total power consumption does not exceed the rated power. If the total power consumption is higher than the rated power of the inverter, remove the non-critical loads until the total power consumption is below the rated power.

4.4 LED INDICATORS

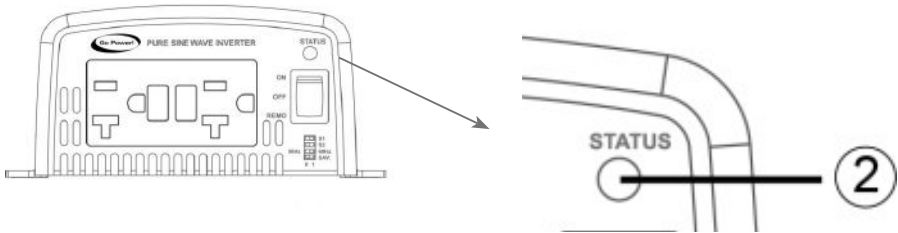

4.4.1 INPUT VOLTAGE LEVEL



LED status	DC 12V	DC 24V
Red	< 11.0V	< 22.0V
Orange	11.0 ~ 11.5V	22.0 ~ 23.0V

Green	11.5 ~ 15.0V	23.0 ~ 30.0V
Orange	15.0 ~ 15.5V	30.0 ~ 31.0V
Red	>15.5V	>31.0V

4.4.2 INVERTER STATUS TO DISPLAY FAULT CONDITION



LED status	Status	Recovery point
Green	Normal	
Red	Over Current Protection / Over Load Protection (AC output short-circuit and over load)	
Red Blink	Under Voltage Protection (Input DC voltage under spec)	12.5V @ DC12V system 25V @ DC24V system
Red Fast Blink	Over Voltage Protection (Input DC voltage over spec)	14.5V @ DC12V 29V @ DC24V system
Orange	Device startup process abnormal	-
Orange Fast Blink	Under Temperature Protection (Heat sink temp. under -20°C)	> 0°C (heat sink temperature)
Orange Slow Blink	Over Temperature Protection (Heat sink temp. over 80°C)	< 60°C (heat sink temperature)

4.5 FUNCTION SWITCH

4.5.1 OUTPUT VOLTAGE SELECTION (S1&S2)

Output Voltage	S1	S2
100V	OFF	OFF
110V	OFF	ON
115V	ON	OFF
120V	ON	ON

4.5.2 OUTPUT FREQUENCY SELECTION (S3)

Frequency	S3
50Hz	OFF
60Hz	ON

4.6 POWER SAVING SELECTION (S4)

Saving Function	S4
Power Saving OFF	OFF
Power Saving ON	ON

4.7 SHUTDOWN CONDITIONS

GP-ISW200 /400	Over Voltage (DC)		Under Voltage Alarm	Under Voltage (DC)	
	Shutdown	Restart		Shutdown	Restart
12V	16V ± 0.3V	14.5V± 0.3V	10.5V ± 0.3V	10V ± 0.3V	12.5V± 0.3V
24V	33V ± 0.5V	29V ± 0.5V	21V± 0.5V	20V ± 0.5V	25V ± 0.5V

GP-ISW200	Over Temperature Protection	
	Shutdown	Restart
12V	90 +/- 3°C	50 +/- 3°C
24V		

GP-ISW400	Over Temperature Protection	
	Shutdown	Restart
12V	80°C	60°C
24V		



5. WARRANTY RETURN PROCEDURE

The Go Power! warranty is valid against defects in materials and workmanship for the specific product warranty period. It is not valid against defects resulting from, but not limited to:

- Misuse and/or abuse, neglect or accident
- Exceeding the unit's design limits
- Improper installation, including, but not limited to, improper environmental protection and improper hook-up
- Acts of God, including lightning, floods, earthquakes, fire, and high winds
- Damage in handling, including damage encountered during shipment

A warranty shall be considered void if the warranted product is in any way opened or altered. The warranty will be void if any eyelet, rivets, or other fasteners used to seal the unit are removed or altered, or if the unit's serial number is in any way removed, altered, replaced, defaced, or rendered illegible.

Warranty Return Procedure

Before contacting Go Power! customer service department, please read the "frequently asked questions" section of our website to troubleshoot the problem. If trouble persists:

1. Call your Go Power!® Technical Support team (1-866-247-6527) or
2. Return defective product to place of purchase

Unless approved by Go Power! Management, all product shipped collect to Go Power! will be refused. Test items or items that are not under warranty, or units that are not defective, will be charged a minimum bench charge of (\$50.00 US) plus taxes and shipping. A 15% restocking charge will be applied on goods returned and accepted as "new" stock.

An RMA number (Return Materials Authorization number) from Go Power! Customer Service is required prior to returning any Go Power! Products. Go Power! reserves the right to refuse any items sent to Go Power! without an associated RMA number. To obtain an RMA number, please contact customersupport@gpelectric.com or Telephone Toll Free for US & Canada 1-866-247-6527.

Out of Warranty

Go Power! electronic products are non-repairable, Go Power! does not perform repairs on its products nor does it contract out those repairs to a third party. Go Power! does not supply schematics or replacement parts for any of its electronic products.

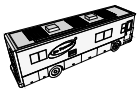

Product E.O.L (End of life) Information



This product required the extraction and use of natural resources. It may contain substances that could be harmful to the environment or human health if improperly handled at the product's end of life. In order to avoid release of such substances into the environment and to reduce the use of natural resources, we encourage you to recycle the GP-ISW in an appropriate way that will ensure most of the materials are reused or recycled appropriately.

DO NOT DISPOSE OF THIS PRODUCT WITH NORMAL GARBAGE

The easiest way to recycle the GP-ISW is to take the unit to a local **certified** e-waste (electronics waste) recycling centre. Knowing for sure if your appliances are being recycled properly is tricky. If you're in doubt just ask. Recyclers that are certified should gladly show you their certification. If the re-cycler is certified, chances are very high that they are recycling responsibly.

To find your local e-waste centre please contact your local municipality. The following website also has information on local recycling centres: www.earth911.com/recycling-center-search-guides

If you have no local certified e-waste recycling centre, the GP-ISW can be disassembled manually and recycled responsibly. A Phillips screwdriver is required to disassemble the GP-ISW. Note: The GP-ISW should only be disassembled at the end of its service life. Go Power! provides no spare parts for the GP-ISW.

Local recycling centres can be found here;
www.earth911.com/recycling-center-search-guides

© 2018 Go Power!®

Worldwide Technical Support and Product Information gpelectric.com

Go Power! Headquarters
201-710 Redbrick St, Victoria, BC Canada V8T 5J3
Tel: 1.866.247.6527



82654_MAN_ISW200-400_RevA