

GARMIN®

**ECHOMAP™ ULTRA 2
100/120/160 SERIES**

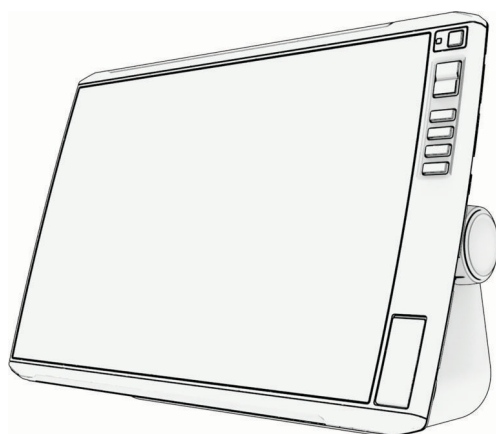

**Owner's
Manual**

Table of Contents

Introduction..... 11

Front View.....	11
Device Keys.....	11
Connector View ECHOMAP™ Ultra 2 10Xsv and 12Xsv models.....	12
Connector View ECHOMAP™ Ultra 2 16Xsv models.....	12
Tips and Shortcuts.....	13
Accessing Owner's Manuals on the Chartplotter.....	13
Accessing the Manuals from the Web.....	13
Garmin® Support Center.....	13
Inserting Memory Cards.....	14
Acquiring GPS Satellite Signals.....	14
Selecting the GPS Source.....	14

Customizing the Chartplotter..... 15

Menu Bar.....	15
Hiding and Showing the Menu Bar..	15
Home Screen.....	15
Rearranging the Category Items.....	16
Assigning a Shortcut Key.....	16
Setting the Vessel Type.....	16
Adjusting the Backlight.....	16
Adjusting the Color Mode.....	16
Adjusting the Color Theme.....	16
Enabling Screen Lock.....	17
Turning On the Chartplotter Automatically.....	17
Automatically Turning Off the System.....	17
Customizing Pages.....	17
Customizing the Layout of a Combination Page.....	17
Creating a New Combination Page..	17
Deleting a Combination Page.....	18
Customizing the Data Overlays.....	18
Customizing the Startup Screen.....	18
Presets.....	18
Managing Presets.....	19
Saving a New Preset.....	19

Voice Control..... 20

Changing the Voice Control Language on a ECHOMAP™ Ultra 2 16Xsv Chartplotter.....	20
Supported Headsets.....	20
Pairing a Wireless Headset with a ECHOMAP™ Ultra 2 16Xsv Chartplotter.....	20
Using a Wireless Headset with a ECHOMAP™ Ultra 2 16Xsv Chartplotter.....	20
Pairing a Garmin® Watch with a ECHOMAP™ Ultra 2 16Xsv Chartplotter for Voice Control.....	20
Enabling Boat Mode on a Garmin® Watch.....	21
Using a Garmin® Watch with a ECHOMAP™ Ultra 2 16Xsv Chartplotter for Voice Control.....	21
Chartplotter Voice Commands.....	21

ActiveCaptain® App..... 26

ActiveCaptain® Roles.....	26
Getting Started with the ActiveCaptain® App.....	26
Updating Software with the ActiveCaptain® App.....	26
Updating Charts with ActiveCaptain® ..	27
Chart Subscriptions.....	27

Wireless Sharing..... 28

Setting Up the Wi-Fi® Network.....	28
Connecting Two Compatible ECHOMAP™ Devices to Share User Data and Sonar.....	28
Connecting a Wireless Device to the Chartplotter.....	29
Managing the Wi-Fi® Network.....	29
Wireless Wind Sensor.....	29
Connecting a Wireless Sensor to the Chartplotter.....	29
Adjusting the Wind Sensor Orientation.....	29
Viewing Boat Data on a Garmin® Watch.....	29
Pairing a Garmin® Watch to Control a Garmin Chartplotter.....	30

Enabling Boat Mode on a Garmin®
Watch..... 30

Charts and 3D Chart Views..... 31

Detailed Charts..... 31
 Activating a Marine Chart
 Subscription..... 31
 Purchasing a Chart Subscription with
 ActiveCaptain® 31
 Renewing Your Subscription..... 32
Navigation Chart and Fishing Chart.... 32
 Chart Symbols..... 32
 Zooming In and Out Using the
 Touchscreen..... 32
 Measuring a Distance on the
 Chart..... 32
 Creating a Waypoint on the Chart... 33
 Viewing Location and Object
 Information on a Chart..... 33
 Viewing Details about Navaids..... 33
 Navigating to a Point on the Chart.. 33
Premium Chart Features..... 33
 Fish Eye 3D Chart View..... 34
 Viewing Tide Station Information.... 34
 Showing Satellite Imagery on the
 Navigation Chart..... 35
 Viewing Aerial Photos of
 Landmarks..... 35
Automatic Identification System..... 36
 AIS Targeting Symbols..... 36
 Heading and Projected Course of
 Activated AIS Targets..... 37
 Viewing a List of AIS Threats..... 37
 Activating a Target for an AIS
 Vessel..... 37
 Setting the Safe-Zone Collision
 Alarm..... 38
 AIS Aids to Navigation..... 38
 Turning Off AIS Reception..... 39
Chart Menu..... 39
 Chart Layers..... 40
 Chart Settings..... 42
 Fish Eye 3D Settings..... 43
Supported Maps..... 43

Garmin Quickdraw™ Contours Mapping..... 44

Mapping a Body of Water Using the
Garmin Quickdraw™ Contours
Feature..... 44
Adding a Label to a Garmin Quickdraw™
Contours Map..... 44
Garmin Quickdraw™ Community..... 44
 Connecting to the Garmin Quickdraw™
 Community with ActiveCaptain® 45
Garmin Quickdraw™ Contours
Settings..... 45

Navigation with a Chartplotter..... 46

Basic Navigation Questions..... 46
Route Color Coding..... 47
Destinations..... 47
 Searching for a Destination by
 Name..... 47
 Selecting a Destination Using the
 Navigation Chart..... 47
 Searching for a Marine Services
 Destination..... 47
 Setting and Following a Direct Course
 Using Go To..... 47
 Stopping Navigation..... 48
Waypoints..... 48
 Marking Your Present Location as a
 Waypoint..... 48
 Creating a Waypoint at a Different
 Location..... 48
 Marking an MOB Location..... 48
 Projecting a Waypoint..... 48
 Viewing a List of all Waypoints..... 48
 Editing a Saved Waypoint..... 48
 Moving a Saved Waypoint..... 49
 Browsing for and Navigating to a
 Saved Waypoint..... 49
 Deleting a Waypoint or an MOB..... 49
 Deleting All Waypoints..... 50
Routes..... 50
 Creating and Navigating a Route From
 Your Present Location..... 50
 Creating and Saving a Route..... 50
 Viewing a List of Routes and Auto
 Guidance Paths..... 50
 Editing a Saved Route..... 50
 Finding and Navigating a Saved
 Route..... 51

Browsing for and Navigating Parallel to a Saved Route.....	51
Initiating a Search Pattern.....	51
Deleting a Saved Route.....	52
Deleting All Saved Routes.....	52
Auto Guidance.....	52
Setting and Following an Auto Guidance Path.....	52
Creating and Saving an Auto Guidance Path.....	52
Adjusting a Saved Auto Guidance Path.....	52
Canceling an Auto Guidance Calculation in Progress.....	53
Setting a Timed Arrival.....	53
Auto Guidance Path Configurations.....	53
Tracks.....	54
Showing Tracks.....	54
Setting the Color of the Active Track.....	54
Saving the Active Track.....	54
Viewing a List of Saved Tracks.....	54
Editing a Saved Track.....	54
Saving a Track as a Route.....	55
Browsing for and Navigating a Recorded Track.....	55
Deleting a Saved Track.....	55
Deleting All Saved Tracks.....	55
Retracing the Active Track.....	55
Clearing the Active Track.....	55
Managing the Track Log Memory During Recording.....	55
Configuring the Recording Interval of the Track Log.....	55
Boundaries.....	56
Creating a Boundary.....	56
Converting a Route to a Boundary... ..	56
Converting a Track to a Boundary... ..	56
Editing a Boundary.....	56
Setting a Boundary Alarm.....	56
Disabling all Boundary Alarms.....	57
Deleting a Boundary.....	57
Deleting All Saved Waypoints, Tracks, Routes, and Boundaries.....	57

Sailing Features.....58

Setting the Vessel Type for Sailing Features.....	58
Sail Racing.....	58
Starting Line Guidance.....	58
Starting the Race Timer.....	59
Stopping the Race Timer.....	59
Setting the Distance between the Bow and the GPS Antenna.....	59
Sailing Navigation Chart Presets.....	60
Laylines Settings.....	60
Polar Tables.....	60
Selecting a Preloaded Polar Table.. ..	61
Viewing Polar Table Details.....	61
Showing Polar Data in Data Fields.. ..	61
Adjusting the Scale of the Polar Table.....	62
Turning Off Polar Table Data.....	62
Steer Assist.....	62
Setting the Keel Offset.....	63
Sailboat Autopilot Operation.....	64
Wind Hold.....	64
Tack and Gybe.....	65
Heading Line and Angle Markers.....	65
Setting the Heading Line and Angle Markers.....	66
Viewing Sailing Vessel Data.....	66
Sonar Fishfinder..... 67	
Stopping the Transmission of Sonar Signals.....	67
Traditional Sonar View.....	67
Split-Frequency Sonar View.....	67
Garmin ClearVü™ Sonar View.....	67
Garmin SideVü™ Sonar View.....	68
SideVü Scanning Technology.....	69
Measuring Distance on the Sonar Screen.....	69
Panoptix™ Sonar Views.....	69
LiveVü Down Sonar View.....	70
LiveVü Forward Sonar View.....	70
RealVü 3D Forward Sonar View.....	71
RealVü 3D Down Sonar View.....	71
RealVü 3D Historical Sonar View....	72
Garmin FrontVü™ Sonar View.....	73
Triple Beam Sonar View.....	74
LiveScope™ Sonar View.....	74

Zooming in a Panoptix™ LiveVü or LiveScope™ Sonar View.....	74	Autopilot.....	89
Perspective View.....	75	Autopilot Configuration.....	89
Flasher View.....	75	Selecting the Preferred Heading Source.....	89
Sonar Views in Combo Screens.....	76	Opening the Autopilot Screen.....	89
Selecting the Transducer Type.....	76	Autopilot Screen.....	90
Selecting a Sonar Source.....	77	Adjusting the Step Steering Increment.....	90
Renaming a Sonar Source.....	77	Setting the Power Saver.....	90
Pausing and Resuming the Sonar Display.....	77	Enabling the Shadow Drive™ Feature.....	90
Paused Sonar Considerations.....	77	Autopilot Overlay Bar.....	91
Viewing Sonar History.....	78	Engaging the Autopilot.....	91
Creating a Waypoint on the Sonar Screen.....	78	Adjusting the Heading Using the Helm.....	91
Adjusting the Level of Detail.....	78	Adjusting the Heading with the Chartplotter in Step Steering Mode.....	91
Adjusting the Color Intensity.....	78	Steering Patterns.....	92
Sonar Setup.....	78	Following the U-Turn Pattern.....	92
Setting the Zoom Level on the Sonar Screen.....	79	Setting Up and Following the Circles Pattern.....	92
Setting the Scroll Speed.....	79	Setting Up and Following the Zigzag Pattern.....	92
Adjusting the Range.....	80	Following the Williamson Turn Pattern.....	92
Sonar Noise Rejection Settings.....	80	Following an Orbit Pattern.....	92
Sonar Appearance Settings.....	80	Setting Up and Following the Cloverleaf Pattern.....	92
Sonar Alarms.....	81	Setting Up and Following a Search Pattern.....	92
Advanced Sonar Settings.....	81	Cancelling a Steering Pattern.....	93
Transducer Installation Settings.....	81	Adjusting the Autopilot Response.....	93
Sonar Frequencies.....	82	Enabling Auto Response.....	93
Turning On the A-Scope.....	82	Low-Speed Autopilot Mode.....	93
Panoptix™ Sonar Setup.....	83	Enabling and Disabling Low-Speed Autopilot Mode.....	93
Adjusting the RealVü Viewing Angle and Zoom Level.....	83	Engaging and Disengaging Low Speed Autopilot Mode.....	93
Adjusting the RealVü Sweep Speed.....	83	Enabling the Autopilot Controls on a Garmin® Watch.....	93
LiveVü Forward and Garmin FrontVü™ Sonar Settings.....	83	Customizing the Autopilot Button Actions.....	94
RealVü Appearance Settings.....	85	Reactor™ Autopilot Remote Control....	94
Panoptix™ Transducer Installation Settings.....	85	Pairing a Reactor™ Autopilot Remote Control With a Chartplotter.....	94
LiveScope and Perspective Sonar Settings.....	86		
LiveScope and Perspective Sonar Setup.....	87		
LiveScope and Perspective Appearance Settings.....	87		
LiveScope and Perspective Layout Settings.....	87		
LiveScope and Perspective Transducer Installation Settings.....	87		

Changing the Functions of the Reactor™ Autopilot Remote Control Action Keys.....	94
Updating the Reactor™ Autopilot Remote Control Software.....	94
Autopilot Keypad.....	95
Function Key Default Actions.....	95
Configuring the Function Keys.....	95
Power Steering Mode.....	95
Enabling Power Steering Mode.....	95
Yamaha® Autopilot.....	96
Yamaha® Autopilot Screen.....	96
Yamaha® Autopilot Overlay Bar.....	97

Force® Trolling Motor Control..... 98

Connecting to a Trolling Motor.....	98
Adding the Trolling Motor Controls to Screens.....	98
Trolling Motor Control Bar.....	98
Reverse Thrust.....	99
Trolling Motor Settings.....	99
Assigning a Shortcut to the Trolling Motor Remote Control Shortcut Keys.....	100
Calibrating the Trolling Motor Compass.....	100
Setting the Bow Offset.....	100
Calibrating the Steering Alignment	100

Digital Selective Calling..... 102

Networked Chartplotter and VHF Radio Functionality.....	102
Turning On DSC.....	102
DSC List.....	102
Viewing the DSC List.....	102
Adding a DSC Contact.....	102
Incoming Distress Calls.....	102
Navigating to a Vessel in Distress.	102
Man-Overboard Distress Calls Initiated from a VHF Radio.....	103
Position Tracking.....	103
Viewing a Position Report.....	103
Navigating to a Tracked Vessel....	103
Creating a Waypoint at the Position of a Tracked Vessel.....	103
Editing Information in a Position Report.....	103

Deleting a Position-Report Call.....	103
Viewing Vessel Trails on the Chart	104
Individual Routine Calls.....	104
Selecting a DSC Channel.....	104
Making an Individual Routine Call..	104
Making an Individual Routine Call to an AIS Target.....	104

Gauges and Graphs..... 105

Viewing the Gauges.....	105
Engine Alert Icons.....	105
Changing the Data Shown in a Gauge.....	105
Customizing the Gauges.....	105
Customizing Engine Gauge and Fuel Gauge Limits.....	106
Selecting the Number of Engines Shown in Gauges.....	106
Customizing the Engines Shown in Gauges.....	106
Enabling Status Alarms for Engine Gauges.....	106
Enabling Some Engine Gauge Status Alarms.....	106
Yamaha® Engine and Motor Gauges..	106
Engine and Motor Function Icons..	107
Engine and Motor Status Icons....	108
Engine and Motor Warning Icons..	108
Setting Up the Gauges.....	108
Mercury® Engine Gauges.....	109
Setting the Fuel Alarm.....	110
Synchronizing the Fuel Data with the Actual Vessel Fuel.....	110
Viewing the Wind Gauges.....	111
Configuring the Sailing Wind Gauge.....	111
Configuring the Speed Source.....	111
Configuring the Heading Source of the Wind Gauge.....	111
Customizing the Close-Hauled Wind Gauge.....	111
Viewing Trip Gauges.....	112
Resetting Trip Gauges.....	112
Viewing Graphs.....	112
Setting the Graph Range and Time Scales.....	112
Disabling Graph Filtering.....	112

Garmin OnBoard™ Man Overboard Engine Cutoff System..... 113

MOB Tag.....	113
Attaching the Band or Carabiner Loop.....	113
MOB Tag Roles.....	114
Turning an MOB Tag On and Off...	115
Checking the Status of an MOB Tag.....	115
Disarming an MOB Tag.....	115
Initiating an MOB Procedure from an MOB Tag Manually.....	116
Replacing the MOB Tag Battery....	116
Configuration.....	116
Adding the MOB Tags Overlay.....	117
Pairing an MOB Tag.....	117
Changing the Role of an MOB Tag.	118
Changing the Name of an MOB Tag.....	118
Changing the Reacquisition Time for an MOB Tag.....	118
Removing an MOB Tag.....	118
Restoring the Garmin OnBoard™ Engine Cutoff System to Factory Default Settings.....	118
Restoring an MOB Tag to Factory Default Settings.....	118
System Bypass.....	119
Bypassing the System From a Chartplotter.....	119
Bypassing the System from the GOS™ 10 Hub.....	119

inReach® Messages..... 121

Connecting an inReach® Device to the Chartplotter.....	121
Receiving Messages.....	121
Replying to a Message.....	121
Sending a Check-In Message.....	122
Starting a New Conversation.....	122
Sending a Quick Message.....	122
Sending a Custom Message.....	122
inReach® SOS Calls.....	122
Sending an inReach® SOS Call.....	123

Communicating with the Garmin Response™ Team During an SOS Call.....	123
Cancelling an inReach® SOS Call...	123
Changing inReach® Tracking Settings.....	123

Digital Switching..... 124

Adding and Editing a Digital Switching Page.....	124
Garmin Boat Switch™.....	124
Configuring the Garmin Boat Switch™ Device.....	124
Configuring Digital Switches for Voice Control.....	125
Using the Bilge Pump Switches....	126
Using Dimmable Lights.....	126

Controlling Third-Party Equipment Installed on Your Boat..... 127

Power-Pole® Anchor System.....	127
Enabling the Power-Pole® Anchor or CHARGE™ Overlay.....	127
Setting Up the Power-Pole® Anchor.....	127
Power-Pole® Overlay.....	127
Power-Pole® Advanced Boat Control.....	128
CHARGE™ Overlay.....	128
Mercury® Troll Control Features.....	129
Adding the Mercury® Troll Control Overlay.....	129
Mercury® Troll Overlay.....	129
Mercury® Cruise Control.....	129
Enabling the Mercury® Cruise Control Overlay.....	129
Mercury® Cruise Control Overlay...	130
Mercury® Engine Details.....	130
Adding the Mercury® Engine Overlay.....	130
Mercury® Engine Overlay.....	130
Enabling the Mercury® Engine Sport Exhaust Setting.....	131
Mercury® Active Trim Control.....	131

Adding the Mercury® Active Trim Overlay.....	131
Mercury® Active Trim Overlay.....	131
Dometic® Optimus® Features.....	131
Activating the Optimus® Overlay Bar.....	131
Optimus® Overlay Bar Overview.....	131
Optimus® Overlay Symbols.....	132
Optimus® Limp Home Mode.....	132

Tide, Current, and Celestial Information..... 133

Tide and Current Overlays.....	133
Adding Tide and Current Overlays.	133
Tide Station Information.....	133
Current Station Information.....	133
Celestial Information.....	134
Viewing Tide Station, Current Station, or Celestial Information for a Different Date.....	134
Viewing Information for a Different Tide or Current Station.....	134
Viewing Almanac Information from the Navigation Chart.....	134

Messages and Warnings..... 135

Viewing Messages and Warnings.....	135
Sorting and Filtering Messages.....	135
Saving Messages to a Memory Card	135
Clearing all Messages and Warnings	135

Media Player..... 136

Opening the Media Player.....	136
Media Player Icons.....	136
Selecting the Media Device and Source.....	136
Adjusting the Volume and Audio Levels.....	136
Adjusting the Volume.....	136
Adjusting the Audio Level.....	136
Muting the Media Volume.....	137
Automatic Volume Adjustment Based on Speed.....	137
Stereo Zones and Groups.....	138
Selecting the Home Zone.....	138
Adjusting the Zone Volume.....	138
Disabling a Speaker Zone.....	138

Creating a Group.....	138
Playing Music.....	139
Browsing for Music.....	139
Setting a Song to Repeat.....	140
Setting All Songs to Repeat.....	140
Setting Songs to Shuffle.....	140
Radio.....	140
Setting the Tuner Region.....	140
Changing the Radio Station.....	140
Changing the Tuning Mode.....	140
Presets.....	140
DAB Playback.....	141
Setting the DAB Tuner Region.....	141
Scanning for DAB Stations.....	141
Changing DAB Stations.....	141
DAB Presets.....	141
SiriusXM® Satellite Radio.....	142
Locating a SiriusXM® Radio ID.....	142
Activating a SiriusXM® Subscription.....	142
Customizing the Channel Guide....	142
Saving a SiriusXM® Channel to the Presets List.....	142
Parental Controls.....	143
Setting the Device Name.....	143
Updating the Media Player Software.	143

Configuring a Stereo from the Chartplotter..... 144

LED Lighting Control..... 145

LED Light Controller Configuration...	145
Initializing Connected LED Lights..	145
Renaming an LED Light.....	145
Associating LED Lights with an Audio Zone.....	146
Renaming an LED Lighting Controller.....	146
Removing an LED Lighting Controller.....	146
LED Lighting Control Screen.....	146
Turning LED Lights On and Off.....	147
Adjusting LED Light Brightness.....	147
Changing LED Light Color.....	147
Changing LED Light Effects.....	148
Setting LED Lights to React to Music.....	148

LED Light Scenes.....	148
Creating a new LED Light Scene...	149
Editing an LED Light Scene.....	149
Starting an LED Light Scene.....	149
Deleting an LED Light Scene.....	149
LED Light Groups.....	149
Creating and Adding Lights to an LED Light Group.....	149
Editing an LED Light Group.....	150
Renaming an LED Light Group.....	150

HDMI® Out Video Considerations.. 151

Device Configuration..... 152

System Settings.....	152
Sounds and Display Settings.....	152
Satellite Positioning (GPS) Settings.....	152
Station Settings.....	153
Viewing System Software Information.....	153
Viewing E-label Regulatory and Compliance Information.....	153
Preferences Settings.....	153
Units Settings.....	153
Navigation Settings.....	154
Communications Settings.....	155
Viewing Connected Devices.....	155
NMEA 2000® Settings.....	155
Setting Alarms.....	156
Navigation Alarms.....	156
System Alarms.....	156
Sonar Alarms.....	156
Setting the Fuel Alarm.....	157
My Vessel Settings.....	157
Setting the Keel Offset.....	157
Setting the Water Temperature Offset.....	158
Fuel Settings.....	159
Calibrating a Water-Speed Device.	159
Other Vessels Settings.....	159
Restoring the Original Chartplotter Factory Settings.....	160

Sharing and Managing User Data.. 161

Selecting a File Type for Third-Party Waypoints and Routes.....	161
--	-----

Copying User Data from a Memory Card.....	161
Copying All User Data to a Memory Card.....	161
Copying User Data from a Specified Area to a Memory Card.....	161
Updating Built-In Maps with a Memory Card and Garmin Express™	162
Backing Up Data to a Computer.....	162
Restoring Backup Data to a Chartplotter.....	162
Saving System Information to a Memory Card.....	162

Appendix..... 163

Device Care.....	163
Cleaning the Screen.....	163
ActiveCaptain® and Garmin Express™	163
Garmin Express™ App.....	163
Installing the Garmin Express™ App on a Computer.....	163
Registering Your Device Using the Garmin Express™ App.....	164
Updating Your Charts Using the Garmin Express™ App.....	164
Software Updates.....	165
Viewing Images on a Memory card... 166	
Screenshots.....	166
Capturing Screenshots.....	166
Copying Screenshots to a Computer.....	166
Troubleshooting.....	166
My device will not acquire GPS signals.....	166
My device will not turn on or keeps turning off.....	166
My device is not creating waypoints in the correct location.....	167
Viewing E-label Regulatory and Compliance Information.....	167
Specifications.....	167
ECHOMAP™ Ultra 2 10Xsv and 12Xsv models.....	167
ECHOMAP™ Ultra 2 16Xsv models.	168
Recommended Startup Image Dimensions.....	169
Network Interfaces and Services...	169

NMEA 2000® PGN Information..... 169
联系信息..... 171

Introduction

⚠ WARNING

See the *Important Safety and Product Information* guide in the product box for product warnings and other important information.

All route and navigation lines displayed on the chartplotter are only intended to provide general route guidance or to identify proper channels, and are not intended to be precisely followed. Always defer to the navais and conditions on the water when navigating to avoid groundings or hazards that could result in vessel damage, personal injury, or death.

Not all features are available on all models.

The Garmin® website at support.garmin.com presents up-to-date information about your product. The support pages will provide answers to frequently asked support questions, and you can download software and chart updates. There is also contact information to Garmin support should you have any questions.

Front View

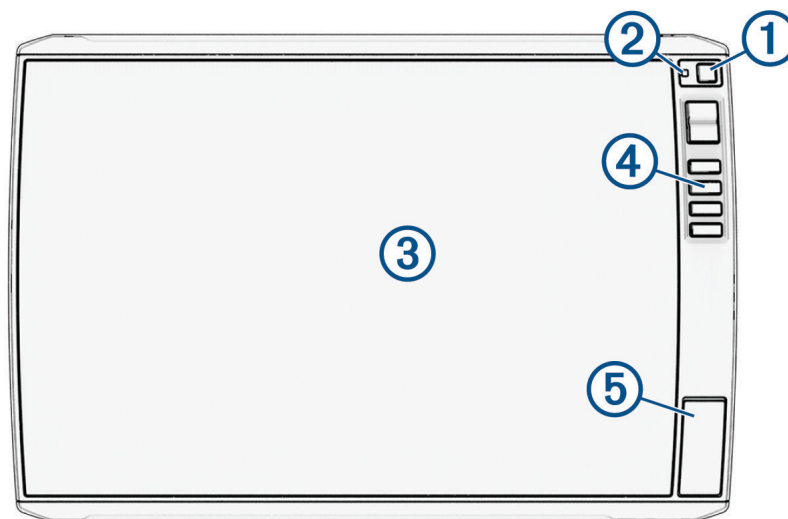

①	Power key
②	Automatic backlight sensor
③	Touchscreen
④	Shortcut keys
⑤	microSD® memory card slots

Device Keys

⏻	Turns on and off the device when held.
	Opens a shortcut menu to backlight, color mode, and sonar transmission when quickly pressed and released. The shortcut menu also shows the autopilot controls if the chartplotter is connected to a compatible autopilot system.
	Scrolls through the brightness levels when pressed repeatedly.
1 2 3 4	Assigns a shortcut key to the active screen when held. Opens the assigned screen when pressed.

Assigning a Shortcut Key

You can quickly open commonly used screens by assigning a shortcut key. You can create a shortcut to screens such as sonar screens and charts.

- 1 Open a screen.
- 2 Hold a shortcut key, and select **OK**.

Connector View ECHOMAP™ Ultra 2 10Xsv and 12Xsv models

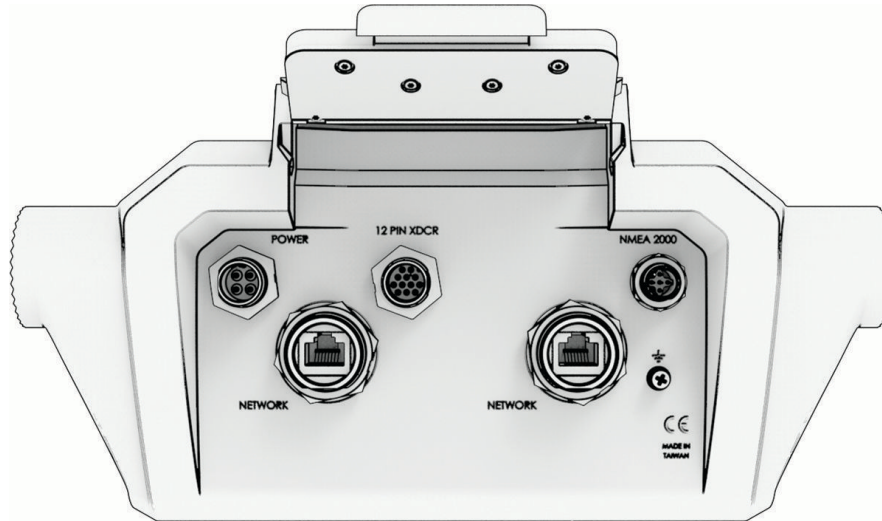

Label	Description
POWER	Power cable port
12 PIN XDCR	12-pin transducer
NMEA 2000	NMEA 2000® network
NETWORK	Garmin® network cable port for connection to compatible Panoptix™, GCV™, and ECHOMAP devices NOTE: This device is not compatible with some Garmin Marine Network devices such as GPSMAP®, GSD™, and radar devices.
	Ground screw

NOTICE

To prevent corrosion of the metal contacts, cover unused connectors with weather caps.

For best performance and to prevent corrosion, insert the cable connector fully into the port and turn the locking ring clockwise to tighten it. If the split-collar locking ring is not installed, you must install it.



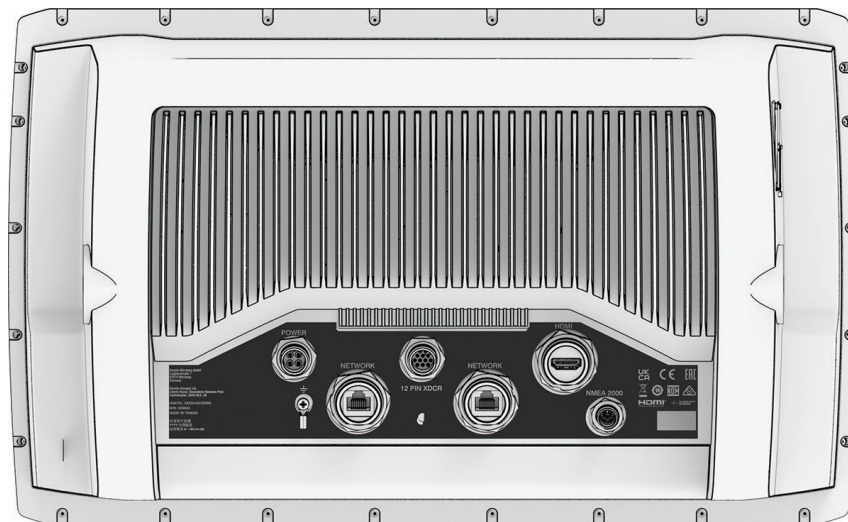







Connector View ECHOMAP™ Ultra 2 16Xsv models





POWER	Power
12 PIN XDCR	12-pin transducer
HDMI	HDMI® video out
	Ground screw

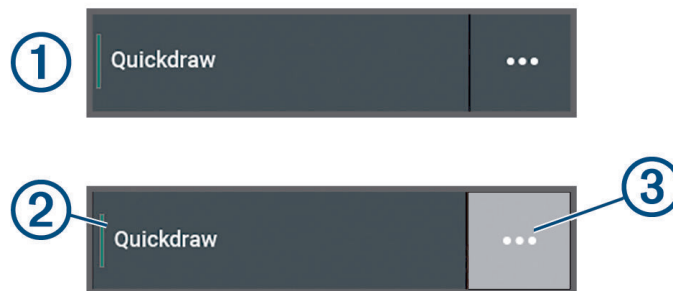

NETWORK	Garmin® network cable port for connection to compatible LiveScope™, GCV™, and ECHOMAP devices NOTE: This device is not compatible with some Garmin Marine Network devices such as GPSMAP®, GSD™, and radar devices.
NMEA 2000	NMEA 2000® network

Tips and Shortcuts

- Press  to turn on the chartplotter.
- From any screen, press  repeatedly to scroll through the brightness levels, if available. This can be helpful when the brightness is so low you cannot see the screen.
- Select **Home** from any screen to open to the home screen.
- Select  to open additional settings about that screen.
- Select  to quickly add a toolbar overlay to the current page.
- Select  to close the menu when finished.
- Press  to open additional options, such as adjusting the backlight.
- Press , and select **Power > Turn Off System**, or hold  until the **Turn Off System** bar fills to turn off the chartplotter, when available.
- Press , and select **Power > Sleep Station** to set the chartplotter to standby mode, when available.
To exit standby mode, select .
- Depending on the features of your chartplotter, not all feature buttons are visible are on the home screen. Swipe right or left to view the additional feature buttons.
- On some menu buttons, select the button  to enable the option.



A green light on an option indicates the option is enabled .

- When available, select   to open the menu.

Accessing Owner's Manuals on the Chartplotter

- 1 Select  > **Owner's Manual**.
- 2 Select a manual.
- 3 Select **Open**.

Accessing the Manuals from the Web

You can get the latest owner's manual and translations of manuals from the Garmin® website. The owner's manual includes instructions for using device features and accessing regulatory information.

- 1 Go to garmin.com/manuals/echomap_ultra_2.
- 2 Select the *Owner's Manual*.

A web manual opens. You can download the entire manual by selecting Download PDF.

Garmin® Support Center

Go to support.garmin.com for help and information, such as product manuals, frequently asked questions, videos, software updates, and customer support.

Inserting Memory Cards

As of software version 34.00, this device supports two microSD® memory cards up to 1 TB, formatted to exFAT with speed class 10 or higher.

NOTE: When you insert a new memory card into the chartplotter, the chartplotter starts writing private information onto the newly-added card.

- 1 Open the access flap or door ① on the front of the chartplotter.

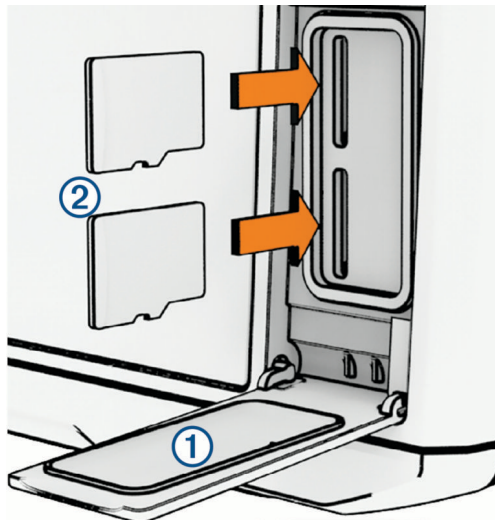

- 2 Fully insert the memory card ②.
- 3 Clean and dry the gasket and door.

NOTICE

To prevent corrosion, be sure the memory card, gasket, and door are thoroughly dry before closing the door.

- 4 Close the door.

Acquiring GPS Satellite Signals

The device may need a clear view of the sky to acquire satellite signals. The time and date are set automatically based on the GPS position.

- 1 Turn on the device.
- 2 Wait while the device locates satellites.
It may take 30 to 60 seconds to acquire satellite signals.

To view the GPS satellite signal strength, select **⚙️ > System > Satellite Positioning**.

If the device loses satellite signals, a flashing question mark appears over the boat position indicator (📍) on the chart.

For more information about GPS, go to [garmin.com/aboutGPS](https://www.garmin.com/aboutGPS). For help acquiring satellite signals, see [My device will not acquire GPS signals, page 166](#).

Selecting the GPS Source

You can select your preferred source for GPS data, if you have more than one GPS source.

- 1 Select **⚙️ > System > Satellite Positioning > Source**.
- 2 Select the source for GPS data.

Customizing the Chartplotter

Menu Bar

The menu bar along the bottom of the screen provides access to many functions of the chartplotter, the options menu, and the home screen.

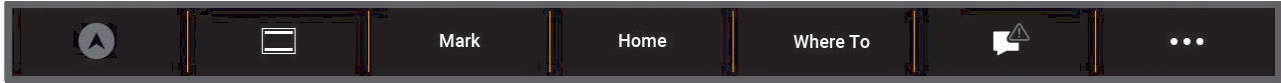

	Engages and disengages the autopilot (when connected to a compatible autopilot system)
	Allows you to add a toolbar overlay to the current page
Mark	Creates a waypoint at your location
Home	Opens the home screen TIP: Touch and drag to scroll through the home-screen items.
Where To	Opens a menu to access navigation features
	This is shown when there are no active alerts or warnings to resolve. Opens a menu to view warnings and alerts and to access other communication such as AIS and DSC information.
	Replaces the when there is an active alert or warning to view. TIP: The icon changes color to indicate severity.

Hiding and Showing the Menu Bar

You can hide the menu bar automatically to make more screen space available.

- 1 Select **Settings > Preferences > Menu Bar Display > Auto**.
After a short period of time on a main page, such as a chart, the menu bar collapses down.
- 2 Swipe the screen from the bottom up to show the menu bar again.

Home Screen

The home screen is an overlay that provides access to all of the features in the chartplotter. The features are dependent on the accessories you have connected to the chartplotter. You may not have all of the options and features discussed in this manual.

When viewing any screen, you can return to the home screen by selecting Home.

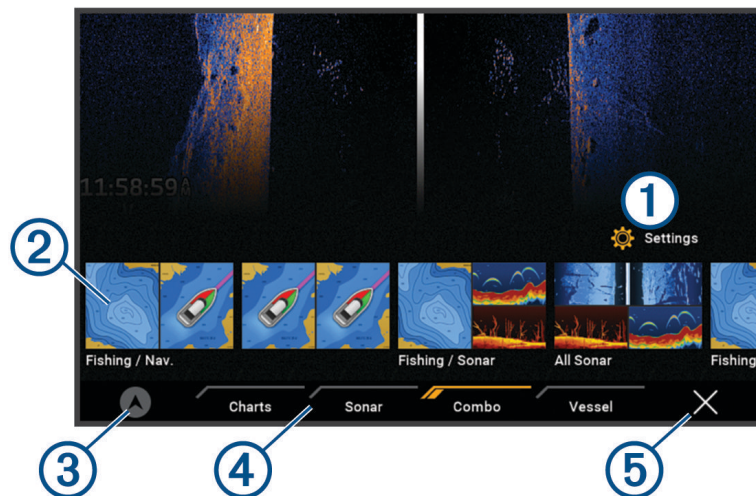

①	Settings menu button
②	Features buttons

③	Present time, present depth, or autopilot control button
④	Category tabs
⑤	Closes the home screen and returns to the previously open page

The categories tabs provide quick access to the main features of your chartplotter. For example, the Sonar tab displays the views and screens related to the sonar feature.

TIP: To view the available categories tabs, you may need to hold and drag a tab to scroll.

When multiple displays are installed on the Garmin BlueNet™ network or Garmin® Marine Network, you can group them together into a station. A station enables the displays to work together, instead of as several separate displays. You can customize the layout of the screens on each display, making each screen different on each display. When you change the layout of a screen in one display, the changes appear on only that display. When you change the name and symbol of the layout, those changes appear on all displays in the station, to maintain a consistent appearance.

Rearranging the Category Items

You can customize the screen by rearranging the items in the categories.

- 1 Select a category to customize, such as **Charts**
- 2 Hold the button you want to move, such as **Nav. Chart**, until the menu appears.
- 3 Select **Rearrange**.
Arrows appear on the feature buttons.
- 4 Reselect the button to move.
- 5 Select the new location for the button.
- 6 Repeat until you finish customizing the screen.
- 7 Select **Back** or **Close** when finished.

Assigning a Shortcut Key

You can quickly open commonly used screens by assigning a shortcut key. You can create a shortcut to screens such as sonar screens and charts.

- 1 Open a screen.
- 2 Hold a shortcut key, and select **OK**.

Setting the Vessel Type

You can select your boat type to configure the chartplotter settings and to use features customized for your boat type.



- 1 Select  > **My Vessel** > **Vessel Type**.
- 2 Select an option.

Adjusting the Backlight

- 1 Select  > **System** > **Sounds and Display** > **Backlight**.
- 2 Adjust the backlight.

TIP: From any screen, press  repeatedly to scroll through the brightness levels. This can be helpful when the brightness is so low you cannot see the screen.

Adjusting the Color Mode

- 1 Select  > **System** > **Sounds and Display** > **Color Mode**.
TIP: Select  > **Color Mode** from any screen to access the color settings.
- 2 Select an option.

Adjusting the Color Theme

You can change the highlight and accent color used on most chartplotter screens.

- 1 Select  > **System** > **Sounds and Display** > **Color Theme**.
- 2 Select an option.

Enabling Screen Lock

For anti-theft protection and to prevent unauthorized use of your device, you can enable the Screen Lock feature which requires a PIN (Personal Identification Number). When enabled, you must enter the PIN to unlock the screen each time you turn on the device. You can set up recovery questions and answers as prompts in case you forget the PIN.

NOTICE



If you enable the Screen Lock feature, Garmin® Support cannot retrieve the PIN or access your device. It is your responsibility to provide the PIN to anyone authorized to use the vessel.

- 1 Select  > **System** > **Sounds and Display** > **Screen Lock** > **Setup**.
 - 2 Enter a memorable numeric PIN of 6 digits.
 - 3 Reenter the PIN to verify.
 - 4 When prompted, choose and answer three PIN recovery questions.
- You can Disable or Reset the PIN and recovery questions as needed.

Turning On the Chartplotter Automatically

You can set the chartplotter to turn on automatically when the power is applied. Otherwise, you must turn on the chartplotter by pressing .

Select  > **System** > **Auto Power Up**.

When Auto Power Up is On, and the chartplotter is turned off using , and power is removed and reapplied within less than two minutes, you may need to press  to restart the chartplotter.

Automatically Turning Off the System

You can set the chartplotter and the whole system to turn off automatically after it has been asleep for the selected length of time. Otherwise, you must press and hold  to turn off the system manually.

- 1 Select  > **System** > **Auto Power Off**.
- 2 Select an option.

Customizing Pages

Customizing the Layout of a Combination Page

You can customize the layout and data shown in the combination pages.

- 1 Open a combination page to customize.
- 2 Select  > **Edit Combo**.
- 3 Select an option:
 - To change the name, select **Name**, enter a new name, and select **Done**.
 - To change the number of functions shown and the layout of the screen, select **Layout**, and select an option.
 - To change the function of a portion of the screen, select the window to change, and select a function from the list on the right.
 - To change how the screens are split, drag the arrows to a new location.
 - To change the data shown on the page and additional data bars, select **Overlays**, and select an option.

TIP: While viewing a screen with data overlay, hold an overlay box to quickly change the data in it.

Creating a New Combination Page

You can create a custom combination page to suit your needs.

- 1 Select **Combo** > **Add Combo**.
- 2 Select a window.
- 3 Select a function for the window.
- 4 Repeat these steps for each window of the page.
- 5 Hold a window to rearrange it.
- 6 Hold a data field to select new data.
- 7 Select **Layout**, and select a layout.

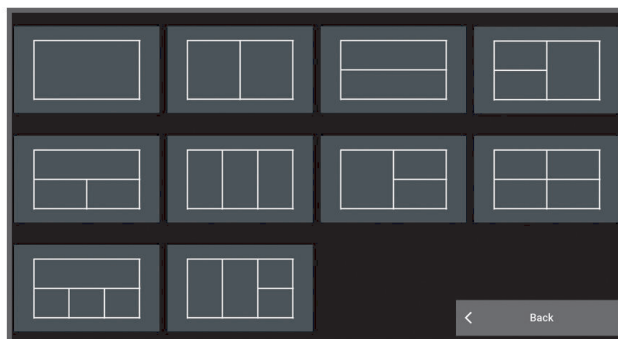

- 8 Select **Name**, enter a name for the page, and select **Done**.
- 9 Select **Overlays**, and select which data to show.
- 10 Select **Done** when you have finished customizing the page.

Deleting a Combination Page

- 1 Select **Combo**.
- 2 Press and hold a combination page to delete.
- 3 Select **Delete Combo > Yes**.

Customizing the Data Overlays

You can customize the data in the data overlays shown on a screen.

- 1 Select an option based on the type of screen you are viewing:
 - From a full screen view, select **••• > Edit Overlays**.
 - From a combination screen, select **••• > Edit Combo > Overlays**.

TIP: To quickly change the data shown in an overlay box, hold the overlay box.
- 2 Select an item to customize the data and data bar:
 - To show the data overlays, select **Data**, select the location, and select **Back**.
 - To change the data shown in an overlay box, select the overlay box, select the new data to show, and select **Back**.
 - To customize the information shown when navigating, select **Navigation**, and select an option.
 - To turn on other data bars, select **Top Bar**, **Bottom Bar**, **Left Bar**, or **Right Bar**, and select the necessary options.
- 3 Select **Done**.



Customizing the Startup Screen

You can personalize the image that is displayed when the chartplotter is turning on. For the best fit, the image should be 50 MB or less and conform to the recommended dimensions ([Recommended Startup Image Dimensions](#), page 169).

- 1 Insert a memory card that contains the image you want to use.
- 2 Select **⚙ > System > Sounds and Display > Startup Image > Select Image**.
- 3 Select the memory card slot.
- 4 Select the image.
- 5 Select **Set as Startup Image**.

The new image is shown when turning on the chartplotter.

Presets

A preset is a collection of settings that optimize the screen or view. You can use particular presets to optimize groups of settings for your activity. For example, some settings might be optimal for when you are fishing, and

others might be optimal for when you are cruising. Presets are available on some screens, such as charts, sonar views, and radar views.

To select a preset for a compatible screen, select **☰ > ⚙️**, and select the preset.

When you are using a preset and you make changes to the settings or view, you can save the changes to the preset or create a new preset based on the new customizations.

Managing Presets

You can customize the pre-loaded presets and edit presets you created.

- 1 From a compatible screen, select **☰ > ⚙️ > Manage**.
- 2 Select a preset.
- 3 Select an option:
 - To rename the preset, select **Rename**, enter a name, and select **Done**.
 - To edit the preset, select **Edit**, and update the preset.
 - To delete the preset, select **Delete**.
 - To reset all presets to factory settings, select **Reset All**.

Saving a New Preset

After you have customized the settings and view of a screen, you can save the customization as a new preset.

- 1 From a compatible screen, change the settings and view.
- 2 Select **☰ > ⚙️ > Save > New**.
- 3 Enter a name, and select **Done**.
- 4 Select an item, and select **Include** to include or exclude the item from the preset.

Voice Control

You can use your voice to control an ECHOMAP™ Ultra 2 16Xsv chartplotter using a compatible headset.

You can also use your voice to control the chartplotter using a compatible Garmin® watch.

NOTE: Both headsets and Garmin watches connect to the chartplotter using Bluetooth® technology for voice control. Due to Bluetooth standards, this is not a secure, private connection.

Changing the Voice Control Language on a ECHOMAP™ Ultra 2 16Xsv Chartplotter

- 1 From the home screen, select  > **System** > **Sounds and Display** > **Voice Control**.
- 2 Select **Voice Control** > **Voice Language**.
- 3 Select the voice control language.

NOTE: The voice control language can be different than the text language.

Supported Headsets

The ECHOMAP™ Ultra 2 16Xsv chartplotter supports headsets and speakers with the following specifications:

- Bluetooth® hands-free profile version 1.6 or higher
- mSBC audio codec (16 kHz)

Headset manufacturers often list these as "HD Voice" or "Wideband Speech" headsets.

A list of supported headsets is available at support.garmin.com/marine.

Pairing a Wireless Headset with a ECHOMAP™ Ultra 2 16Xsv Chartplotter

- 1 On the chartplotter, select  > **Communications** > **Wireless Devices** > **Voice Control**.
- 2 Select **Search for Devices**.
- 3 Enable pairing mode on your headset according to the manufacturer's instructions.
The name of your headset appears on the chartplotter after it is detected.
- 4 Select the name of your headset.
- 5 Select **Connect**.

Your headset appears on the chartplotter as Paired.

Using a Wireless Headset with a ECHOMAP™ Ultra 2 16Xsv Chartplotter

Before using a wireless headset for voice control, make sure the volume on your headset is sufficient to hear voice responses.



- 1 Say **OK Garmin**.
- 2 Say a command (*Chartplotter Voice Commands, page 21*).
The chartplotter completes the action or provides a voice response.

Pairing a Garmin® Watch with a ECHOMAP™ Ultra 2 16Xsv Chartplotter for Voice Control

Before you can pair a compatible Garmin watch with the chartplotter, you must enable Boat Mode on the watch. You can pair a compatible Garmin watch to the chartplotter to send voice commands and hear replies through the watch. For more information, see the owner's manual for your compatible Garmin watch.

TIP: In addition to voice control, you can also use a compatible Garmin watch to control or view other features on the chartplotter:

- You can use the screen and buttons as a remote control to navigate the user interface (*Pairing a Garmin® Watch to Control a Garmin Chartplotter, page 30*).
- You can control a compatible connected autopilot system (*Enabling the Autopilot Controls on a Garmin® Watch, page 93*).
- You can view important data about your boat, such as depth and speed (*Viewing Boat Data on a Garmin® Watch, page 29*).

- 1 On the chartplotter, select  > **Communications** > **Wireless Devices** > **Wearables** > **Voice Control**.
- 2 Select **Search for Devices**.
- 3 Bring the Garmin watch within range (3 m) of the chartplotter.
- 4 From the watch face, hold , then select **Watch Settings** > **Connectivity** > **Chartplotter** > **Pair New**.
- 5 On the chartplotter, select the name of your watch.

6 Select **Connect**.

Your watch appears on the chartplotter as Paired.

Enabling Boat Mode on a Garmin® Watch

You must enable Boat Mode on your compatible Garmin watch before you can access some of the chartplotter-linked features, such as voice control.

- 1 On the watch, hold  to open the controls menu.
- 2 Select **Boat Mode**.

Using a Garmin® Watch with a ECHOMAP™ Ultra 2 16Xsv Chartplotter for Voice Control

Before you can use Boat Command with your compatible Garmin watch, you must enable Boat Mode on the watch ([Enabling Boat Mode on a Garmin® Watch, page 21](#)).

After you pair a compatible Garmin watch with the chartplotter for voice control, you can speak a command to the watch. The chartplotter hears your voice commands, and speaks a reply through the wearable device, when applicable.

NOTE: Boat Command is available only on select quatix® models.

NOTE: If you do not hear spoken replies through your watch, make sure the volume on the watch is set high enough for the environment.

- 1 On the watch, press , and select the **Boat Command** app.

TIP: If you have not changed the default Hold START function on your watch, you can hold  to open the Boat Command app.

The app opens on the watch, and a line appears just above the menu bar on the chartplotter.

The watch beeps when it is ready for you to speak a command.

- 2 After you hear the beep from the watch, speak a voice command.

The watch beeps again to indicate it has heard the command, and the chartplotter performs the command. If it is applicable to the command, the watch speaks a reply.

Chartplotter Voice Commands

The voice command system is designed to detect natural speech. This is a list of commonly used voice commands, but the device does not require these exact phrases (other than *OK Garmin*). You can try saying variations of these commands in a way that is natural to you.

Voice Wake Word	Function
OK Garmin	Wakes up the chartplotter to listen for voice commands

Voice Help Command	Function
What can I say?	Shows a list of common voice commands

Device and Screen Functions

Voice Command	Function
Show Navigation Chart	Opens the navigation chart screen
Show Fishing Chart	Opens the fishing chart screen
Show Radar	Opens the radar screen
Show Sonar	Opens the sonar screen
Zoom In	Zooms in
Zoom Out	Zooms out
Raise Brightness	Raises the display brightness
Lower Brightness	Lowers the display brightness
Automatic Brightness	Enables automatic display brightness adjustment
Set brightness to 80	Set the brightness to a specified level. For example, you can say "Set brightness to 80," and the brightness level will adjust to 80 percent.
Sleep Display	Puts the display to sleep

Voice Command	Function
Wake Display	Wakes the display
Beeper Off	Disables the chartplotter beeper
Beeper On	Enables the chartplotter beeper
Lock Screen	Locks the chartplotter screen
Unlock Screen	Unlocks the chartplotter screen
Home Screen	Opens the home screen
Screenshot	Captures a screenshot

Vessel Functions

Voice Command	Function
What's the fuel level?	Replies with the present fuel level
What's the engine temperature?	Replies with the present engine temperature
What's the system unit voltage?	Replies with the present system unit voltage

Navigation Functions

Voice Command	Function
Mark Waypoint	Marks a waypoint at your present location
Show Waypoints	Shows a list of all waypoints saved to the device
Clear Active Track	Clears all active track information
What's the distance to the next waypoint?	Replies with the distance to next set waypoint

Media Functions

Voice Command	Function
Show Media Player	Opens the media player
Play Music	Plays the presently selected media
Pause Music	Pauses the presently selected media
Resume	Resumes playing the presently selected media
Previous Track	Returns to the previous track
Next Track	Skips to the next track
Mute	Mutes the media volume
Unmute	Unmutes the media volume
Lower Volume	Lowers the media volume
Raise Volume	Raises the media volume

Weather and Condition Functions

Voice Command	Function
What's the water temperature?	Replies with the present water temperature
What's the air temperature?	Replies with the present air temperature
What's the wind speed?	Replies with the present wind speed
What's the wind direction?	Replies with the present wind direction
When is sunrise?	Replies with the sunrise time for the present location
When is sunset?	Replies with the sunset time for the present location
Tell me the Tide Info	Replies with the present tide information
What time is it?	Replies with the present time
What's the depth?	Replies with the water depth at the present location

Radar Functions

Voice Command	Function
Start Radar Transmission	When a radar is in standby, this starts the radar transmission
Stop Radar Transmission	Stops the radar transmission and places the radar in standby
Enable Echo Trail	Enables the echo trail
Disable Echo Trail	Disables the echo trail
Clear Echo Trail	Clears the echo trail
Increase Radar Gain	Increases the radar gain
Decrease Radar Gain	Decreases the radar gain
Increase Radar Range	Increases the radar range
Decrease Radar Range	Decreases the radar range
Automatic Radar Gain High	Sets the automatic radar gain to the highest setting
Automatic Radar Gain Low	Sets the automatic radar gain to the lowest setting
Automatic Radar Gain Bird	Sets the automatic radar gain to the setting best for locating birds
Manual Radar Gain	Sets the radar gain to the last manual setting
Radar Rain Clutter On	Turns on the rain clutter filter
Radar Rain Clutter Off	Turns off the rain clutter filter
Increase Radar Rain Clutter	Increases the level of the rain clutter setting
Decrease Radar Rain Clutter	Decreases the level of the rain clutter setting
Radar Sea Clutter On	Turns on the sea clutter filter
Radar Sea Clutter Off	Turns off the sea clutter filter
Increase Radar Sea Clutter	Increases the level of the sea clutter setting
Decrease Radar Sea Clutter	Decreases the level of the sea clutter setting
Start MotionScope	Turns on the MotionScope™ feature
Stop MotionScope	Turns off the MotionScope feature

Sonar Functions

Voice Command	Function
Show Traditional Sonar	Opens the traditional sonar screen
Show Clear View	Opens the Garmin ClearVü™ sonar screen
Show Side View	Opens the Garmin SideVü™ sonar screen
Show Live Scope	Opens the LiveScope™ screen
Increase Sonar Gain	Increases the sonar gain level
Decrease Sonar Gain	Decreases the sonar gain level
Sonar Gain Automatic	Sets the sonar gain level to adjust automatically
Increase Sonar Range	Increases the sonar range
Decrease Sonar Range	Decreases the sonar range
Sonar Range Automatic	Sets the sonar range to adjust automatically
Show Front View	Opens the Garmin FrontVü™ sonar screen
Show Live Scope Down	Opens the LiveScope down sonar screen
Show Live Scope Forward	Opens the LiveScope forward sonar screen
Show Live View	Opens the LiveVü sonar screen
Show Live View Down	Opens the LiveVü down sonar screen
Show Live View Forward	Opens the LiveVü forward sonar screen
Show Real View Down	Opens the RealVü down sonar screen
Show Real View Historical	Opens the RealVü historical sonar screen

Voice Command	Function
Show Real View Forward	Opens the RealVü forward sonar screen
Increase Sonar Forward Range	Increases the sonar forward range
Decrease Sonar Forward Range	Decreases the sonar forward range
Sonar Forward Range Automatic	Sets the sonar forward range to adjust automatically
Increase Sonar Depth Range	Increases the sonar depth range
Decrease Sonar Depth Range	Decreases the sonar depth range
Sonar Depth Range Automatic	Sets the sonar depth range to adjust automatically

Garmin® Trolling Motor Functions

Voice Command	Function
Anchor Lock Enabled	Turns on and sets anchor lock
Disengage Anchor Lock	Disengages and turns off anchor lock
Cruise Control On	Turns on and engages cruise control
Disable Cruise	Disengages and turns off cruise control
Set Cruise to 3 Knots	Adjusts the cruise control speed to the spoken value
Turn to Starboard	Uses the trolling motor to turn the vessel to the starboard (right) side
Step Turn Left	Uses the trolling motor to make a small step turn to the left (port)
Set Heading Hold	Engages heading hold
Disable Heading Hold	Disengages heading hold
Jog Left	Adjusts the position of the vessel slightly left (port) when in anchor lock
Bump Port	Adjusts the position of the vessel slightly port (left) when in anchor lock
Jog Front	Adjusts the position of the vessel slightly forward when in anchor lock
Adjust Backward	Adjusts the position of the vessel slightly backward when in anchor lock
Prop On	Turns on the propeller
Motor Off	Turns off the trolling motor
Speed Up	Increases the trolling motor propeller speed one level
Speed Up by 3	Increases the trolling motor propeller speed three levels
Slow down	Decreases the trolling motor propeller speed one level
Set Speed to 10	Sets the trolling motor propeller speed to level 10
Speed to Half	Sets the trolling motor propeller to half of full speed
Speed to Full	Sets the trolling motor propeller to full speed
Turbo	Sets the trolling motor propeller speed to turbo

Before you can use voice commands to control your Garmin trolling motor, you must connect the chartplotter to the trolling motor ([Connecting to a Trolling Motor](#), page 98).

Garmin Boat Switch™ Digital Switching Functions

Voice Command	Function
Turn on the Anchor Lights	Turns on the digital switch assigned to the anchor lights
White Light Off	Turns off the digital switch assigned to the anchor light, which may be referred to as the white light
Start Bilge 1	Turns on the digital switch assigned to the first bilge pump
Stop Bilge 1	Turns off the digital switch assigned to the first bilge pump
Run Bilge 3 Continuously	Turns on and runs the digital switch assigned to the third bilge pump in a manner where it will not turn off automatically
Set Primary Light to 80	Adjusts the brightness of the digital switch assigned to the primary light
Switch off Light 3	Turns off the digital switch assigned to the third light
Turn On Light 1	Turns on the digital switch assigned to the first light

Voice Command	Function
Raise Brightness of Light 2	Steps up the brightness for the digital switch assigned to the second light
Make Lamp 2 Not So Bright	Reduces the brightness of the digital switch assignment to the second light
Sound Horn 1	Triggers the digital switch assigned to the first horn
Stop Primary Horn	Turns off the digital switch assigned to the first horn
Sound Primary Horn for 2 Seconds	Triggers the digital switch assigned to the first horn for two seconds
Turn on Baitwell 1	Turns on the digital switch assigned to the first baitwell or live well pump
Stop Live Well 2	Turns off the digital switch assigned to the first baitwell or live well pump
Continuously Run the Sixth Bait Tank	Turns on and runs the digital switch assigned to the sixth baitwell or live well pump in a manner where it will not turn off automatically
Turn on the Navigation Lights	Turns on the digital switch assigned to the navigation lights
Switch Navigation Lights Off	Turns off the digital switch assigned to the anchor lights
Turn on Steaming Lights	Turns on the digital switch assigned to the steaming lights
Switch the Steaming Lights Off	Turns off the digital switch assigned to the steaming lights

Before you can use voice commands to control functions of your Garmin Boat Switch digital switching system, you must configure your Garmin Boat Switch device to assign identifying information to the switches you want to control using voice control ([Configuring Digital Switches for Voice Control, page 125](#)).

ActiveCaptain® App

⚠ WARNING

This feature allows users to submit information. Garmin® makes no representations about the accuracy, completeness, or timeliness of information submitted by users. Any use or reliance on the information submitted by users is at your own risk.

The ActiveCaptain app provides a connection to your ECHOMAP™ Ultra 2 chartplotter, maps and charts, and the ActiveCaptain community for a connected boating experience.

On your mobile device with the ActiveCaptain app, you can download, purchase, and update maps and charts. You can use the app to easily and quickly transfer user data, such as waypoints and routes, connect to the Garmin Quickdraw™ Contours Community, update device software, and plan your trip.

You can connect to the ActiveCaptain community for up-to-date feedback on marinas and other points of interest.

ActiveCaptain® Roles

Your level of interaction with the ECHOMAP™ Ultra 2 device using the ActiveCaptain app depends on your role.

Feature	Owner	Guest
Register device, built-in maps, and supplemental map cards to account	Yes	No
Update software	Yes	Yes
Automatically transfer Garmin Quickdraw™ contours you have downloaded or created	Yes	No
Automatically transfer user data, such as waypoints and routes	Yes	No
Begin navigating to a specific waypoint or navigating a specific route, and send that waypoint or route to the ECHOMAP Ultra 2 device	Yes	Yes

Getting Started with the ActiveCaptain® App

You can connect a mobile device to the ECHOMAP™ Ultra 2 device using the ActiveCaptain app. The app provides a quick and easy way for you to interact with your ECHOMAP Ultra 2 device and complete such tasks as sharing data, registering, updating the device software.

- 1 From the ECHOMAP Ultra 2 device, select **Vessel > ActiveCaptain**.
- 2 From the **ActiveCaptain** page, select **Wi-Fi Network > Wi-Fi > On**.
- 3 Enter a name and password for this network.
- 4 Insert a memory card in the ECHOMAP Ultra 2 device's card slot (*Inserting Memory Cards, page 14*).
- 5 Select **Set ActiveCaptain Card**.

NOTICE

You might be prompted to format the memory card. Formatting the card deletes all information saved on the card. This includes any saved user data, such as waypoints. Formatting the card is recommended, but not required. Before formatting the card, you should save the data from the memory card onto the device internal memory (*Copying User Data from a Memory Card, page 161*). After formatting the card for the ActiveCaptain app, you can transfer the user data back to the card (*Copying All User Data to a Memory Card, page 161*).

NOTE: Formatting the memory card in the chartplotter retains the format type and is not able to change it. If you want to change a card format from FAT32 to exFAT, for example, you must make that change using a computer or other device before using the card in the chartplotter.

Be sure the card is inserted each time you want to use the ActiveCaptain feature.

- 6 From the application store on your mobile device, install and open the ActiveCaptain app.

TIP: You can scan this QR code using your mobile device to download the app.

- 7 Bring the mobile device within 32 m (105 ft.) of the ECHOMAP Ultra 2 device.
- 8 From your mobile device settings, open the Wi-Fi® connections page, and connect to the ECHOMAP Ultra 2 device, using the name and password you entered in step 3.



Updating Software with the ActiveCaptain® App

If your device has Wi-Fi® technology, you can use the ActiveCaptain app to download and install the latest software updates for your device.

NOTICE

Software updates may require the app to download large files. Regular data limits or charges from your Internet service provider apply. Contact your Internet service provider for more information about data limits or charges.

The installation process can take several minutes.

1 Connect the mobile device to the ECHOMAP™ Ultra 2 device (*Getting Started with the ActiveCaptain® App, page 26*).

2 When a software update is available and you have internet access on your mobile device, select **Software Updates > Download**.

The ActiveCaptain app downloads the update to the mobile device. When you reconnect the app to the ECHOMAP Ultra 2 device, the update is transferred to the device. After the transfer is complete, you are prompted to install the update.

3 When you are prompted by the ECHOMAP Ultra 2 device, select an option to install the update.

- To update the software immediately, select **OK**.
- To delay the update, select **Cancel**. When you are ready to install the update, select **ActiveCaptain > Software Updates > Install Now**.

For the best experience, you should keep the software on your device up to date. Software updates provide changes and improvements to privacy, security, and features.

Updating Charts with ActiveCaptain®

NOTE: Before you can update your charts, you must register them (*Getting Started with the ActiveCaptain® App, page 26*).

You can use the ActiveCaptain app to download and transfer the latest chart updates for your device. To shorten download time and conserve storage space, you can download only the areas of the chart you need.

After you download a chart or area for the first time, updates are automatic each time you open ActiveCaptain.

If you are downloading an entire chart, you can use the Garmin Express™ app to download the map onto a memory card (*Updating Your Charts Using the Garmin Express™ App, page 164*). The Garmin Express app downloads large charts more quickly than the ActiveCaptain app.

NOTICE

Chart updates may require the app to download large files. Regular data limits or charges from your internet service provider apply. Contact your internet service provider for more information about data limits or charges.

1 When you have internet access on your mobile device, select **Chart > ≡ > Download Charts**.

2 Select the area to download.

3 Select **Download**.

4 If necessary, select the map to update.

The ActiveCaptain app downloads the update to the mobile device. When you reconnect the app to the ECHOMAP™ Ultra 2 device, the update is transferred to that device. After the transfer is complete, the updated charts are available for use.

Chart Subscriptions

A chart subscription allows you to access the latest chart updates and additional content using the ActiveCaptain® mobile app. You can download updated charts and content each day.

You can purchase, activate, and renew chart subscriptions using the ActiveCaptain mobile app (*Detailed Charts, page 31*).

Wireless Sharing

You can connect an ECHOMAP™ Ultra 2 device to another ECHOMAP Ultra 2 device or to a ECHOMAP UHD2 device wirelessly to share user data and sonar ([Connecting Two Compatible ECHOMAP™ Devices to Share User Data and Sonar, page 28](#)). The first time you open the wireless network settings, you are prompted to set up the wireless network on the host device. After you set up the network, you can also connect the device to other wireless devices, such as your phone, to use the ActiveCaptain® app ([Getting Started with the ActiveCaptain® App, page 26](#)).

NOTE: If your connected compatible ECHOMAP devices are both on software version 41.00 or later, performing a software update on one device automatically updates the other connected device. You do not need to update each device separately.

Setting Up the Wi-Fi® Network

This device can host a Wi-Fi network to which you can connect wireless devices such as another chartplotter or your phone. The first time you access the wireless network settings, you are prompted to set up the network.

- 1 Select  > **Communications** > **Wi-Fi Network** > **Wi-Fi** > **On** > **OK**.
- 2 If necessary, enter a name for this wireless network.
- 3 Enter a password.

You will need this password to access the wireless network from a wireless device, such as your phone. The password is case-sensitive.



Connecting Two Compatible ECHOMAP™ Devices to Share User Data and Sonar

You can connect an ECHOMAP Ultra 2 device to another ECHOMAP Ultra 2 device or to a ECHOMAP UHD2 device to share user data and sonar wirelessly.

User data is shared automatically between the two devices while they are connected. Sonar sharing may require you to select a sonar source ([Sonar Sharing, page 28](#)).

To connect the two devices, you must designate one device as the host and the other device as the client. You can only connect two compatible ECHOMAP devices at a time. The host device can be connected to other wireless devices like your phone or tablet while it is connected with the client device.

NOTE: An ECHOMAP Ultra 2 device cannot connect to an ECHOMAP UHD2 5/7 cv set as the host device. You must set up the ECHOMAP Ultra 2 device as the host in this situation.

- 1 Ensure the two compatible ECHOMAP devices are within range, 32 m (105 ft.), and turn on both devices.
- 2 On the compatible ECHOMAP device that will host the network, set up the Wi-Fi® network ([Setting Up the Wi-Fi® Network, page 28](#)).
- 3 On the compatible ECHOMAP host device, select  > **Communications** > **Wi-Fi Network** > **Wi-Fi** > **On** > **Host** > **Pair Chartplotter** > **Start**.
- 4 On the compatible ECHOMAP client device, select  > **Communications** > **Wi-Fi Network** > **Wi-Fi** > **On** > **Client** > **Pair Host** > **Start**.
- 5 Select **OK** after devices connect successfully.

To unpair the devices and remove the wireless credentials so they do not attempt to connect in the future, on the client device select  > **Communications** > **Wi-Fi Network** > **Unpair**.

If you cannot connect the two devices, troubleshoot the connection and try again ([Troubleshooting the Wireless Connection, page 28](#)).

Sonar Sharing

Two compatible ECHOMAP™ devices connected over the Wi-Fi® network can share sonar ([Connecting Two Compatible ECHOMAP™ Devices to Share User Data and Sonar, page 28](#)).

If both of the ECHOMAP devices have a transducer connected, each device uses its own sonar source automatically. You can switch the sonar source manually to the other device ([Selecting a Sonar Source, page 77](#)).

If only one ECHOMAP device has a transducer connected, that device is the sonar source for both devices.

Troubleshooting the Wireless Connection

If you cannot connect two compatible ECHOMAP™ devices wirelessly, check the following items and try again.

- If you are connecting an ECHOMAP Ultra 2 device and a ECHOMAP UHD2 5/7 cv device, you must set up the ECHOMAP Ultra 2 as the network host. A ECHOMAP Ultra 2 device cannot connect to a ECHOMAP UHD2 5/7 cv device set up as the host.
- Ensure the two devices are within range (32 m (105 ft.)).

- Check for signal obstructions between the devices, especially metal.
- Turn the devices off and on again, and try to connect again.

Connecting a Wireless Device to the Chartplotter

Before you can connect a wireless device to the chartplotter wireless network, you must configure the chartplotter wireless network ([Setting Up the Wi-Fi® Network, page 28](#)).

You can connect multiple wireless devices to the chartplotter to share data.

- 1 From the wireless device, turn on the Wi-Fi® technology and search for wireless networks.
- 2 Select the name of your chartplotter wireless network ([Setting Up the Wi-Fi® Network, page 28](#)).
- 3 Enter the chartplotter password.

Managing the Wi-Fi® Network

Changing the Wi-Fi® Host

If there are multiple chartplotters with Wi-Fi technology on the Garmin® marine network, you can change which chartplotter is the Wi-Fi host. This can be helpful if you are having trouble with Wi-Fi communications. Changing the Wi-Fi host allows you to select a chartplotter that is physically closer to your mobile device.

- 1 Select  > **Communications** > **Wi-Fi Network** > **Advanced** > **Wi-Fi Host**.
- 2 Follow the on-screen instructions.

Changing the Wireless Channel

You can change the wireless channel if you have trouble finding or connecting to a device, or if you experience interference.

- 1 Select  > **Communications** > **Wi-Fi Network** > **Advanced** > **Channel**.
- 2 Enter a new channel.

You do not need to change the wireless channel of devices connected to this network.

Wireless Wind Sensor

Connecting a Wireless Sensor to the Chartplotter

You can view data from a compatible wireless sensor on the chartplotter.

- 1 Select  > **Communications** > **Wireless Devices**.
- 2 Select the wind sensor.
- 3 Select **Enable**.

The chartplotter begins searching for and connecting to the wireless sensor.

To view data from the sensor, add the data to a data field or gauge.

Adjusting the Wind Sensor Orientation



You should adjust this setting if the sensor does not face the front of the boat, exactly parallel to the center line. The opening where the cable connects to the pole indicates the front of the sensor.

- 1 Estimate the angle, in degrees clockwise around the mast, by which the sensor points away from the center of the front of the boat:
 - If the sensor is facing starboard, the angle should be between 1 and 180 degrees.
 - If the sensor is facing port, the angle should be between -1 and -180 degrees.
- 2 Select  > **Communications** > **Wireless Devices**.
- 3 Select the wind sensor.
- 4 Select **Wind Angle Offset**.
- 5 Enter the angle observed in step 1.
- 6 Select **Done**.

Viewing Boat Data on a Garmin® Watch

You can connect a compatible Garmin watch to a compatible chartplotter to view data from the chartplotter. For more information, see the owner's manual for your compatible Garmin watch.

TIP: In addition to viewing boat data, you can also use a compatible Garmin watch to control or view other features on the chartplotter:



- You can use the screen and buttons as a remote control to navigate the user interface (*Pairing a Garmin® Watch to Control a Garmin Chartplotter, page 30*).
 - You can control a compatible connected autopilot system (*Enabling the Autopilot Controls on a Garmin® Watch, page 93*).
- 1 Bring the Garmin watch within range (3 m) of the chartplotter.
 - 2 From the watch face, select  > **Boat Data** > .
- NOTE:** If you have already connected to a chartplotter, and would like to connect to a different chartplotter, open the Boat Data screen, hold UP, and select Pair New.
- 3 On the chartplotter, select  > **Communications** > **Wireless Devices** > **Wearables** > **Boat Data** > **Enable Connections** > **New Connection**.
- The chartplotter begins searching for and connecting to the watch.

After the devices are paired, they connect automatically when they are turned on and within range.

Pairing a Garmin® Watch to Control a Garmin Chartplotter

You can pair a compatible Garmin watch with your chartplotter and use the watch as a remote control to navigate the user interface. For more information, see the owner's manual for your compatible Garmin watch.

TIP: In addition to this remote-control feature, you can also use a compatible Garmin watch to control or view other features on the chartplotter:

- You can control a compatible connected autopilot system (*Enabling the Autopilot Controls on a Garmin® Watch, page 93*).
 - You can view important data about your boat, such as depth and speed (*Viewing Boat Data on a Garmin® Watch, page 29*).
- 1 On the chartplotter, select  > **Communications** > **Wireless Devices** > **Wireless Remotes** > **GPSMAP® Remote**.
 - 2 Select **New Connection**.
 - 3 On the compatible Garmin watch, , and select the **MFD Remote** app.
The watch should connect to the chartplotter, and the watch face shows remote control buttons that you can use to control the chartplotter.

Enabling Boat Mode on a Garmin® Watch

You must enable Boat Mode on your compatible Garmin watch before you can access some of the chartplotter-linked features, such as voice control.

- 1 On the watch, hold  to open the controls menu.
- 2 Select **Boat Mode**.

Charts and 3D Chart Views

The charts and 3D chart views that are available depend on the map data and accessories used.

NOTE: 3D chart views are available with premium charts, in some areas.

You can access the charts and 3D chart views by selecting Charts.

Nav. Chart: Shows navigation data available on your pre-loaded maps and from supplemental maps, if available. The data includes buoys, lights, cables, depth soundings, marinas, and tide stations in an overhead view.

Fishing Chart: Provides a detailed view of the bottom contours and depth soundings on the chart. This chart removes navigational data from the chart, provides detailed bathymetric data, and enhances bottom contours for depth recognition. This chart is best for offshore deep-sea fishing.

NOTE: The Fishing chart is available with premium charts, in some areas.

Perspective 3D: Provides a view from above and behind the boat (according to your course) and provides a visual navigation aid. This view is helpful when navigating tricky shoals, reefs, bridges, or channels, and is beneficial when trying to identify entry and exit routes in unfamiliar harbors or anchorages.

3D Chart: Shows a detailed, three-dimensional view from above and behind the boat (according to your course) and provides a visual navigation aid. This view is helpful when navigating tricky shoals, reefs, bridges, or channels, and when trying to identify entry and exit routes in unfamiliar harbors or anchorages.

Fish Eye 3D: Provides an underwater view that visually represents the sea floor according to the chart information. When a sonar transducer is connected, suspended targets (such as fish) are indicated by red, green, and yellow spheres. Red indicates the largest targets and green indicates the smallest.

Relief Shading: Provides high resolution elevation shading of lakes and coastal waters. This chart can be helpful for fishing and diving.

The Relief Shading chart is available with premium charts, in some areas.

Detailed Charts

This chartplotter is compatible with the latest Garmin Navionics+™ cartography and additional premium chart features. You can obtain these charts in three ways:

- You can purchase a chartplotter with preloaded detailed charts.
- You can purchase chart regions on a memory card from your Garmin® dealer or from garmin.com.
- You can purchase chart regions in the ActiveCaptain® app, and download them to your chartplotter.

NOTE: You must activate preloaded charts and charts purchased on a memory card using the ActiveCaptain app before you can access the full chart features on your chartplotter.

Activating a Marine Chart Subscription

Before you can use the full features of Garmin Navionics+™ charts that are preloaded on your device or purchased on a memory card, you must activate your subscription using the ActiveCaptain® app.

Your subscription allows you to access the latest chart updates and additional content included with your purchase.

- 1 If you purchased charts on a memory card, insert the card into a memory card slot on the chartplotter or Garmin® memory card reader.
- 2 Open the ActiveCaptain app on your mobile device, and connect it to the chartplotter (*Getting Started with the ActiveCaptain® App, page 26*).
- 3 After the ActiveCaptain app connects to the chartplotter, make sure your mobile device is connected to the internet.
- 4 In the ActiveCaptain app, select **Chart** >  > **My Charts**, and verify that an active subscription for the charts is shown in the list.
- 5 If necessary, connect the ActiveCaptain app to the chartplotter to complete the activation process. The ActiveCaptain app activates the subscription automatically after it connects to the internet and then to the chartplotter. The ActiveCaptain app shows the subscription status in the My Charts list.

NOTE: It might take a few hours to verify the new subscription.

Purchasing a Chart Subscription with ActiveCaptain®

- 1 Connect your mobile device to the internet and open the ActiveCaptain app.
- 2 Select **Chart** >  > **My Charts** > **Add a Chart Subscription**.
- 3 Select a chart.
- 4 Select **Subscribe Now**.

NOTE: It might take a few hours to display the new subscription.

Renewing Your Subscription

Your cartography subscription expires after one year. After the subscription expires, you can continue using the downloaded charts, but you are not able to download the latest chart updates or additional content.

- 1 Connect your mobile device to the internet and open the ActiveCaptain® app.
- 2 Select **Chart** >  > **My Charts**.
- 3 Select the chart to renew.
- 4 Select **Renew Now**.

NOTE: It might take a few hours to display the renewed subscription.

Navigation Chart and Fishing Chart

NOTE: The Fishing chart is available with premium charts, in some areas.



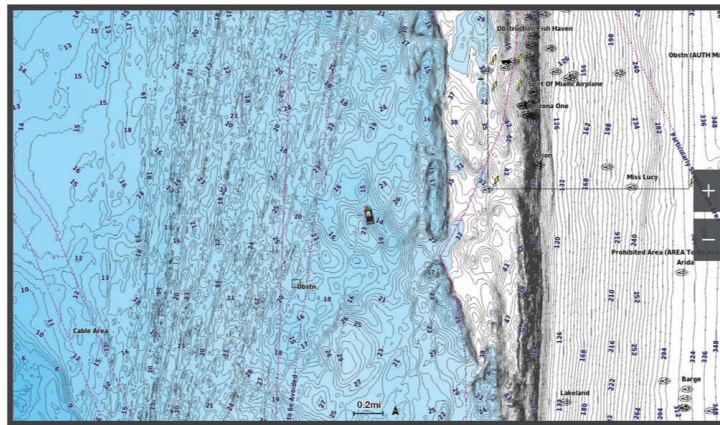



The Nav. Chart is optimized for navigation. You can plan a course, view map information, and use the chart as a navigational aid. To open the Nav. Chart, select **Charts > Nav. Chart**.



The Fishing Chart provides a detailed view with more bottom detail and fishing content. This chart is optimized for use when fishing. To open the Fishing Chart, select **Charts > Fishing Chart**.

Chart Symbols

This table contains some of the common symbols you might see on the detailed charts.

Icon	Description
	Buoy
	Information
	Marine services
	Tide station
	Current station
	Overhead photo available
	Perspective photo available

Other features common to most charts include depth contour lines, intertidal zones, spot soundings (as depicted on the original paper chart), navigational aids and symbols, obstructions, and cable areas.

Zooming In and Out Using the Touchscreen

You can quickly zoom in and out of many screens, such as the charts and sonar views.

- Pinch two fingers together to zoom out.
- Spread two fingers apart to zoom in.

Measuring a Distance on the Chart

- 1 From a chart, select a location.

2 Select **Measure**.

A push pin appears on the screen at your present location. The distance and angle from the pin is listed in the corner.

TIP: To reset the pin and measure from the current location of the cursor, select Set Reference.

Creating a Waypoint on the Chart

- 1 From a chart, select a location or object.
- 2 Select .

Viewing Location and Object Information on a Chart

You can view information, such as tide, current, celestial, chart notes, or local services, about a location or an object on the Navigation chart or the Fishing chart.

- 1 From the Navigation chart or Fishing chart, select a location or object.
A list of options appears. The options that appear vary based on the location or object you selected.
- 2 If necessary, select .
- 3 Select **Information**.

Viewing Details about Nav aids

From the Navigation chart, Fishing chart, Perspective 3D chart view, or Mariner's Eye 3D chart view, you can view details about various types of navigation aids, including beacons, lights, and obstructions.

NOTE: The Fishing chart is available with premium charts, in some areas.

NOTE: 3D chart views are available with premium charts, in some areas.

- 1 From a chart or 3D chart view, select a nav aid.
- 2 Select the name of the nav aid.

Navigating to a Point on the Chart

WARNING



All route and navigation lines displayed on the chartplotter are only intended to provide general route guidance or to identify proper channels, and are not intended to be precisely followed. Always defer to the nav aids and conditions on the water when navigating to avoid groundings or hazards that could result in vessel damage, personal injury, or death.

The Auto Guidance feature is based on electronic chart information. That data does not ensure obstacle and bottom clearance. Carefully compare the course to all visual sightings, and avoid any land, shallow water, or other obstacles that may be in your path.

When using Go To, a direct course and a corrected course may pass over land or shallow water. Use visual sightings, and steer to avoid land, shallow water, and other dangerous objects.

NOTE: The Fishing chart is available with premium charts, in some areas.

NOTE: Auto Guidance is available with premium charts, in some areas.

- 1 From the Navigation chart or Fishing chart, select a location.
- 2 If necessary, select **Navigate To**.
- 3 Select an option:
 - To navigate directly to the location, select **Go To** or .
 - To create a route to the location, including turns, select **Route To** or .
 - To use Auto Guidance, select **Auto Guidance** or .
- 4 Review the course indicated by the magenta line ([Route Color Coding, page 47](#)).
NOTE: When using Auto Guidance, a gray segment within any part of the magenta line indicates that Auto Guidance cannot calculate part of the Auto Guidance line. This is due to the settings for minimum safe water depth and minimum safe obstacle height.
- 5 Follow the magenta line, steering to avoid land, shallow water, and other obstacles.

Premium Chart Features

WARNING

All route and navigation lines displayed on the chartplotter are only intended to provide general route guidance or to identify proper channels, and are not intended to be precisely followed. Always defer to the nav aids and

conditions on the water when navigating to avoid groundings or hazards that could result in vessel damage, personal injury, or death.

The Auto Guidance feature is based on electronic chart information. That data does not ensure obstacle and bottom clearance. Carefully compare the course to all visual sightings, and avoid any land, shallow water, or other obstacles that may be in your path.

Not all models support all charts.

Optional premium charts, such as Garmin Navionics Vision+™, allow you to get the most out of your chartplotter. In addition to detailed marine charting, premium charts may contain these features, which are available in some areas.

NOTE: Not all premium chart features are available immediately after purchase. Before you can access all premium features you must activate your chart subscription and choose to download specific features using the ActiveCaptain® app ([Activating a Marine Chart Subscription, page 31](#)).

Mariner's Eye 3D: Provides a view from above and behind the boat for a three-dimensional navigation aid.

Fish Eye 3D: Provides an underwater, three-dimensional view that visually represents the sea floor according to the information on the chart.

Fishing Charts: Shows the chart with enhanced bottom contours and without navigational data. This chart works well for offshore deep-sea fishing.

High Resolution Satellite Imagery: Provides high-resolution satellite images for a realistic view of the land and water on the Navigation chart ([Showing Satellite Imagery on the Navigation Chart, page 35](#)).

Aerial Photos: Shows marinas and other navigationally significant aerial photos to help you visualize your surroundings ([Viewing Aerial Photos of Landmarks, page 35](#)).

Detailed Roads and POI data: Shows detailed road and point of interest (POI) data, which includes highly detailed coastal roads and POIs such as restaurants, lodging, and local attractions.

Auto Guidance: Uses specified information about your vessel and chart data to determine the best path to your destination.

Sonar Imagery: Shows sonar imagery to help show the density of the bottom.

Relief Shading: Shows the gradient of the bottom with shading.

Fish Eye 3D Chart View

Using the depth contour lines of the premium charts, such as Garmin Navionics Vision+™, the Fish Eye 3D chart view provides an underwater view of the sea floor or lake bottom.

Suspended targets, such as fish, are indicated by red, green, and yellow spheres. Red indicates the largest targets and green indicates the smallest.

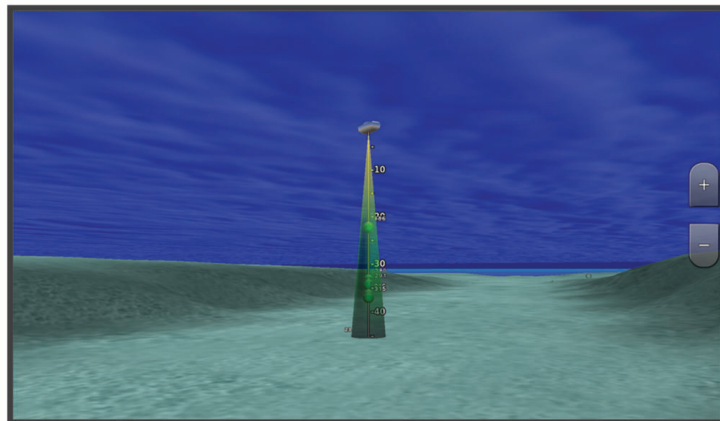

Viewing Tide Station Information

WARNING

Tide and current information is for information purposes only. It is your responsibility to heed all posted water-related guidance, to remain aware of your surroundings, and to use safe judgment in, on, and around the water at all times. Failure to heed this warning could result in property damage, serious personal injury, or death.

The  icon on the chart indicates a tide station. You can view a detailed graph for a tide station to help predict the tide level at different times or on different days.

NOTE: This feature is available with premium charts, in some areas.

1 From the Navigation chart or Fishing chart, select a tide station.

Tide direction and tide level information appear near .

2 Select the station name.

Animated Tide and Current Indicators

WARNING

Tide and current information is for information purposes only. It is your responsibility to heed all posted water-related guidance, to remain aware of your surroundings, and to use safe judgment in, on, and around the water at all times. Failure to heed this warning could result in property damage, serious personal injury, or death.

NOTE: This feature is available with premium charts, in some areas.

You can view indicators for animated tide station and current direction on the Navigation chart or the Fishing chart. You must also enable animated icons in the chart settings (*Showing Tides and Current Indicators*, page 35).

An indicator for a tide station appears on the chart as a vertical bar graph with an arrow. A red arrow pointing downward indicates a falling tide, and a blue arrow pointing upward indicates a rising tide. When you move the cursor over the tide station indicator, the height of the tide at the station appears above the station indicator.

Current direction indicators appear as arrows on the chart. The direction of each arrow indicates the direction of the current at a specific location on the chart. The color of the current arrow indicates the range of speed for the current at that location. When you move the cursor over the current direction indicator, the specific current speed at the location appears above the direction indicator.

Color	Current Speed Range
Yellow	0 to 1 knot
Orange	1 to 2 knots
Red	2 or more knots

Showing Tides and Current Indicators

NOTE: This feature is available with premium charts, in some areas.

You can show static or animated tide and current station indicators on the Navigation chart or Fishing chart.

1 From the Navigation or Fishing chart, select **••• > Layers > Chart > Tides & Currents**.

2 Select an option:

- To show animated tide station indicators and animated current direction indicators on the chart, select **Animated**.
- To enable the tides and current slider, which sets the time for which tides and currents are reported on the map, select **Slider**.

Showing Satellite Imagery on the Navigation Chart

NOTE: This feature is available with premium charts, in some areas.

You can overlay high-resolution satellite images on the land or on both land and sea portions of the Navigation chart.

NOTE: When enabled, high-resolution satellite images are present only at lower zoom levels. If you cannot see high-resolution images in your optional chart region, you can select **+** to zoom in. You also can set the detail level higher by changing the map zoom detail.

1 From the Navigation chart, select **••• > Layers > Chart > Satellite Photos**.

2 Select an option:

- Select **Land Only** to show standard chart information on the water, with photos overlaying the land. This setting must be enabled to view Standard Mapping® charts.
- Select **Photo Map** to show photos on both the water and the land at a specified opacity. Use the slider bar to adjust the photo opacity. The higher you set the percentage, the more the satellite photos cover both land and water.



Viewing Aerial Photos of Landmarks

Before you can view aerial photos on the Navigation chart, you must turn on the Photo Points setting in the chart setup (*Chart Layers*, page 40).

NOTE: This feature is available with premium charts, in some areas.

You can use aerial photographs of landmarks, marinas, and harbors to help orient yourself to your surroundings or to acquaint yourself with a marina or a harbor prior to arrival.

1 From the Navigation chart, select a camera icon:

- To view an overhead photo, select .
- To view a perspective photo, select . The photo was taken from the location of the camera, pointed in the direction of the cone.

2 Select **Photo**.

Automatic Identification System

WARNING

AIS and other broadcast messages are intended for situational awareness only and may not prevent collisions in all circumstances. You are responsible for the safe and prudent operation of your vessel, for remaining aware of your surroundings, and for using safe judgment on the water at all times.

The Automatic Identification System (AIS) enables you to identify and track other vessels, and alerts you to area traffic. When connected to an external AIS device, the chartplotter can show some AIS information about other vessels that are within range, that are equipped with a transponder, and that are actively transmitting AIS information.

The information reported for each vessel includes the Maritime Mobile Service Identity (MMSI), location, GPS speed, GPS heading, time that has elapsed since the last position of the vessel was reported, nearest approach, and time to the nearest approach.







Some chartplotter models also support Blue Force Tracking. Vessels being tracked with Blue Force Tracking are indicated on the chartplotter with a blue-green color.

In addition to receiving AIS information from vessels, you can also receive important broadcast messages, such as those sent for protection of marine mammals.

CAUTION

AIS broadcast messages are generated by third parties, and Garmin cannot guarantee the availability of these messages in all regions. Additionally, Garmin makes no representations about the accuracy, completeness, or timeliness of information provided by AIS broadcast messages. You must remain aware of your surroundings at all times, and any use or reliance on the information provided by AIS broadcast messages is at your own risk.

AIS Targeting Symbols

Symbol	Description
	AIS vessel. The vessel is reporting AIS information. The direction in which the triangle is pointing indicates the direction in which the AIS vessel is moving.
	Target is selected.
	Target is activated. The target appears larger on the chart. A green line attached to the target indicates the heading of the target. The MMSI, speed, and direction of the vessel appear beneath the target, if the details setting has been set to Show. If the AIS transmission from the vessel is lost, a message banner appears.
	Target is lost. A green X indicates that the AIS transmission from the vessel is lost, and the chartplotter displays a message banner asking whether the vessel should continue to be tracked. If you discontinue vessel tracking, the lost target symbol disappears from the chart or the 3D chart view.
	Dangerous target in range. The target flashes while an alarm sounds and a message banner appears. After the alarm has been acknowledged, a solid red triangle with a red line attached to it indicates the location and the heading of the target. If the safe-zone collision alarm has been set to Off, the target flashes, but the audible alarm does not sound and the alarm banner does not appear. If the AIS transmission from the vessel is lost, a message banner appears.
	Dangerous target is lost. A red X indicates that the AIS transmission from the vessel is lost, and the chartplotter displays a message banner asking whether the vessel should continue to be tracked. If you discontinue vessel tracking, the lost dangerous target symbol disappears from the chart or the 3D chart view.
	The location of this symbol indicates the closest point of approach to a dangerous target, and the numbers near the symbol indicate the time to the closest point of approach to that target.

NOTE: Vessels being tracked with the Blue Force Tracking feature are indicated with a blue-green color regardless of their status.

Heading and Projected Course of Activated AIS Targets

When heading and course over ground information are provided by an activated AIS target, the heading of the target appears on a chart as a solid line attached to the AIS target symbol. A heading line does not appear on a 3D chart view.

The projected course of an activated AIS target appears as a dashed line on a chart or a 3D chart view. The length of the projected course line is based on the value of the projected heading setting. If an activated AIS target is not transmitting speed information, or if the vessel is not moving, a projected course line does not appear. Changes in the speed, course over ground, or rate of turn information transmitted by the vessel can impact the calculation of the projected course line.

When course over ground, heading, and rate of turn information are provided by an activated AIS target, the projected course of the target is calculated based on the course over ground and the rate of turn information. The direction in which the target is turning, which is also based on the rate of turn information, is indicated by the direction of the barb at the end of the heading line. The length of the barb does not change.



When course over ground and heading information are provided by an activated AIS target, but rate of turn information is not provided, the projected course of the target is calculated based on the course over ground information.

Viewing a List of AIS Threats

- 1 From a chart or 3D chart view, select **⋮** > **Layers** > **Other Vessels** > **AIS** > **AIS List**.

TIP: You can quickly access the AIS list from the messages and warnings menu (*Messages and Warnings*, page 135).

- 2 If necessary, select **Display Options** to sort or filter the items in the list.

Activating a Target for an AIS Vessel

- 1 From a chart or 3D chart view, select **⋮** > **Layers** > **Other Vessels** > **AIS** > **AIS List**.

TIP: You can quickly access the AIS list from the messages and warnings menu (*Messages and Warnings*, page 135).

- 2 Select a vessel from the list.
- 3 Select **Review** and review the target information.
- 4 Select **Activate Target**.

Viewing Information about a Targeted AIS Vessel

You can view the AIS signal status, MMSI, GPS speed, GPS heading, and other information that is reported about a targeted AIS vessel.

- 1 From a chart or a 3D chart view, select an AIS vessel.
- 2 Select **AIS Vessel**.

Deactivating a Target for an AIS Vessel

- 1 From a chart or a 3D chart view, select an AIS vessel.
- 2 Select **AIS Vessel** > **Deactivate**.

Showing AIS Vessels on a Chart or 3D Chart View

Before you can use AIS, you must connect the chartplotter to an external AIS device and receive active transponder signals from other vessels.

You can configure how other vessels appear on a chart or on a 3D chart view. The display range configured for one chart or one 3D chart view are applied only to that chart or to that 3D chart view. The details, projected heading, and trails settings configured for one chart or one 3D chart view are applied to all charts and to all 3D chart views.

- 1 From a chart or 3D chart view, select **⋮** > **Layers** > **Other Vessels** > **AIS**.
- 2 Select an option:
 - To show the tracks of AIS vessels, select **AIS Trails** and adjust the trail length if needed. .

- To indicate the distance from your location in which AIS vessels appear, select **Display Range**, and select a distance.
- To show a list of AIS-activated vessels, select **AIS List**.

Setting the Safe-Zone Collision Alarm

⚠ WARNING

The safe-zone collision alarm is a tool for situational awareness only and may not prevent collisions in all circumstances. You are responsible for the safe and prudent operation of your vessel, for remaining aware of your surroundings, and for using safe judgment on the water at all times.

⚠ CAUTION

The Beeper setting must be turned on to make alarms audible (*Sounds and Display Settings*, page 152). Failure to set audible alarms could lead to injury or property damage.

Before you can set a collision alarm, you must connect an AIS device to the same network as a compatible chartplotter.

The safe-zone collision alarm is used for AIS vessels. The safe zone is used for collision avoidance and can be customized.

1 Select > **Alarms** > **Collision Alarm** > **On**.

A message banner appears and an alarm sounds when an AIS-activated vessel enters the safe-zone area around your boat. The vessel is also labeled as dangerous on the screen. When the alarm is off, the message banner and audible alarm are disabled, but the vessel is still labeled as dangerous on the screen.

2 Select **Range**, and select a distance for the safe-zone radius around your vessel.

3 Select **Time To**, and select a time at which the alarm will sound if a target is determined to intersect the safe zone.















For example, to be notified of a pending intersection 10 minutes before it will likely occur, set Time To to 10, and the alarm will sound 10 minutes before the vessel intersects the safe zone.

AIS Aids to Navigation

An AIS aid to navigation (ATON) is any kind of navigational aid that is transmitted over the AIS radio. ATONs are displayed on the charts and have identifying information, such as position and type.

There are three main kinds of AIS ATONs. Real ATONs physically exist and send their identifying and location information from their actual location. Synthetic ATONs physically exist, and their identifying and location information is sent from another location. Virtual ATONs do not actually exist, and their identifying and location information is sent from another location.

You can view AIS ATONs on the chart when the chartplotter is connected to a compatible AIS radio. To show AIS ATONs, from a chart, select **•••** > **Layers** > **Chart** > **Navaid** > **ATONs**. You can view more information about an ATON if you select the ATON on the chart.

Symbol	Meaning
	Real or synthetic ATON
	Real or synthetic ATON: Topmark North
	Real or synthetic ATON: Topmark South
	Real or synthetic ATON: Topmark East
	Real or synthetic ATON: Topmark West
	Real or synthetic ATON: Topmark Special
	Real or synthetic ATON: Topmark Safe
	Real or synthetic ATON: Topmark Danger
	Virtual ATON
	Virtual ATON: Topmark North
	Virtual ATON: Topmark South
	Virtual ATON: Topmark East
	Virtual ATON: Topmark West
	Virtual ATON: Topmark Special

Symbol	Meaning
	Virtual ATON: Topmark Safe
	Virtual ATON: Topmark Danger

AIS Distress Signals





Self-contained AIS distress signal devices transmit emergency position reports when activated. The chartplotter can receive signals from Search and Rescue Transmitters (SART), Emergency Position Indicating Radio Beacons (EPIRB), and other man overboard signals. Distress signal transmissions are different than standard AIS transmissions, so they appear differently on the chartplotter. Instead of tracking a distress signal transmission for collision avoidance, you track a distress signal transmission to locate and assist a vessel or person.

Navigating to a Distress Signal Transmission

When you receive a distress signal transmission, a distress signal alarm appears.

Select **Review > Go To** to begin navigation to the transmission.

AIS Distress Signal Device Targeting Symbols

Symbol	Description
	AIS distress signal device transmission. Select to see more information about the transmission and begin navigation.
	Transmission lost.
	Transmission test. Appears when a vessel initiates a test of their distress signal device, and does not represent a true emergency.
	Transmission test lost.

Enabling AIS Transmission Test Alerts

To avoid a large number of test alerts and symbols in crowded areas such as marinas, you can select to receive or ignore AIS test messages. To test an AIS emergency device, you must enable the chartplotter to receive test alerts.

- 1 Select  > **Alarms > AIS**.
- 2 Select an option:
 - To receive or ignore Emergency Position Indicating Radio Beacon (EPRIB) test signals, select **AIS-EPIRB Test**.
 - To receive or ignore Man Overboard (MOB) test signals, select **AIS-MOB Test**.
 - To receive or ignore Search and Rescue Transponder (SART) test signals, select **AIS-SART Test**.

Turning Off AIS Reception

AIS signal reception is turned on by default.

Select  > **Other Vessels > AIS > Off**.

All AIS functionality on all charts and 3D chart views is disabled. This includes AIS vessel targeting and tracking, collision alarms that result from AIS vessel targeting and tracking, and the display of information about AIS vessels.

Turning Off AIS Broadcast Warning Messages

The reception of AIS Broadcast Warning Messages is turned on by default. This includes messages intended for the protection of marine mammals.

CAUTION

AIS broadcast messages must be turned on for you to receive them. If this feature is turned off, you will not receive these messages, including those intended for the protection of marine mammals. Failure to have these messages on could lead to injury or property damage.

Select  > **Other Vessels > AIS Broadcast Safety Messages**.

You will no longer receive AIS broadcast messages. You will continue to receive AIS addressed messages, because those message designations cannot be disabled.

Chart Menu

Not all settings apply to all charts. Some options require premium maps or connected accessories, such as radar.

The menus may contain some settings that are not supported by your installed charts or your present location. If you make changes to those settings, the changes will not impact the chart view.

From a chart, select •••.

Layers: Adjusts the appearance of the different items on the charts ([Chart Layers, page 40](#)).

Quickdraw Contours: Turns on bottom contour drawing, and allows you to create fishing map labels ([Garmin Quickdraw™ Contours Mapping, page 44](#)).

Settings: Adjusts the chart settings ([Chart Settings, page 42](#)).

Edit Overlays: Adjusts the data shown on the screen ([Customizing the Data Overlays, page 18](#)).

Chart Layers

You can turn on and off chart layers and customize features of the charts. Each setting is specific to the chart or chart view being used.

Not all settings apply to all charts and chartplotter models. Some options require premium maps or connected accessories.

The menus may contain some settings that are not supported by your installed charts or your present location. If you make changes to those settings, the changes will not impact the chart view.

From a chart, select ••• > **Layers**.

Chart: Shows and hides chart-related items ([Chart Layer Settings, page 40](#)).

My Vessel: Shows and hides items relating to the boat ([My Vessel Layer Settings, page 40](#)).

Manage User Data: Shows and hides user data, such as waypoints, boundaries, and tracks, and opens user data lists ([User Data Layer Settings, page 41](#)).

Other Vessels: Adjusts how other vessels are shown ([Other Vessels Layer Settings, page 41](#)).

Water: Shows and hides depth items ([Water Layer Settings, page 42](#)).

Quickdraw Contours: Shows and hides Garmin Quickdraw™ Contours data ([Garmin Quickdraw™ Contours Settings, page 45](#)).

Chart Layer Settings

From a chart, select ••• > **Layers** > **Chart**.

Satellite Photos: Shows high-resolution satellite images on the land or on both land and sea portions of the Navigation chart, when certain premium maps are used ([Showing Satellite Imagery on the Navigation Chart, page 35](#)).

This setting must be enabled to view Standard Mapping® charts.

Tides & Currents: Shows current station indicators and tide station indicators on the chart ([Showing Tides and Current Indicators, page 35](#)) and enables the tides and current slider, which sets the time for which tides and currents are reported on the map.

Land POIs: Shows points of interest on land.

Navaid: Shows navigational aids, such as ATONs and flashing lights, on the chart. Allows you to select NOAA or IALA navaid type.

Service Points: Shows locations for marine services.

Depth: Adjusts the items on the depth layer ([Depth Layer Settings, page 40](#)).

Restricted Areas: Shows information about restricted areas on the chart.

Photo Points: Shows camera icons for aerial photos ([Viewing Aerial Photos of Landmarks, page 35](#)).

Depth Layer Settings

From a chart, select ••• > **Layers** > **Chart** > **Depth**.

Depth Shading: Specifies an upper and lower depth to shade between.

Shallow Shading: Sets the shades from the shoreline to the specified depth.

Spot Depths: Turns on spot soundings and sets a dangerous depth. Spot depths that are equal to or more shallow than the dangerous depth are indicated by red text.

Fishing Contours: Sets the zoom level for a detailed view of bottom contours and depth soundings and simplifies map presentation for optimal use while fishing.

My Vessel Layer Settings

From a chart, select ••• > **Layers** > **My Vessel**.

Heading Line: Shows and adjusts the heading line, which is a line drawn on the map from the bow of the boat in the direction of travel ([Setting the Heading Line and Angle Markers, page 66](#)).

Heading Line > Stern Line: Shows an extension from the stern of the boat in the opposite direction of travel.

Active Tracks: Shows the active track on the chart and opens the Active Track Options menu.

Wind Rose: Shows a visual representation of the wind angle or direction provided by the connected wind sensor and sets the wind source.

Compass Rose: Shows a compass rose around your boat, indicating compass direction oriented to the heading of the boat. Enabling this option disables the Wind Rose option.

Vessel Icon: Sets the icon that represents your present location on the chart.

Laylines Settings

To use the laylines features, you must connect a wind sensor to the chartplotter.

When in sailing mode ([Setting the Vessel Type for Sailing Features, page 58](#)), you can display laylines on the navigation chart. Laylines can be very helpful when racing.

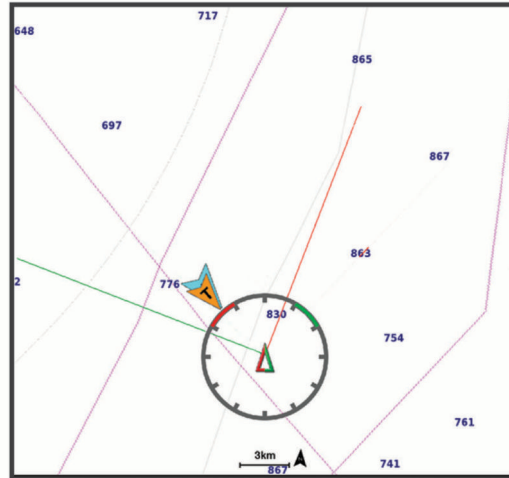

From the Navigation chart, select **••• > Layers > My Vessel > Laylines > Setup**.

Sailing Ang.: Allows you to select how the device calculates laylines. The Actual option calculates the laylines using the measured wind angle from the wind sensor. The Manual option calculates the laylines using manually entered windward and leeward angles. The Polar Table option calculates the laylines based on the imported polar table data ([Importing a Polar Table Manually, page 61](#)).

Windward Ang.: Allows you to set a layline based on the windward sailing angle.

Leeward Ang.: Allows you to set a layline based on the leeward sailing angle.

Layline Filter: Filters the layline data based on the time interval entered. For a smoother layline that filters out some of the changes in the boat's heading or true wind angle, enter a higher number. For laylines that display a higher sensitivity to changes in the boat's heading or true wind angle, enter a lower number.

User Data Layer Settings

You can show user data, such as waypoints, boundaries, and tracks, on the charts.

From a chart, select **••• > Layers > Manage User Data**.

Waypoints: Shows waypoints on the chart and opens the list of waypoints.

Boundaries: Shows boundaries on the chart and opens the list of boundaries.

Tracks: Shows tracks on the chart.

Other Vessels Layer Settings

These options require connected accessories, such as an AIS receiver or VHF radio.

From a chart, select **••• > Layers > Other Vessels**.

DSC: Sets how DSC vessels and trails appear on the chart, and shows the DSC list.

AIS: Sets how AIS vessels and trails appear on the chart, and shows the AIS list.

Details: Shows other vessel details on the chart.

Proj. Heading: Sets the projected heading time for AIS-activated vessels.

Collision Alarm: Sets the safe-zone collision alarm ([Setting the Safe-Zone Collision Alarm, page 38](#)).

Water Layer Settings

From a chart, select **☰ > Layers > Water**.

The menu may contain some settings that are not supported by your installed charts or your present location. If you make changes to those settings, the changes will not impact the chart view.

NOTE: Not all settings apply to all charts, views, and chartplotter models. Some options require premium maps or connected accessories.

Depth Shading: Specifies an upper and lower depth to shade between ([Depth Range Shading, page 42](#)).

Shallow Shading: Sets the shades from the shoreline to the specified depth.

Spot Depths: Turns on spot soundings and sets a dangerous depth. Spot depths that are equal to or more shallow than the dangerous depth are indicated by red text.

Fishing Contours: Sets the zoom level for a detailed view of bottom contours and depth soundings and simplifies map presentation for optimal use while fishing.

Relief Shading: Shows the gradient of the bottom with shading. This feature is available only with some premium maps.

Sonar Imagery: Shows sonar imagery to help show the density of the bottom. This feature is available only with some premium maps.

Lake Level: Sets the present water level of the lake. This feature is available only with some premium maps.

Depth Range Shading

You can set color ranges on your map to show the water depths where your target fish are currently biting. You can set deeper ranges to monitor how quickly the bottom depth changes within a specific depth range. You can create up to ten depth ranges. For inland fishing, a maximum of five depth ranges can help reduce map clutter. The depth ranges apply to all charts and all bodies of water.

Some Garmin LakeVü™ and premium supplemental charts have multiple depth range shading by default.

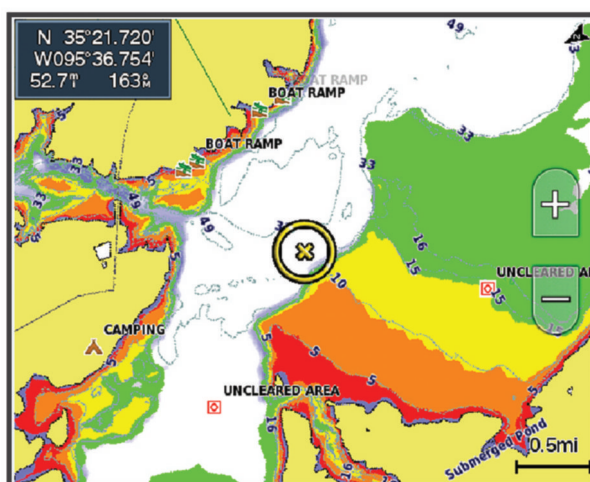

Red	From 0 to 1.5 m (from 0 to 5 ft.)
Orange	From 1.5 to 3 m (from 5 to 10 ft.)
Yellow	From 3 to 4.5 m (from 10 to 15 ft.)
Green	From 4.5 to 6.1 m (from 15 to 20 ft.)

To turn on and adjust, from a chart, select **☰ > Layers > Water > Depth Shading**.

Chart Settings

Not all settings apply to all charts and 3D chart views. Some settings require external accessories or applicable premium charts.

From a chart, select **☰ > Chart Settings**.

Map Orientation: Sets the perspective of the map.

Look Ahead: Shifts your present location toward the bottom of the screen automatically as your speed increases. Enter your top speed for the best results.

Vessel Orientation: Sets the alignment of the vessel icon on the map. The Auto option aligns the vessel icon using GPS COG at high speeds and the magnetic heading at low speeds to better align the vessel icon with

the active track line. The Heading option aligns the vessel icon with the magnetic heading. The GPS Heading (COG) option aligns the vessel icon using GPS COG. If the selected data source is not available, the available data source is used instead.

WARNING

The vessel orientation setting is for informational purposes and is not intended to be precisely followed. Always defer to the nav aids and conditions on the water to avoid groundings or hazards that could result in vessel damage, personal injury, or death.

You can set the Map Orientation and Vessel Orientation settings separately for two navigation charts used in a combination page.

Detail: Adjusts the amount of detail shown on the map, at different zoom levels.

Chart Size: Sets the visible size of the chart.

World Map: Uses either a basic world map or a shaded relief map on the chart. These differences are visible only when zoomed out too far to see the detailed charts.

Start Line: Sets the starting line for the sailing race ([Setting the Starting Line, page 59](#)).

Inset Map: Shows a small map centered on your present location.

Fish Eye 3D Settings

NOTE: This feature is available with premium charts, in some areas.

From the Fish Eye 3D chart view, select **•••**.

View: Sets the perspective of the 3D chart view.

Tracks: Shows tracks.

Sonar Cone: Shows a cone that indicates the area covered by the transducer.

Fish Symbols: Shows suspended targets.

Supported Maps

To help you have a safe and enjoyable time on the water, Garmin® devices only support official maps produced by Garmin or an approved third party producer.

You can purchase maps from Garmin. If you purchase maps from a seller other than Garmin, investigate the seller before purchasing. Be extra cautious with online sellers. If you have purchased an unsupported map, return it to the seller.

Garmin Quickdraw™ Contours Mapping

⚠ WARNING

The Garmin Quickdraw Contours mapping feature allows users to generate maps. Garmin® makes no representations about the accuracy, reliability, completeness or timeliness of the maps generated by third parties. Any use or reliance on the maps generated by third parties is at your own risk.

The Garmin Quickdraw Contours mapping feature allows you to instantly create maps with contours and depth labels for any body of water.

When Garmin Quickdraw Contours records data, a colored circle surrounds the vessel icon. This circle represents the approximate area of the map that is scanned by each pass.

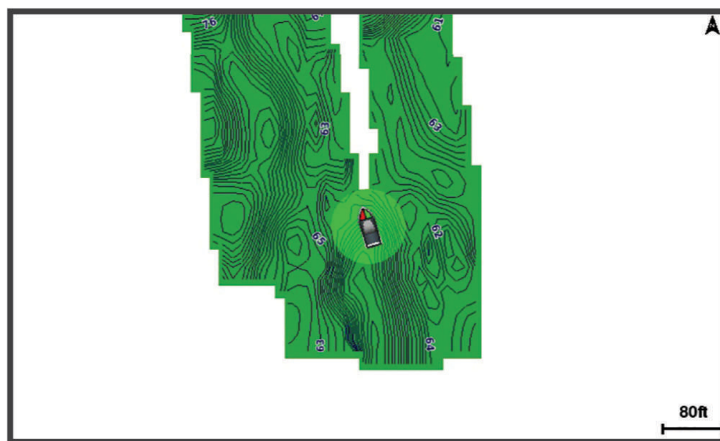

A green circle indicates good depth and GPS position, and a speed under 16 km/h (10 mph). A yellow circle indicates good depth and GPS position, and a speed between 16 and 32 km/h (10 and 20 mph). A red circle indicates poor depth or GPS position, and a speed above 32 km/h (20 mph).

You can view Garmin Quickdraw Contours in a combination screen or as a single view on the map.

The amount of saved data depends on the size of your memory card, your sonar source, and the speed of your boat as you record data. You can record longer when you use a single-beam sonar. It is estimated that you might be able to record about 1,500 hours of data onto a 2 GB memory card.

When you record data on a memory card in your chartplotter, the new data is added to your existing Garmin Quickdraw Contours map, and is saved on the memory card. When you insert a new memory card, the existing data does not transfer onto the new card.

Mapping a Body of Water Using the Garmin Quickdraw™ Contours Feature

Before you can use the Garmin Quickdraw Contours feature, you must have sonar depth, your GPS position, and a memory card with free space.

- 1 From a chart view, select **••• > Quickdraw Contours > Start Recording**.
- 2 When recording is complete, select **••• > Quickdraw Contours > Stop Recording**.
- 3 Select **Manage > Name**, and enter a name for the map.

Adding a Label to a Garmin Quickdraw™ Contours Map

You can add labels to a Garmin Quickdraw Contours map to mark hazards or points of interest.

- 1 From the Navigation chart, select a location.
- 2 Select **Quickdraw Lbl.**
- 3 Enter text for the label, and select **Done**.

Garmin Quickdraw™ Community

The Garmin Quickdraw Community is a free, public, online community that enables you to download maps other users have created. You can share your Garmin Quickdraw Contours maps with others. You must use the ActiveCaptain® app to access the Garmin Quickdraw Community ([Connecting to the Garmin Quickdraw™ Community with ActiveCaptain®](#), page 45).

NOTE: The Garmin® device must have a memory card slot and Wi-Fi® technology to participate in the Garmin Quickdraw Community.

Connecting to the Garmin Quickdraw™ Community with ActiveCaptain®

- 1 From your mobile device, open the ActiveCaptain app and connect to the ECHOMAP™ Ultra 2 device (*Getting Started with the ActiveCaptain® App*, page 26).
- 2 From the app, select **Quickdraw Community**.

You can download contours from others in the community (*Downloading Garmin Quickdraw™ Community Maps Using ActiveCaptain®*, page 45) and share the contours you have created (*Sharing Your Garmin Quickdraw™ Contours Maps with the Garmin Quickdraw Community Using ActiveCaptain®*, page 45).

Downloading Garmin Quickdraw™ Community Maps Using ActiveCaptain®

You can download Garmin Quickdraw Contours maps that other users have created and shared with the Garmin Quickdraw Community.

- 1 From the ActiveCaptain app on your mobile device, select **Quickdraw Community > Search for Contours**.
- 2 Use the map and search features to locate an area to download.
The red dots represent Garmin Quickdraw Contours maps that have been shared for that area.
- 3 Select **Select Download Region**.
- 4 Drag the box to select the area to download.
- 5 Drag the corners to change the download area.
- 6 Select **Download Area**.

The next time you connect the ActiveCaptain app to the ECHOMAP™ Ultra 2 device, the downloaded contours are transferred to the device automatically.

Sharing Your Garmin Quickdraw™ Contours Maps with the Garmin Quickdraw Community Using ActiveCaptain®

You can share Garmin Quickdraw Contours maps that you have created with others in the Garmin Quickdraw Community.

When you share a contour map, only the contour map is shared. Your waypoints are not shared.

When you set up your ActiveCaptain app, you may have selected to share your contours with the community automatically. If not, follow these steps to enable sharing.

From the ActiveCaptain app on your mobile device, select **Sync with Plotter > Contribute to Community**.

The next time you connect the ActiveCaptain app to the ECHOMAP™ Ultra 2 device, your contour maps are transferred to the community automatically.

Garmin Quickdraw™ Contours Settings

From a chart, select **••• > Quickdraw Contours > Settings**.

Recording Offset: Sets the distance between the sonar depth and the contour recording depth. If the water level has changed since your last recording, adjust this setting so the recording depth is the same for both recordings.

For example, if the last time you recorded had a sonar depth of 3.1 m (10.5 ft.), and today's sonar depth is 3.6 m (12 ft.), enter -0.5 m (-1.5 ft.) for the a Recording Offset value.

User Display Offset: Sets differences in contour depths and depth labels on your own contours maps to compensate for changes in the water level of a body of water, or for depth errors in recorded maps.

Comm. Display Offset: Sets differences in contour depths and depth labels on the community contours maps to compensate for changes in the water level of a body of water, or for depth errors in recorded maps.

Survey Coloring: Sets the color of the Garmin Quickdraw Contours display. When this setting is turned on, the colors indicate the quality of the recording. When this setting is turned off, the contour areas use standard map colors.

Green indicates good depth and GPS position, and a speed under 16 km/h (10 mph). Yellow indicates good depth and GPS position, and a speed between 16 and 32 km/h (10 and 20 mph). Red indicates poor depth or GPS position, and a speed above 32 km/h (20 mph).

Depth Shading: Specifies the minimum and maximum depths of a depth range and a color for that depth range.

Navigation with a Chartplotter

⚠ WARNING

All route and navigation lines displayed on the chartplotter are only intended to provide general route guidance or to identify proper channels, and are not intended to be precisely followed. Always defer to the navaids and conditions on the water when navigating to avoid groundings or hazards that could result in vessel damage, personal injury, or death.

The Auto Guidance feature is based on electronic chart information. That data does not ensure obstacle and bottom clearance. Carefully compare the course to all visual sightings, and avoid any land, shallow water, or other obstacles that may be in your path.

When using Go To, a direct course and a corrected course may pass over land or shallow water. Use visual sightings, and steer to avoid land, shallow water, and other dangerous objects.

⚠ CAUTION

If your vessel has an autopilot system, a dedicated autopilot control display must be installed at each steering helm in order to disable the autopilot system.

Some chart views are available with premium charts, in some areas.

To navigate, you must choose a destination, set a course or create a route, and follow the course or route. You can follow the course or the route on the Navigation chart, Fishing chart, Perspective 3D chart view, or Mariner's Eye 3D chart view.

You can set and follow a course to a destination using one of three methods: Go To, Route To, or Auto Guidance.

Go To: Takes you directly to the destination. This is the standard option for navigating to a destination. The chartplotter creates a straight-line course or navigation line to the destination. The path may run over land and other obstacles.

Route To: Creates a route from your location to a destination, allowing you to add turns along the way. This option provides a straight-line course to the destination, but allows you to add turns into the route to avoid land and other obstacles.

Auto Guidance: Uses the specified information about your vessel and chart data to determine the best path to your destination. This option is available only when using a compatible premium chart in a compatible chartplotter. It provides a turn-by-turn navigation path to the destination, avoiding land and other obstacles ([Auto Guidance, page 52](#)).

When you are using a compatible autopilot connected to the chartplotter using NMEA 2000®, the autopilot follows the Auto Guidance route.

NOTE: Auto Guidance is available with premium charts, in some areas.

The color of the route line changes depending upon several factors ([Route Color Coding, page 47](#)).

Basic Navigation Questions

Question	Answer
How do I make the chartplotter point me in the direction in which I want to go (bearing)?	Navigate using Go To (Setting and Following a Direct Course Using Go To, page 47).
How do I make the device guide me along a straight line (minimizing cross track) to a location using the shortest distance from the present location?	Build a single-leg route and navigate it using Route To (Creating and Navigating a Route From Your Present Location, page 50).
How do I make the device guide me to a location while avoiding charted obstacles?	Build a multi-leg route and navigate it using Route To (Creating and Navigating a Route From Your Present Location, page 50).
How do I make the device steer my automatic pilot?	Navigate using Route To (Creating and Navigating a Route From Your Present Location, page 50).
Can the device create a path for me?	If you have premium maps that support Auto Guidance and are in an area covered by Auto Guidance, navigate using Auto Guidance (Setting and Following an Auto Guidance Path, page 52).
How do I change the Auto Guidance settings for my boat?	See Auto Guidance Path Configurations, page 53 .

Route Color Coding

WARNING

All route and navigation lines displayed on the chartplotter are only intended to provide general route guidance or to identify proper channels, and are not intended to be precisely followed. Always defer to the nav aids and conditions on the water when navigating to avoid groundings or hazards that could result in vessel damage, personal injury, or death.

The Auto Guidance feature is based on electronic chart information. That data does not ensure obstacle and bottom clearance. Carefully compare the course to all visual sightings, and avoid any land, shallow water, or other obstacles that may be in your path.

When using Go To, a direct course and a corrected course may pass over land or shallow water. Use visual sightings, and steer to avoid land, shallow water, and other dangerous objects.

As you navigate, the color of the route might change to indicate when you should take caution.

Magenta: Default route/course line.

Thin purple: Dynamically corrected course, indicating you are off course.

Orange: Caution! This segment of the route may be near the thresholds of the Auto Guidance depth and height settings. For example, the route segment is orange when the route crosses under a bridge or is in potentially shallow waters. Garmin Navionics+™ and Garmin Navionics Vision+™ charts only.

Red striped: Warning! This segment of the route might be unsafe, based on the Auto Guidance depth and height settings. For example, the route segment is red striped when the route crosses under a very low bridge or is in shallow waters. This line is red striped in Garmin Navionics+ and Garmin Navionics Vision+ charts only; it is magenta and gray striped in previous versions of the charts.

Gray: Cannot calculate this segment of the route due to land or other obstacles, or there is no chart coverage area in that location.

Destinations

You can select destinations using various charts and 3D chart views or using the lists.

Searching for a Destination by Name

You can search for saved waypoints, saved routes, saved tracks, and marine services destinations by name.

- 1 Select **Where To > Services > Search by Name**.
- 2 Enter at least a portion of the name of your destination.
- 3 If necessary, select **Done**.
The 50 nearest destinations that contain your search criteria appear.
- 4 Select the destination.

Selecting a Destination Using the Navigation Chart

From the Navigation chart, select a destination.

Searching for a Marine Services Destination

NOTE: This feature is available with premium charts, in some areas.

The chartplotter contains information for thousands of destinations offering marine services.

- 1 Select **Where To > Services**.
- 2 Select **Offshore Services** or **Inland Services**.
- 3 If necessary, select the marine service category.
The chartplotter shows a list of the nearest locations and the distance and bearing to each.
- 4 Select a destination to view more information about the destination, if available.
You can touch and drag up and down to scroll through the list of nearest destinations.

Setting and Following a Direct Course Using Go To

WARNING

When using Go To, a direct course and a corrected course may pass over land or shallow water. Use visual sightings, and steer to avoid land, shallow water, and other dangerous objects.

You can set and follow a direct course from your current location to a selected destination.

- 1 Select a destination ([Destinations, page 47](#)).

2 Select **Navigate To > Go To**.

A magenta line appears. In the center of the magenta line is a thinner purple line that represents the corrected course from your current location to the destination. The corrected course is dynamic, and it moves with your boat when you are off course.

3 Follow the magenta line, steering to avoid land, shallow water, and other obstacles.

4 If you are off course, follow the purple line (corrected course) to go to your destination, or steer back to the magenta line (direct course).

You can also use the orange course-to-steer arrow, which shows a proposed turning radius to return your boat to the course.

WARNING

Review the path for obstacles before negotiating the turn. If the path is unsafe, reduce your boat speed and determine a safe path back to the course.

Stopping Navigation

While navigating, from an applicable chart, select an option:

- Select **⋮ > Stop Navigation**.
- When navigating with Auto Guidance, select **⋮ > Navigation Options > Stop Navigation**.
- Select .

Waypoints

Waypoints are locations you record and store in the device. Waypoints can mark where you are, where you are going, or where you have been. You can add details about the location, such as name, elevation, and depth.

Marking Your Present Location as a Waypoint

From any screen, select **Mark**.

Creating a Waypoint at a Different Location

1 From a chart, select **Where To > Waypoints > New Waypoint**.

2 Select an option:

- To create the waypoint by entering position coordinates, select **Enter Coordinates**, and enter the coordinates.
- To create the waypoint using a chart, select **Use Chart**, select the location, and select **Create Waypoint**.
- To create the waypoint using a range (distance) and bearing, select **Enter Range/Bearing**, and enter the information.

Marking an MOB Location

Select **Mark > Man Overboard**.

An international man overboard (MOB) symbol marks the active MOB point and the chartplotter sets a direct course back to the marked location.

Projecting a Waypoint

You can create a new waypoint by projecting the distance and bearing from a different location. This can be helpful when creating sail racing start and finish lines.

1 Select **Where To > Waypoints > New Waypoint > Enter Range/Bearing**.

2 If necessary, select a reference point on the chart.

3 Select **Enter Range/Bearing**.

4 Enter the distance, and select **Done**.

5 Enter the bearing, and select **Done**.

6 Select **Create Waypoint**.

Viewing a List of all Waypoints

Select an option:

- Select **Where To > Waypoints**.
- From a chart or 3D chart view, select **⋮ > Waypoints**.

Editing a Saved Waypoint

1 Select **Where To > Waypoints**.

- 2 Select a waypoint.
- 3 Select **Review > Edit**.
- 4 Select an option:
 - To add a name, select **Name**, and enter a name.
 - To change the symbol, select **Symbol**.
 - To move the position of the waypoint, select **Position**.
 - To change the depth, select **Depth**.
 - To change the water temperature, select **Water Temp..**
 - To change the comment, select **Comment**.

Moving a Saved Waypoint

- 1 Select **Where To > Waypoints**.
- 2 Select a waypoint.
- 3 Select **Review > Edit > Position**.
- 4 Indicate a new location for the waypoint:
 - To move the waypoint using coordinates, select **Enter Coordinates**, enter the new coordinates, and select **Done** or **Cancel**.
 - To move the waypoint while using the chart, select **Use Chart**, select a new location on the chart, and select **Move Waypoint**.
 - To move the waypoint using the vessel's current position, select **Use Current Position**.
 - To move the waypoint using a range (distance) and bearing, select **Enter Range/Bearing**, enter the information, and select **Done**.

Browsing for and Navigating to a Saved Waypoint

WARNING

All route and navigation lines displayed on the chartplotter are only intended to provide general route guidance or to identify proper channels, and are not intended to be precisely followed. Always defer to the nav aids and conditions on the water when navigating to avoid groundings or hazards that could result in vessel damage, personal injury, or death.

The Auto Guidance feature is based on electronic chart information. That data does not ensure obstacle and bottom clearance. Carefully compare the course to all visual sightings, and avoid any land, shallow water, or other obstacles that may be in your path.

When using Go To, a direct course and a corrected course may pass over land or shallow water. Use visual sightings, and steer to avoid land, shallow water, and other dangerous objects.

NOTE: Auto Guidance is available with premium charts, in some areas.

Before you can navigate to a waypoint, you must create a waypoint.

- 1 Select **Where To > Waypoints**.
- 2 Select a waypoint.
- 3 Select **Navigate To**.
- 4 Select an option:
 - To navigate directly to the location, select **Go To**.
 - To create a route to the location, including turns, select **Route To**.
 - To use Auto Guidance, select **Auto Guidance**.
- 5 Review the course indicated by the magenta line.

NOTE: When using Auto Guidance, a gray segment within any part of the magenta line indicates that Auto Guidance cannot calculate part of the Auto Guidance line. This is due to the settings for minimum safe water depth and minimum safe obstacle height.
- 6 Follow the magenta line, steering to avoid land, shallow water, and other obstacles.

NOTE: In the center of the magenta line is a thinner purple line that represents the direct course from your current location to your destination. The direct course is dynamic, and it moves with your boat when you are off course.

Deleting a Waypoint or an MOB

- 1 Select **Where To > Waypoints**.

- 2 Select a waypoint or an MOB.
- 3 Select **Review > Delete**.

Deleting All Waypoints

Select **Where To > Manage User Data > Delete User Data > Waypoints > All**.

Routes

A route is a path from one location to one or more destinations.

Creating and Navigating a Route From Your Present Location

You can create and immediately navigate a route on the Navigation chart or the Fishing chart. This method does not save the route.

- 1 From the Navigation chart or Fishing chart, select a destination.
- 2 Select **Route To**.
- 3 Select the location of the last turn before the destination.
- 4 Select **Add Turn**.
- 5 If necessary, repeat to add turns, working backward from the destination to the present location of your vessel.

The last turn you add should be the first turn you make, starting from your present location. It should be the turn closest to your vessel.

- 6 Select **Done**.
- 7 Review the course indicated by the magenta line.
- 8 Follow the magenta line, steering to avoid land, shallow water, and other obstacles.

NOTE: In the center of the magenta line is a thinner purple line that represents the direct course from your current location to the next route turn. The direct course is dynamic, and it moves with your boat when you are off course.

Creating and Saving a Route

You can add up to 250 turns to one route.

- 1 Select **Where To > Routes > New > Route Using Chart**.
- 2 Select the starting location of the route.
The starting point can be your present location or another location.
- 3 Select **Add Turn**.
- 4 Select the location of the next turn on the chart.
- 5 Select **Add Turn**.
- 6 If necessary, repeat steps 4 and 5 to add more turns.
- 7 Select **Done**.

Viewing a List of Routes and Auto Guidance Paths

- 1 Select **Where To > Routes**.
- 2 If necessary, select **Filter** to see routes only or Auto Guidance paths only.
- 3 Select **Sort** to sort the list of available routes by range, length, or name.

Editing a Saved Route

You can change the name of a route or change the turns the route contains.

- 1 Select **Where To > Routes**.
- 2 Select a route.
- 3 Select **Review > Edit Route**.
- 4 Select an option:
 - To change the name, select **Name**, and enter the name.
 - To edit a turn from a list, select **Edit Turns > Use Turn List**, and select a turn from the list.
 - To select a turn using the chart, select **Edit Turns > Use Chart**, and select a location on the chart.

Modifying a turn that uses a saved waypoint does not move that waypoint, it relocates the turn in the route. Moving the location of a waypoint used in a route does not move the turn in the route.

Finding and Navigating a Saved Route

Before you can browse a list of routes and navigate to one of them, you must create and save at least one route (*Creating and Saving a Route*, page 50).

- 1 Select **Where To > Routes**.
- 2 Select a route.
- 3 Select **Navigate To**.
- 4 Select an option:
 - To navigate the route from the starting point used when the route was created, select **Forward**.
 - To navigate the route from the destination point used when the route was created, select **Backward**.
 - To navigate parallel to the route, select **Offset** (*Browsing for and Navigating Parallel to a Saved Route*, page 51).
 - To navigate a route from the route's first waypoint, select **From Start**.

A magenta line appears. In the center of the magenta line is a thinner purple line that represents the corrected course from your present location to the destination. The corrected course is dynamic, and it moves with your boat when you are off course.

- 5 Review the course indicated by the magenta line.
- 6 Follow the magenta line along each leg in the route, steering to avoid land, shallow water, and other obstacles.
- 7 If you are off course, follow the purple line (corrected course) to go to your destination, or steer back to the magenta line (direct course).

Browsing for and Navigating Parallel to a Saved Route

Before you can browse a list of routes and navigate to one of them, you must create and save at least one route (*Creating and Saving a Route*, page 50).

- 1 Select **Where To > Routes**.

Auto Guidance is available with premium charts, in some areas.
- 2 Select a route.
- 3 Select **Navigate To**.
- 4 Select **Offset** to navigate parallel to the route.
- 5 Select **Offset** to enter the distance to offset from the route.
- 6 Indicate how to navigate the route:
 - To navigate the route from the starting point used when the route was created, to the left of the original route, select **Forward - Port**.
 - To navigate the route from the starting point used when the route was created, to the right of the original route, select **Forward - Starboard**.
 - To navigate the route from the destination point used when the route was created, to the left of the original route, select **Backward - Port**.
 - To navigate the route from the destination point used when the route was created, to the right of the original route, select **Backward - Starboard**.

- 7 If necessary, select **Done**.

A magenta line appears. In the center of the magenta line is a thinner purple line that represents the corrected course from your present location to the destination. The corrected course is dynamic, and it moves with your boat when you are off course.
- 8 Review the course indicated by the magenta line.
- 9 Follow the magenta line along each leg in the route, steering to avoid land, shallow water, and other obstacles.
- 10 If you are off course, follow the purple line (corrected course) to go to your destination, or steer back to the magenta line (direct course).

Initiating a Search Pattern

You can initiate a search pattern to search an area. Different patterns are better suited for different search situations.

- 1 Select **Where To > Routes > New > Route Using SAR Pattern**.
- 2 Select a pattern:

- Select **Sector Search** when the location of the object is fairly known, the search area is small, and an intensive search is needed.
- Select **Expanding Square** when the location of the object is somewhat doubtful, the search area is small, and an intensive search is needed.
- Select **Creeping/Parallel Line** when the location of the object is approximate, the search area is small, and a consistent search is needed.

3 Enter the search parameters.

4 Select **Done**.

5 If necessary, select **Engage**.

Deleting a Saved Route

1 Select **Where To > Routes**.

2 Select a route.

3 Select **Review > Delete**.

Deleting All Saved Routes

Select **Where To > Manage User Data > Delete User Data > Routes**.

Auto Guidance

WARNING

The Auto Guidance feature is based on electronic chart information. That data does not ensure obstacle and bottom clearance. Carefully compare the course to all visual sightings, and avoid any land, shallow water, or other obstacles that may be in your path.

All route and navigation lines displayed on the chartplotter are only intended to provide general route guidance or to identify proper channels, and are not intended to be precisely followed. Always defer to the nav aids and conditions on the water when navigating to avoid groundings or hazards that could result in vessel damage, personal injury, or death.

NOTE: Auto Guidance is available with premium charts, in some areas.

You can use Auto Guidance to plot the best path to your destination. Auto Guidance uses your chartplotter to scan chart data, such as water depth and known obstacles, to calculate a suggested path. You can adjust the path during navigation.

Setting and Following an Auto Guidance Path

1 Select a destination ([Destinations, page 47](#)).

2 Select **Navigate To > Auto Guidance**.

3 Review the path, indicated by the magenta line.

4 Select **Start Navigation**.

5 Follow the magenta line, steering to avoid land, shallow water, and other obstacles ([Route Color Coding, page 47](#)).

NOTE: When using Auto Guidance, a gray segment within any part of the magenta line indicates that Auto Guidance cannot calculate part of the Auto Guidance line. This is due to the settings for minimum safe water depth and minimum safe obstacle height.

Creating and Saving an Auto Guidance Path

1 Select **Where To > Routes > New > Auto Guidance**.

2 Select a starting point, and select **Next**.

3 Select a destination, and select **Next**.

4 Select an option:

- To view a hazard and adjust the path near a hazard, select **Hazard Review**.
- To adjust the path, select **Adjust Path**, and follow the on-screen instructions.
- To delete the path, select **Cancel Auto Guidance**.
- To save the path, select **Done**.

Adjusting a Saved Auto Guidance Path

1 Select **Where To > Routes & Auto Guidance**.

2 Select a path, and select **Review > Edit > Adjust Path**.

TIP: When navigating an Auto Guidance path, select the path on the navigation chart, and select Adjust Path.

- 3 Select a location on the path.
- 4 Drag the point to a new location.
- 5 If necessary, select a point, and select **Remove**.
- 6 Select **Done**.

Canceling an Auto Guidance Calculation in Progress

From the Navigation chart, select **⋮ > Cancel**.

TIP: You can select Back to quickly cancel the calculation.

Setting a Timed Arrival

You can use this feature on a route or an Auto Guidance path to get feedback about when you should arrive at a selected point. This allows you to time your arrival at a location, such as a bridge opening or a race starting line.

- 1 From the Navigation chart, select **⋮**.
- 2 Select **Navigation Options > Timed Arrival**.

TIP: You can quickly open the Timed Arrival menu by selecting a point on the path or route.

Auto Guidance Path Configurations

CAUTION

The Preferred Depth and Vertical Clearance settings influence how the chartplotter calculates an Auto Guidance path. If a section of an Auto Guidance path is shallower than the Preferred Depth or lower than the Vertical Clearance settings, the section of the Auto Guidance path appears as a solid orange line or a red striped line in Garmin Navionics™ and Garmin Navionics Vision+™ charts and appears as a magenta and gray striped line in previous versions. When your boat enters one of those areas, a warning message appears ([Route Color Coding, page 47](#)).

NOTE: Auto Guidance is available with premium charts, in some areas.

Not all settings apply to all maps.

You can set the parameters the chartplotter uses when calculating an Auto Guidance path.

Select  **> Preferences > Navigation > Auto Guidance**.

Preferred Depth: Sets the minimum water depth, based on chart depth data, that your boat can safely travel over.

NOTE: The minimum water depth for the premium charts (made before 2016) is 3 feet. If you enter a value of less than 3 feet, the charts only use depths of 3 feet for Auto Guidance path calculations.





Vertical Clearance: Sets the minimum height of a bridge or obstacle, based on chart data, that your boat can safely travel under.

Shoreline Distance: Sets how close to the shore you want the Auto Guidance path to be placed. The path may move if you change this setting while navigating. The available values for this setting are relative, not absolute. To ensure that path is placed the appropriate distance from shore, you can assess the placement of the path using one or more familiar destinations that require navigation through a narrow waterway ([Adjusting the Distance from Shore, page 53](#)).

Adjusting the Distance from Shore

The Shoreline Distance setting indicates how close to the shore you want the Auto Guidance line to be placed. The Auto Guidance line may move if you change this setting while navigating. The available values for the Shoreline Distance setting are relative, not absolute. To ensure the Auto Guidance line is placed the appropriate distance from shore, you can assess the placement of the Auto Guidance line using one or more familiar destinations that require navigation through a narrow waterway.

- 1 Dock your vessel or drop the anchor.
- 2 Select  **> Preferences > Navigation > Auto Guidance > Shoreline Distance > Normal**.
- 3 Select a destination that you have navigated to previously.
- 4 Select **Navigate To > Auto Guidance**.
- 5 Review the placement of the **Auto Guidance** line, and determine whether the line safely avoids known obstacles and the turns enable efficient travel.
- 6 Select an option:
 - If the placement of the line is satisfactory, select **⋮ > Navigation Options > Stop Navigation**, and proceed to step 10.

- If the line is too close to known obstacles, select  > **Preferences > Navigation > Auto Guidance > Shoreline Distance > Far.**
 - If the turns in the line are too wide, select  > **Preferences > Navigation > Auto Guidance > Shoreline Distance > Near.**
- 7 If you selected **Near** or **Far** in step 6, review the placement of the **Auto Guidance** line, and determine whether the line safely avoids known obstacles and the turns enable efficient travel.
- Auto Guidance maintains a wide clearance from obstacles in open water, even if you set the Shoreline Distance setting to Near or Nearest. As a result, the chartplotter may not reposition the Auto Guidance line, unless the destination selected requires navigation through a narrow waterway.
- 8 Select an option:
- If the placement of the line is satisfactory, select **...** > **Navigation Options > Stop Navigation**, and proceed to step 10.
 - If the line is too close to known obstacles, select  > **Preferences > Navigation > Auto Guidance > Shoreline Distance > Farthest.**
 - If the turns in the line are too wide, select  > **Preferences > Navigation > Auto Guidance > Shoreline Distance > Nearest.**
- 9 If you selected **Nearest** or **Farthest** in step 8, review the placement of the **Auto Guidance** line, and determine whether the line safely avoids known obstacles and the turns enable efficient travel.
- The Auto Guidance path maintains a wide clearance from obstacles in open water, even if you set the Shoreline Distance setting to Near or Nearest. As a result, the chartplotter may not reposition the Auto Guidance line, unless the destination selected requires navigation through a narrow waterway.
- 10 Repeat steps 3 through 9 at least once more, using a different destination each time, until you are familiar with the functionality of the **Shoreline Distance** setting.

Tracks

A track is a recording of the path of your boat. The track currently being recorded is called the active track, and it can be saved. You can show tracks in each chart or 3D chart view.

Showing Tracks

- 1 From a chart, select **...** > **Layers > Manage User Data > Tracks.**
 - 2 Select the tracks to display.
- A trailing line on the chart indicates your track.

Setting the Color of the Active Track

- 1 Select **Where To > Tracks > Active Track Options > Track Color.**
- 2 Select a track color.

Saving the Active Track

The track currently being recorded is called the active track.

- 1 Select **Where To > Tracks > Save Active Track.**
- 2 Select an option:
 - Select the time the active track began.
 - Select **Entire Log.**
- 3 Select **Save.**

Viewing a List of Saved Tracks

Select **Where To > Tracks > Saved Tracks.**

Editing a Saved Track

- 1 Select **Where To > Tracks > Saved Tracks.**
- 2 Select a track.
- 3 Select **Review > Edit Track.**
- 4 Select an option:
 - Select **Name**, and enter the new name.
 - Select **Track Color**, and select a color.
 - Select **Save as Route** to save the track as a route.

- Select **Save as Boundary** to save the track as a boundary.

Saving a Track as a Route

- 1 Select **Where To > Tracks > Saved Tracks**.
- 2 Select a track.
- 3 Select **Review > Edit Track > Save as Route**.

Browsing for and Navigating a Recorded Track

Before you can browse a list of tracks and navigate to them, you must record and save at least one track.

- 1 Select **Where To > Tracks > Saved Tracks**.
- 2 Select a track.
- 3 Select **Follow Track**.
- 4 Select an option:
 - To navigate the track from the starting point used when the track was created, select **Forward**.
 - To navigate the track from the destination point used when the track was created, select **Backward**.
- 5 Review the course indicated by the colored line.
- 6 Follow the line along each leg in the route, steering to avoid land, shallow water, and other obstacles.

Deleting a Saved Track

- 1 Select **Where To > Tracks > Saved Tracks**.
- 2 Select a track.
- 3 Select **Review > Delete**.

Deleting All Saved Tracks

Select **Where To > Manage User Data > Delete User Data > Saved Tracks**.

Retracing the Active Track

The track currently being recorded is called the active track.

- 1 Select **Where To > Tracks > Follow Active Track**.
- 2 Select an option:
 - Select the time the active track began.
 - Select **Entire Log**.
- 3 Review the course indicated by the colored line.
- 4 Follow the colored line, steering to avoid land, shallow water, and other obstacles.

Clearing the Active Track

Select **Where To > Tracks > Clear Active Track**.

The track memory is cleared, and the active track continues to be recorded.

Managing the Track Log Memory During Recording

- 1 Select **Where To > Tracks > Active Track Options**.
- 2 Select **Record Mode**.
- 3 Select an option:
 - To record a track log until the track memory is full, select **Fill**.
 - To continuously record a track log, replacing the oldest track data with new data, select **Wrap**.

Configuring the Recording Interval of the Track Log

You can indicate the frequency at which the track plot is recorded. Recording more frequent plots is more accurate but fills the track log faster. The resolution interval is recommended for the most efficient use of memory.

- 1 Select **Where To > Tracks > Active Track Options > Interval > Interval**.
- 2 Select an option:
 - To record the track based on a distance between points, select **Distance > Change**, and enter the distance.
 - To record the track based on a time interval, select **Time > Change**, and enter the time interval.

- To record the track plot based on a variance from your course, select **Resolution > Change**, and enter the maximum error allowed from the true course before recording a track point. This is the recommended recording option.

Boundaries

⚠ WARNING

This feature is a tool for situational awareness only and may not prevent groundings or collisions in all circumstances. It is your obligation to ensure safe operation of your vessel.

⚠ CAUTION

The Beeper setting must be turned on to make alarms audible (*Sounds and Display Settings, page 152*). Failure to set audible alarms could lead to injury or property damage.

Boundaries allow you to avoid or remain in designated areas in a body of water. You can set an alarm to alert you when you enter or exit a boundary.

You can create boundary areas, lines, and circles using the map. You can also convert saved tracks and routes into boundary lines. You can create a boundary area using waypoints by creating a route from the waypoints, and converting the route into a boundary line.

You can select a boundary to act as the active boundary. You can add the active boundary data to the data fields on the chart.

Creating a Boundary

- 1 Select **Where To > Boundaries > New**.
- 2 Select a boundary shape.
- 3 Follow the on-screen instructions.

Converting a Route to a Boundary

- 1 Select **Where To > Routes**.
- 2 Select a route.
- 3 Select **Review > Edit Route > Save as Boundary**.

Converting a Track to a Boundary

- 1 Select **Where To > Tracks > Saved Tracks**.
- 2 Select a track.
- 3 Select **Review > Edit Track > Save as Boundary**.

Editing a Boundary

- 1 Select **Where To > Boundaries**.
- 2 Select a boundary.
- 3 Select **Review**.
- 4 Select an option:
 - To edit the appearance of the boundary on the chart, select **Display Options**.
 - To change the boundary lines or name, select **Edit Boundary**.
 - To edit the boundary alarm, select **Alarm**.

Setting a Boundary Alarm

Boundary alarms alert you when you are within a specified distance of a set boundary. This can be helpful when attempting to avoid certain areas or when you should be very alert in certain areas.

- 1 Select **Where To > Boundaries**.
- 2 Select a boundary.
- 3 Select **Review > Alarm**.
- 4 Select an option:
 - To set an alarm for when your boat is a specified distance from the boundary, select **Warning Dist.**, enter a distance, and select **Done**.
 - To set an alarm for when you enter or exit an area boundary or a circle boundary, select **Area** to show **Entering** or **Exiting**.

Disabling all Boundary Alarms

Select **Where To** > **Manage User Data** > **Boundaries** > **Alarms**.

Deleting a Boundary

- 1 Select **Where To** > **Boundaries**.
- 2 Select a boundary.
- 3 Select **Review** > **Edit Boundary** > **Delete**.

Deleting All Saved Waypoints, Tracks, Routes, and Boundaries

Select **Where To** > **Manage User Data** > **Delete User Data** > **Delete All User Data** > **OK**.

Sailing Features

Setting the Vessel Type for Sailing Features

You must select a sailing vessel type to use the sailing features.

- 1 Select  > **My Vessel** > **Vessel Type**.
- 2 Select **Sailboat** or **Sailing Catamaran**.

Sail Racing

You can use the device to increase the likelihood that your boat will cross the start line of a race exactly when the race begins. When you synchronize the race timer with the official race countdown timer, you are alerted at one-minute intervals as the race start approaches. When you combine the race timer with the virtual start line, the device measures your speed, bearing, and remaining time on the countdown timer. The device uses this data to indicate whether your boat will cross the start line before, after, or at the correct time to start the race.



Starting Line Guidance

Sailing start line guidance is a visual representation of the information you need to cross the start line at the optimal time and speed.

By default, the start line guidance window and the race timer window appear in the Sail Racing combination screen.

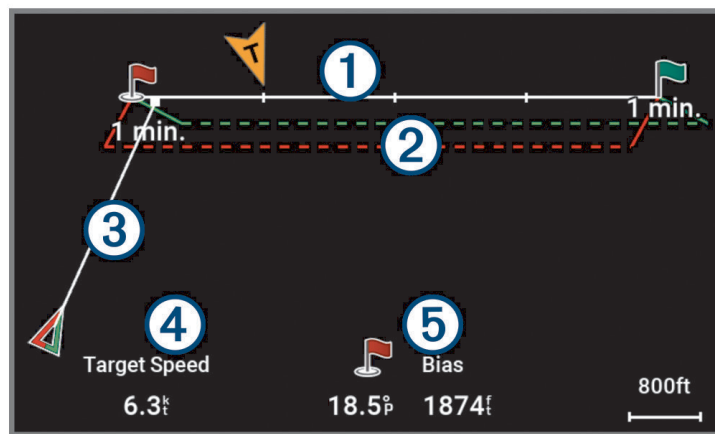
Before you can view the starting line guidance information, you must define the port and starboard points of the start line ([Setting the Starting Line, page 59](#)).



	Port and starboard points of the start line.
	Start line bias point. See 5 below.
1	Start line indicator. This line is defined by the port and starboard points you specify.
2	Port and starboard laylines. The solid lines show the laylines in relation to each start point.
3	Predictor line. This appears after you define the port and starboard pins, the target speed and time, and you start the race timer. The end point and color of the predictor line indicate where the boat will be when the timer expires, based on your current boat speed. <ul style="list-style-type: none">• When the end point is before the start line, the line is white. This indicates the boat must increase speed to reach the start line on time.• When the end point is past the start line, the line is red. This indicates the boat must reduce speed to avoid a penalty for reaching the start line before the timer expires.• When the end point is on the start line, the line is white. This indicates the boat is moving at an optimal speed to reach the start line when the timer expires.
4	Desired speed when crossing the start line or Target Speed from the polar table.
5	Start line bias information. This indicates which end of the start line, port or starboard, you should try to target when approaching so you can cross the starting line at the fastest speed based on present wind and other conditions.

Using the Starting Line Guidance

You can use the starting line guidance feature to help get you cross the start line, at the optimal speed during a sailing race.

- 1 Mark the starting line (*Setting the Starting Line, page 59*).
- 2 From the Sail Racing combination screen, select **•••** > **Start Line Guidance** > **Target Speed**, and select your target speed when crossing the starting line.
TIP: You do not have to set your target speed if you have loaded a polar table (*Polar Tables, page 60*).
- 3 Select **Target Time**, and select the target time to cross the starting line.
- 4 Select **Back**.
- 5 Start the racing timer (*Starting the Race Timer, page 59*).

Setting the Starting Line

The start line guidance window is added to the Sail Racing combination screen by default.

- 1 From the Sail Racing combination screen, select **•••** > **Start Line Guidance** > **Start Line**.
- 2 Select an option:
 - To mark the port and starboard starting line marks as you sail past them, select **Ping Marks**.
 - To mark the port and starboard starting line marks by entering their coordinates, select **Enter Coordinates**.
 - To switch the position of the port and starboard marks after you have set them, select **Swap Port & Starbd.**

If you are not located near the starting line and do not know the coordinates, you can set the starting line using the chart.

Setting the Starting Line from the Navigation Chart

If you are not located near the starting line and do not know its coordinates, or if you know the landmarks associated with the starting line, you can set the starting line by establishing points on the chart.

- 1 From the Navigation Chart, touch any location to open the banner on the top of the chart.
- 2 In the banner, select **Start Line**.
- 3 Select an option to define one of the end points for the starting line:
 - Touch or drag to a point on the map using a landmark or other identifying chart feature.
 - If you know the distance and bearing from your location, select **Enter Range/Bearing** and enter the values for the range and bearing from your location on the chart.
- 4 Select **Select Port Mark** or **Select Starboard Mark** to define the first point of the starting line.
- 5 Select an option to define the other end point for the starting line:
 - Touch or drag to a point on the map using a landmark or other identifying chart feature.
 - If you know the distance and bearing from one starting point to the other, select **Enter Range/Bearing** and enter the values for the range and bearing.
- 6 Select **Select Port Mark** or **Select Starboard Mark** to define the second point of the starting line.
TIP: If you accidentally selected the wrong label for the port and starboard points, you can select **Swap Port & Starbd.** to change them.
- 7 Select **Done**.

Starting the Race Timer

The race timer is added to the Sail Racing combination screen by default.

- 1 From the Sail Racing combination screen, select **Start**.
- 2 When necessary, select **Sync** to synchronize with the official race timer.

Stopping the Race Timer

From the Sail Racing combination screen, select **Stop**.

Setting the Distance between the Bow and the GPS Antenna

You can enter the distance between the bow of your boat and the location of your GPS antenna. This helps ensure the bow of your boat crosses the starting line at the precise start time.

- 1 From the Sail Racing combination screen, select **•••** > **Start Line Guidance** > **Start Line** > **GPS Bow Ofst.**
- 2 Enter the distance.
- 3 Select **Done**.

Sailing Navigation Chart Presets

You can select a sailing-specific preset on the navigation chart to quickly adjust chart elements such as laylines and the wind rose to display the information most relevant to your needs in specific situations. These presets behave in the same way as other chart presets, but are available only when using a sailing vessel ([Presets](#), page 18).

Sailing: Laylines, Points of Interest (POIs), and the wind rose are all shown. The chart is set to north up orientation.

Sail Racing: Laylines and the wind rose are shown, but POIs are hidden. The chart is set to north up orientation.

Motoring: Laylines and the wind rose are hidden, but POIs are shown. The chart is set to head up orientation.

Laylines Settings

To use the laylines features, you must connect a wind sensor to the chartplotter.

When in sailing mode ([Setting the Vessel Type for Sailing Features](#), page 58), you can display laylines on the navigation chart. Laylines can be very helpful when racing.

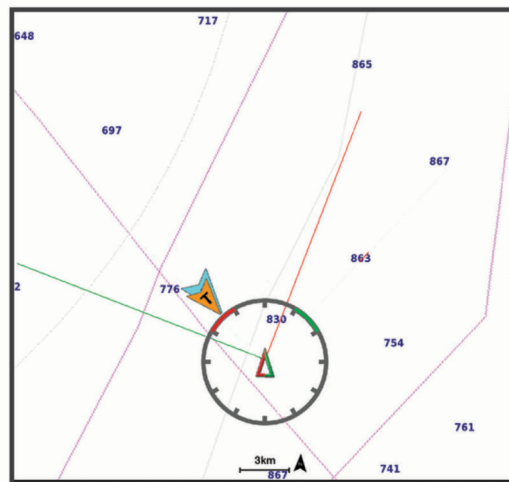

From the Navigation chart, select **••• > Layers > My Vessel > Laylines > Setup**.

Sailing Ang.: Allows you to select how the device calculates laylines. The Actual option calculates the laylines using the measured wind angle from the wind sensor. The Manual option calculates the laylines using manually entered windward and leeward angles. The Polar Table option calculates the laylines based on the imported polar table data ([Importing a Polar Table Manually](#), page 61).

Windward Ang.: Allows you to set a layline based on the windward sailing angle.

Leeward Ang.: Allows you to set a layline based on the leeward sailing angle.

Layline Filter: Filters the layline data based on the time interval entered. For a smoother layline that filters out some of the changes in the boat's heading or true wind angle, enter a higher number. For laylines that display a higher sensitivity to changes in the boat's heading or true wind angle, enter a lower number.

Polar Tables

WARNING

This feature allows you to load and use data from a third party. Garmin® makes no representations about the accuracy, reliability, completeness or timeliness of the data generated by third parties. Any use or reliance on data generated by third parties is at your own risk.

You can use polar table data with your chartplotter. You can assign polar data types in data fields, and you can use polar data to calculate optimal laylines and starting line guidance.

The chartplotter is preloaded with a set of polar table data you can use. You can also upload a custom polar-table data file.

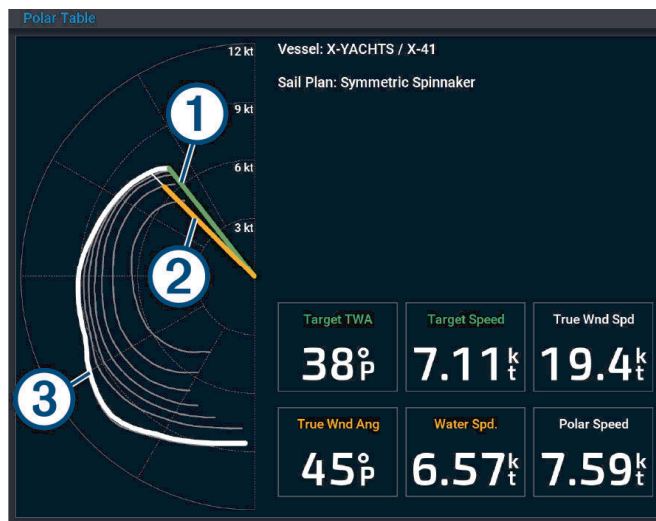

①	Target wind speed and angle, where the length of the line indicates the speed
②	Measured speed and angle, the length of the line indicates the speed
③	Curve from the polar table that matches the measured wind speed

Selecting a Preloaded Polar Table

You can select from a number of polar tables preloaded on the chartplotter.

- 1 Select **⚙️ > My Vessel > Polar Table > Select Polar Table**.
- 2 Select a polar table from the list.

Importing a Polar Table Manually

If you save the polar table file as polar.plr and place it in the Garmin/polars/ folder on the memory card, the chartplotter imports the data automatically after you insert the memory card. If it does not import the data automatically, or if you want to load a different set of data, you can initiate the import manually.

- 1 Save the polar table as a .plr file in the Garmin/polars/ folder on the memory card.
- 2 Insert the memory card containing the polar data file into the chartplotter ([Inserting Memory Cards, page 14](#)).
- 3 Select **⚙️ > My Vessel > Polar Table > Select Polar Table > Import from Card**.
- 4 If necessary, select the card slot and the polar table file.

After the polar table is imported, you can remove the memory card.

If you need to import a different set of polar tables based on your sailing plans or conditions, you must manually import the new polar-table data. The chartplotter supports one set of data at a time.

Viewing Polar Table Details

After you have selected or loaded a polar table, you can view detailed information about the target wind speed and angles in the polar data.

- 1 Select **⚙️ > My Vessel > Polar Table > View Details**.
- 2 Select the data you want to view at various points in the polar table.

Showing Polar Data in Data Fields

Before you can view polar data, you must select or import a polar table.

- 1 Open the screen to which you want to add polar data.
- 2 Perform an action.
 - If there is no polar data in a data field and you'd like to add it, select **⋮ > Edit Overlays**, then select the data field where you want to add the data.
 - If polar data is present in a data field and you want to change it, press and hold the data field you want to change, then select **Replace Data**.
- 3 Select **Sailing**.
- 4 Select the polar data to display in the data field.
 - To show the boat speed from the polar table at the current true wind speed and angle, select **Polar Speed**.

- To show the optimal boat speed at the target wind angle, select **Target Speed**.
- To show the optimal wind angle at the current true wind speed, select **Target True Wind Angle**.
- To show Target TWA converted to apparent using target speed, select **Target App. Wind Angle**.
- To show the difference between the current boat speed and the optimal boat speed shown as speed, select **Δ Polar Speed**.
- To show the difference between the current boat speed and the optimal boat speed as a percentage, select **Δ Polar Speed Percent**.
- To show the difference between the current boat speed and the target boat speed shown as speed, select **Δ Target Speed**.
- To show the difference between the current boat speed and the target boat speed shown as a percentage, select **Δ Target Speed Percent**.
- To show the difference between the true wind angle and target true wind angle, select **Δ Target True Wind Angle**.
- To show the difference between the apparent wind angle and target apparent wind angle and the true wind angle, select **Δ Target App. Wind Angle**.

TIP: You can also use the polar table data when calculating laylines and starting line guidance.

Adjusting the Scale of the Polar Table

You can adjust the scale of the polar table to adjust the accuracy for your vessel or to accommodate changes such as replacing or changing the sails. The scale setting reflects across the entire system, so it adjusts all polar table information in data fields and connected devices.

- 1 Select **⚙️ > My Vessel > Polar Table**.
- 2 Select **Scale Factor**.
- 3 Select **⋮**, and adjust the scale up or down as needed.

Turning Off Polar Table Data

After you have selected or loaded polar table data, you may want to turn it off so it is not available in the system.

- 1 Select **⚙️ > My Vessel > Polar Table**.
- 2 Select **Polar Table** to turn off the feature.

You can select Polar Table to turn the feature back on again.

Steer Assist

⚠️ WARNING

You are responsible for the safe and prudent operation of your vessel. Steer assist is a feature that can provide information on steering your vessel. It does not control the helm for you or relieve you of the responsibility of safely operating your boat. Avoid navigational hazards and never leave the helm unattended.

Steer Assist is a set of sailing features provided to help you steer on the optimal course while sailing. You must select or import a polar table before you can use the Steer Assist feature ([Polar Tables, page 60](#)).

Steer Assist is enabled automatically when you select or load a polar table. To deactivate Steer Assist, select **⚙️ > Preferences > Navigation > Steer Assist**.

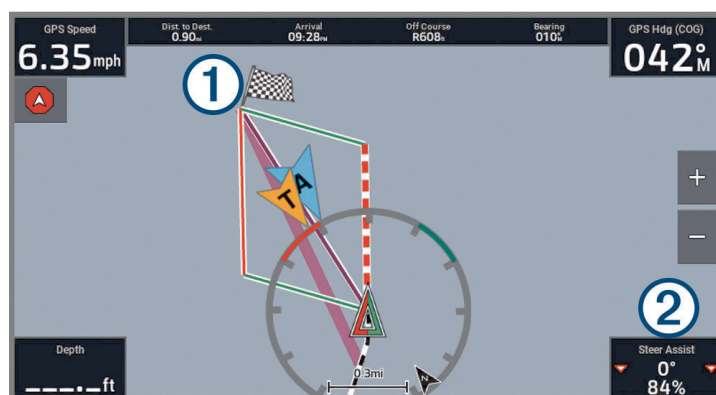

- ① Navigation turn or destination:
 - The wide magenta line indicates the initial route line to the next turn or the destination.
 - The thin purple line from your vessel to the next turn or to the destination indicates your present bearing to the next turn or to the destination.
 - The port and starboard laylines are determined by the polar table you are using.
 - The bold dashed line (can be red, green, or purple) indicates the recommended Steer Assist bearing to follow.
- ② Steer Assist data field:
 - The first number listed indicates how you should turn to align with the suggested optimal course for the present maneuver. A value of 0° indicates that you are on course.
 - The percentage indicates your present speed as compared to the ideal speed for the conditions. If the number is lower than 100%, you should consider adjusting the trim to increase your speed.
 - The triangle or triangles on the side also provide guidance based on the color and shading:
 - A red triangle or triangles indicate that you are aligned with the port layline.
 - A green triangle or triangles indicate that you are aligned with the starboard layline.
 - A magenta triangle or triangles indicate that you are aligned with the bearing to the next turn or destination.
 - A triangle with a white center indicates that you are within 3° of the optimal course and should maintain your heading.
 - A solid triangle or triangles indicate that you are off course by more than 3° and should adjust your heading.

Setting the Keel Offset

You can enter a keel offset to compensate the water depth reading for the transducer installation location. This allows you to view the depth of the water below the keel or the true depth of the water, depending on your needs.

If you want to know the water depth below the keel or the lowest point of your boat and the transducer is installed at the water line or anywhere above the end of the keel, measure the distance from the transducer location to the keel of the boat.

If you want to know the true water depth and the transducer is installed below the water line, measure the distance from the bottom of the transducer up to the water line.

NOTE: This option is only available when you have valid depth data.

1 Measure the distance:

- If the transducer is installed at the water line ① or anywhere above the end of the keel, measure the distance from the transducer location to the keel of the boat. Enter this value as a positive number.
- If the transducer is installed at the bottom of the keel ② and you want to know the true depth of the water, measure the distance from the transducer to the water line. Enter this value in as a negative number.

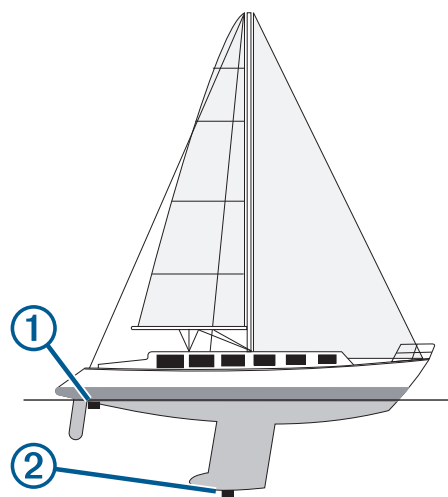

2 Complete an action:

- If the transducer is connected to the chartplotter or a sonar module, select **⚙️ > My Vessel > Depth and Anchoring > Keel Offset**.
- If the transducer is connected to the NMEA 2000® network, select **⚙️ > Communications > NMEA 2000 Setup > Device List**, select the transducer, and select **Review > Keel Offset**.

- 3 Select **+** if the transducer is installed at the water line, or select **-** if the transducer is installed at the bottom of the keel.
- 4 Enter the distance measured in step 1.

Sailboat Autopilot Operation

⚠ WARNING

You are responsible for the safe and prudent operation of your vessel. The autopilot is a tool that enhances your capability to operate your boat. It does not relieve you of the responsibility of safely operating your boat. Avoid navigational hazards and never leave the helm unattended

⚠ CAUTION



When engaged, the autopilot controls only the rudder. You and your crew remain responsible for the sails while the autopilot is engaged.

In addition to heading hold, you can use the autopilot to maintain a wind hold. You can also use the autopilot to control the rudder while tacking and gybing.

Wind Hold

You can set the autopilot to maintain a specific bearing relative to the apparent or true wind angle. You must connect a compatible wind sensor the same NMEA 2000® network as the autopilot system to perform a wind hold or wind-based steering maneuvers.



①	Autopilot status information Standby and  appear in gray when the autopilot is in standby mode. Wind Hold and  appear in green when the autopilot is engaged in wind hold.
②	Wind gauge Shows the true wind speed (TWS) or apparent wind speed (AWS)
③	Rudder position indicator NOTE: This functionality is available only when a rudder sensor is connected.

Changing the Wind Hold Type

With the wind hold engaged, select **⋮ > Wind Hold Type**.

The wind hold type changes from Apparent to True, or vice versa.

Engaging Wind Hold

Before you can engage wind hold, you must connect a NMEA 2000® wind sensor to the autopilot.

- 1 When the autopilot is in standby mode, select **⋮**.
- 2 Select an option:
 - To engage an apparent wind hold, select **Engage App. Wind Hold**.
 - To engage a true wind hold, select **Engage True Wind Hold**.

TIP: You can quickly engage the last type of wind hold used by selecting Wind Hold from standby mode.

Engaging Wind Hold from Heading Hold

Before you can engage wind hold, you must connect a NMEA 2000® wind sensor to the autopilot.

- 1 With heading hold engaged, select **•••**.
- 2 Select an option:
 - To change from heading hold to apparent wind hold, select **Engage App. Wind Hold**.
 - To change from heading hold to true wind hold, select **Engage True Wind Hold**.

Adjusting the Wind Hold Angle

You can adjust the wind hold angle on the autopilot when wind hold is engaged.

- To adjust the wind hold angle in increments of 1°, select **<1° or 1°>**.
NOTE: Holding **<1° or 1°>** for a few seconds automatically transitions the autopilot from Wind Hold to Heading Hold and initiates rudder steering.
- To adjust the wind hold angle in increments of 10°, select **<<10° or 10°>>**.
You can adjust the settings so that the step turn size is smaller or larger than 10° [Adjusting the Step Steering Increment](#), page 90.

Tack and Gybe

You can set the autopilot to perform a tack or gybe while heading hold or wind hold is engaged.

Tacking and Gybing from Heading Hold

- 1 Engage a heading hold ([Engaging the Autopilot](#), page 91).
- 2 Select **•••**.
- 3 Select an option.
The autopilot steers your boat through a tack or gybe.

Tacking and Gybing from Wind Hold

Before you can engage wind hold, you must have a wind sensor installed.

- 1 Engage wind hold ([Engaging Wind Hold](#), page 64).
- 2 Select **•••**.
- 3 Select an option.
The autopilot steers your boat through a tack or gybe, and information about the progress of the tack or gybe appears on the screen.

Setting a Tack Delay

The tack delay allows you to delay steering a tack after you initiate the maneuver.

- 1 From the autopilot screen, select **••• > Autopilot Setup > Sailing Setup > Tack Delay**.
- 2 Select the length of the delay.
- 3 If necessary, select **Done**.

Enabling the Gybe Inhibitor

NOTE: The gybe inhibitor does not prevent you from manually performing a gybe using the helm or step steering.

The gybe inhibitor prevents the autopilot from performing a gybe.

- 1 From the autopilot screen, select **••• > Autopilot Setup > Sailing Setup > Gybe Inhibitor**.
- 2 Select **Enabled**.

Adjusting the Tack and Gybe Speed

You can adjust the turn rate speed when performing tack and gybe maneuvers. You can adjust the speed for each maneuver separately.

- 1 From the autopilot screen, select **••• > Autopilot Setup > Sailing Setup**.
- 2 Select **Tack Speed** or **Gybe Speed**, and adjust the speed.
The higher you set the speed, the faster the turn rate during the maneuver.
NOTE: The turn rate is also affected by the vessel speed.

Heading Line and Angle Markers

The heading line is an extension drawn on the map from the bow of the boat in the direction of travel. Angle markers indicate relative position from the heading or course over ground, which are helpful for casting or finding reference points.

Setting the Heading Line and Angle Markers

The heading line is an extension drawn on the map from the bow of the boat in the direction of travel. Angle markers indicate relative position from the heading or course over ground, which are helpful for casting or finding reference points.

You can show the heading line and the course over ground (COG) line on the chart.

COG is your direction of movement. Heading is the direction the bow of the boat is pointed, when a heading sensor is connected.

- 1 From a chart, select **☰ > Layers > My Vessel > Heading Line > Angle Markers**.
- 2 If necessary, select **Source**, and select an option:
 - To automatically use the available source, select **Auto**.
 - To use the GPS antenna heading for COG, select **GPS Heading (COG)**.
 - To use data from a connected heading sensor, select **Heading**.
 - To use data from both a connected heading sensor and the GPS antenna, select **COG and Heading**.
This displays both the heading line and the COG line on the chart.
- 3 Select **Display**, and select an option:
 - Select **Distance > Distance**, and enter the length of the line shown on the chart.
 - Select **Time > Time**, and enter the time used to calculate the distance your boat will travel in the specified time at your present speed.

Viewing Sailing Vessel Data

After you have connected a compatible device, such as the MSC™ 10 compass, you can view vessel data, such as heave, pitch, and heel.

- 1 Select an option based on the type of screen you are viewing:
 - From a full screen view, select **☰ > Edit Overlays**.
 - From a combination screen, select **☰ > Edit Combo > Overlays**.

TIP: To quickly change the data shown in an overlay box, hold the overlay box.
- 2 Select **Data**.
- 3 Select the data to add to the page, such as **Heave, Trim (Pitch),** or **Heel Angle**.

Sonar Fishfinder

When properly connected to a compatible transducer, your chartplotter can be used as a fishfinder.

For more information about which transducer is best for your needs, go to garmin.com/transducers.

Different sonar views can help you view the fish in the area. The sonar views available vary depending on the type of transducer and sonar module connected to the chartplotter. For example, you can view certain Panoptix™ sonar screens only if you have a compatible Panoptix transducer connected.

There are four basic styles of sonar views available: a full-screen view, a split-screen view that combines two or more views, a split-zoom view, and a split-frequency view that displays two different frequencies. You can customize the settings for each view in the screen. For example, if you are viewing the split-frequency view, you can separately adjust the gain for each frequency.

If you do not see an arrangement of sonar views to suit your needs, you can create a custom combination screen (*Creating a New Combination Page, page 17*).

Stopping the Transmission of Sonar Signals

- To disable the active sonar, from the sonar screen, select **••• > Transmit**.
- To disable all sonar transmissions, press , and select **Disable All Sonar Trans..**

Traditional Sonar View

There are several full-screen views available, depending on the transducer that is connected.

The full-screen Traditional sonar view shows a large image of the sonar readings from a transducer. The range scale along the right side of the screen shows the depth of detected objects as the screen scrolls from the right to the left.

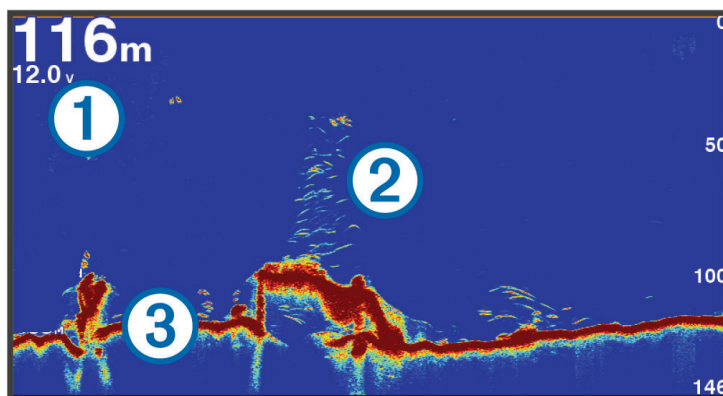

①	Depth information
②	Suspended targets or fish
③	Bottom of the body of water

Split-Frequency Sonar View

In the split-frequency sonar view, the two sides of the screen show a full-view graph of sonar data of different frequencies. You can use this view if you have installed multiple transducers or a transducer that supports multiple frequencies.

NOTE: When using a single-band CHIRP transducer connected to a supported chartplotter or sonar module, the split-frequency sonar view alternates between the two frequencies, which slows the scroll speed. A channel indicator appears next to the sonar frequency on each side of the screen to help identify this behavior.

Garmin ClearVü™ Sonar View

To receive Garmin ClearVü scanning sonar, you need a compatible transducer. For information about compatible transducers, go to garmin.com/transducers.

Garmin ClearVü high-frequency sonar provides a detailed picture of the fishing environment around the boat in a detailed representation of structures the boat is passing over.

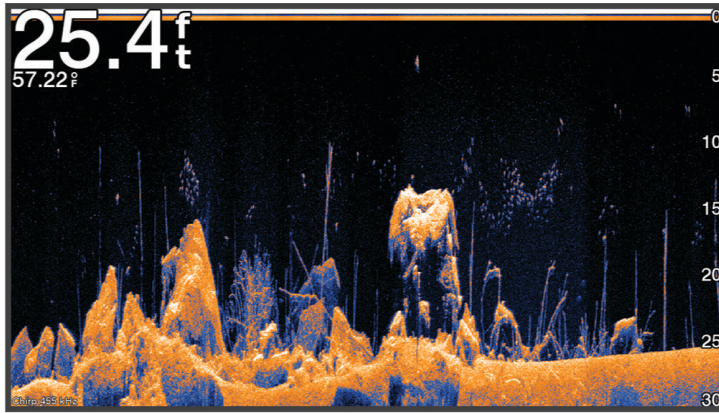

Traditional transducers emit a conical beam. The Garmin ClearVü scanning sonar technology emits a beam similar to the shape of the beam in a copy machine. This beam provides a clearer, picture-like image of what is beneath the boat.

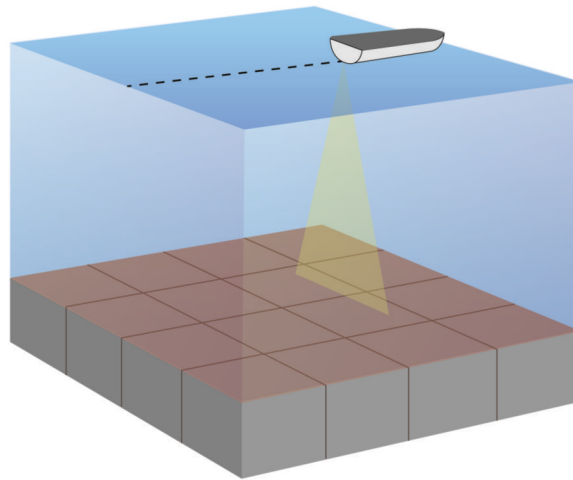

Garmin SideVü™ Sonar View

NOTE: Not all models provide built-in Garmin SideVü sonar support. If your model does not provide built-in SideVü sonar, you need a compatible sonar module and compatible SideVü transducer.

If your model does provide built-in SideVü sonar, you need a compatible SideVü transducer.

SideVü scanning sonar technology shows you a picture of what lies to the sides of the boat. You can use this as a search tool to find structures and fish.

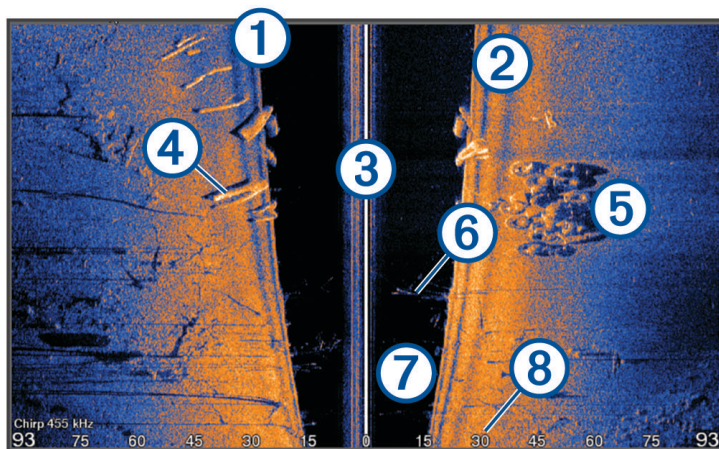

①	Port side of the boat
②	Starboard side of the boat
③	The transducer on your vessel
④	Logs
⑤	Old tires
⑥	Trees
⑦	Water between the vessel and the bottom
⑧	Distance from the side of the boat

SideVü Scanning Technology

Instead of a more common conical beam, the SideVü transducer uses a flat beam to scan the water and bottom to the sides of your boat.

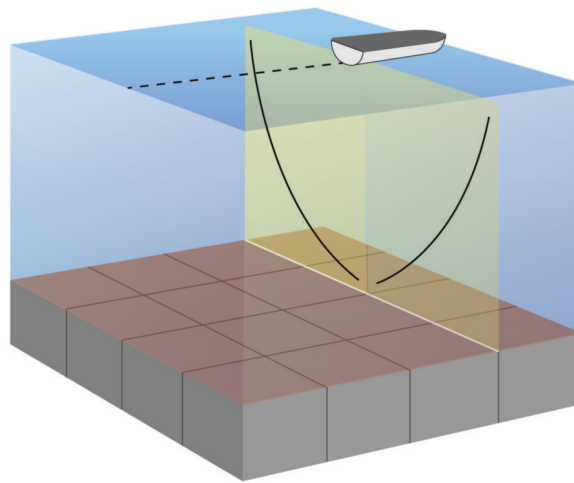

Measuring Distance on the Sonar Screen

You can measure the distance between two points on the SideVü sonar view.

- 1 From the SideVü sonar view, select **■**.
- 2 Select a location on the screen.
- 3 Select **Measure**.
A push pin appears on the screen at the selected location.
- 4 Select another location.
The distance and angle from the pin is listed in the upper-left corner.

TIP: To reset the pin and measure from the current location of the pin, select Set Reference.

Panoptix™ Sonar Views

To receive Panoptix sonar, you need a compatible transducer.

The Panoptix sonar views allow you to see all around the boat in real time. You can also watch your bait underwater and bait schools in front of or below your boat.

The LiveVü sonar views provide you a view of the live movement either in front of or below your boat. The screen updates very quickly, producing sonar views that look more like live video.

The RealVü 3D sonar views provide three-dimensional views of either what is in front of or below your boat. The screen updates with each sweep of the transducer.

To see all five Panoptix sonar views, you need one transducer to show the down views and a second transducer to show the forward views.

To access the Panoptix sonar views, select Sonar, and select a view.

LiveVü Down Sonar View

This sonar view shows a two-dimensional view of what is below the boat and can be used to see a bait ball and fish.

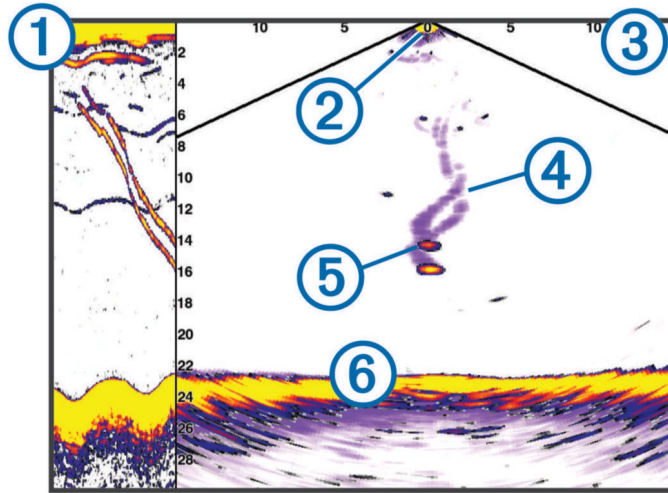

①	Panoptix down view history in a scrolling sonar view
②	Boat
③	Range
④	Trails
⑤	Drop shot rig
⑥	Bottom

LiveVü Forward Sonar View

This sonar view shows a two-dimensional view of what is in front of the boat and can be used to see a bait ball and fish.

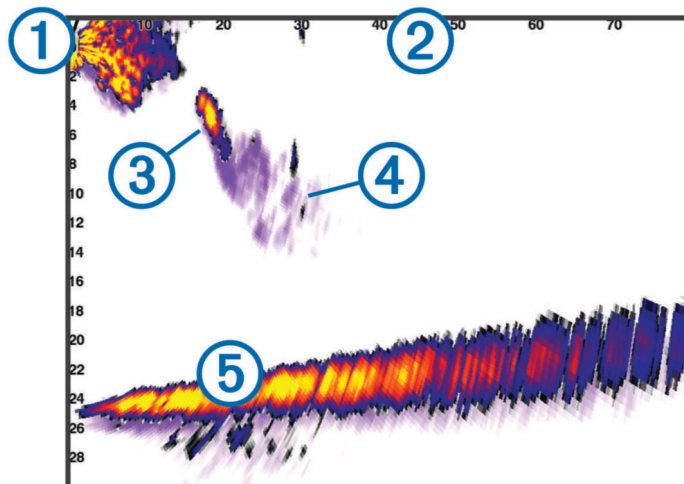

①	Boat
②	Range
③	Fish

④	Trails
⑤	Bottom

RealVü 3D Forward Sonar View

This sonar view shows a three-dimensional view of what is in front of the transducer. This view can be used when you are stationary and you need to see the bottom and the fish approaching the boat.

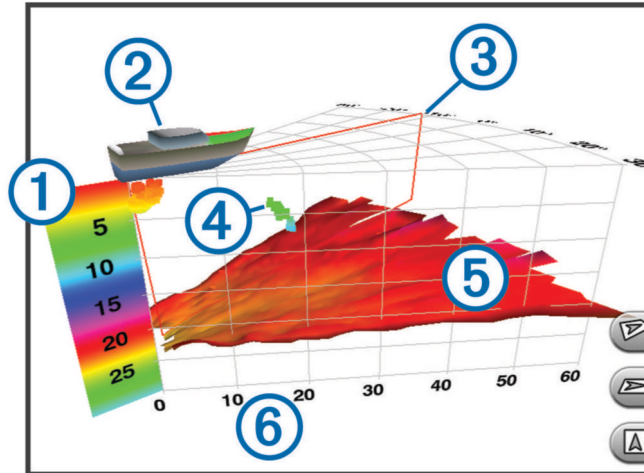

①	Color legend
②	Boat
③	Ping indicator
④	Fish
⑤	Bottom
⑥	Range

RealVü 3D Down Sonar View

This sonar view shows a three-dimensional view of what is below the transducer and can be used when you are stationary and want to see what is around your boat.

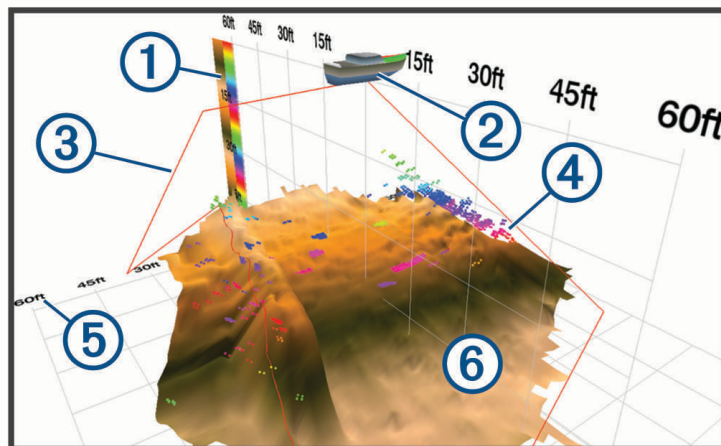

①	Color legend
②	Boat

③	Sonar beam
④	Range
⑤	Fish
⑥	Bottom

RealVü 3D Historical Sonar View

This sonar view provides a three-dimensional view of what is behind your boat as you are moving and shows the entire water column in 3D, from the bottom to the top of the water. This view is used for finding fish.

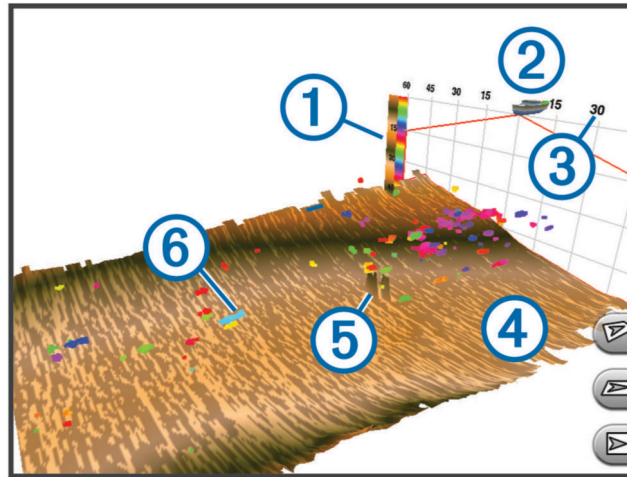

①	Color legend
②	Boat
③	Range
④	Bottom
⑤	Structure
⑥	Fish

LiveVü Layer

You can enable the LiveVü Layer view on the RealVü 3D Historical sonar view only when using a compatible transducer, such as a Panoptix™ PS70-TH.

The LiveVü Layer view adds the LiveVü down view to the RealVü 3D Historical sonar view.

To enable the LiveVü Layer view on the RealVü 3D Historical sonar view, select **••• > LiveVü Layer**.

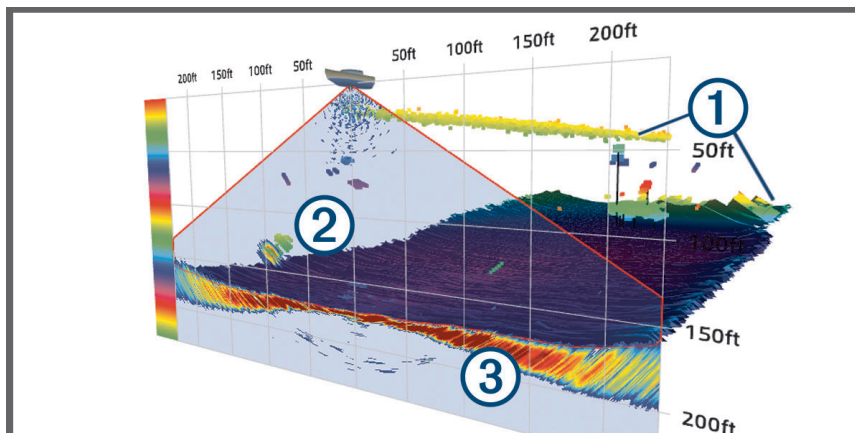

①	RealVü 3D Historical bottom, structure, and fish
②	LiveVü down view structure and fish
③	LiveVü down view bottom

True Motion

You can enable the True Motion feature on the RealVü 3D Historical sonar view only when using a compatible transducer, such as a Panoptix™ PS70-TH.

The True Motion feature on the RealVü 3D Historical sonar view uses data from additional sensors connected to the chartplotter, such as speed and heading sensors, to show a more geographically accurate historical view.

To enable the True Motion feature on the RealVü 3D Historical sonar view, select **••• > True Motion**.

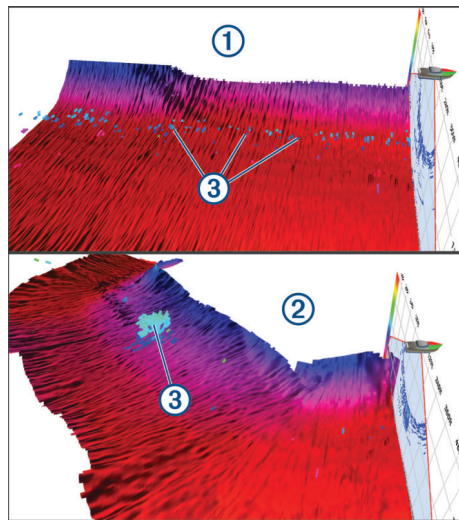

①	Standard RealVü 3D Historical view
②	RealVü 3D Historical view with the True Motion feature enabled
③	Fish

Garmin FrontVü™ Sonar View

The Panoptix Garmin FrontVü sonar view increases your situational awareness by showing obstructions under the water, up to 91 meters (300 feet) in front of the boat.

The ability to effectively avoid forward collisions with Garmin FrontVü sonar decreases as your speed rises above 8 knots.

To see the Garmin FrontVü sonar view, you must install and connect a compatible transducer, such as a PS21 transducer. You may need to update the transducer software.

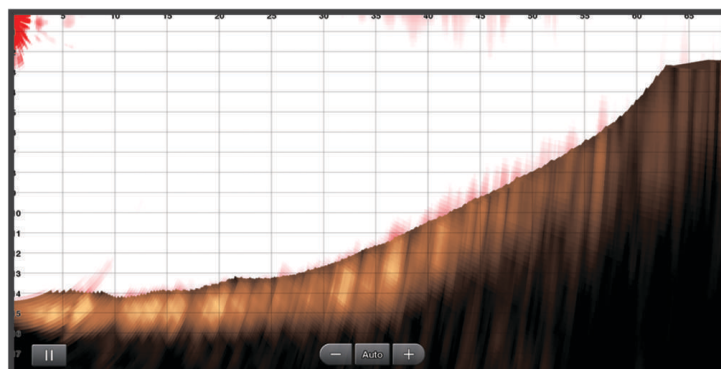

Triple Beam Sonar View

The Triple Beam sonar view is available only when using a compatible transducer, such as the Panoptix™ PS70-TH.

This sonar view shows three traditional sonar views on one screen, so you can simultaneously see separate sonar readings from the port side, the starboard side, and the center of the boat. You can add each separate view to combo pages as needed.

You can adjust the angle and width of the three sonar beams in the ⋮ menu. Other sonar options and settings, such as the sonar Gain, are synchronized across all three views.

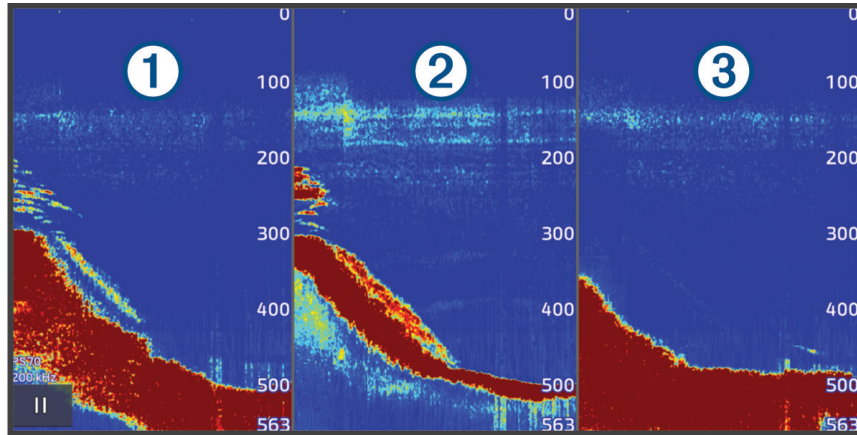

①	Port transducer beam
②	Center transducer beam
③	Starboard transducer beam

LiveScope™ Sonar View

This sonar view shows a live view of what is in front of or below the boat and can be used to see fish and structures.

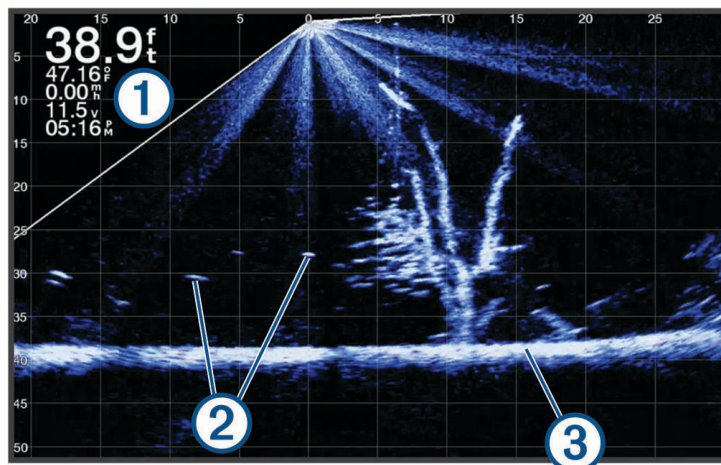

①	Depth information
②	Suspended targets or fish
③	Bottom of the body of water

Zooming in a Panoptix™ LiveVü or LiveScope™ Sonar View

You can zoom in on the Panoptix LiveVü and LiveScope 2D sonar views.

NOTE: The scrolling history is hidden while the screen is in zoom mode.

- 1 From a Panoptix LiveVü or LiveScope 2D sonar view, spread two fingers apart to zoom in on the area. An inset window ① appears and displays a small version of the full-screen image. The boxed area ② in the inset shows the location of the zoomed area.

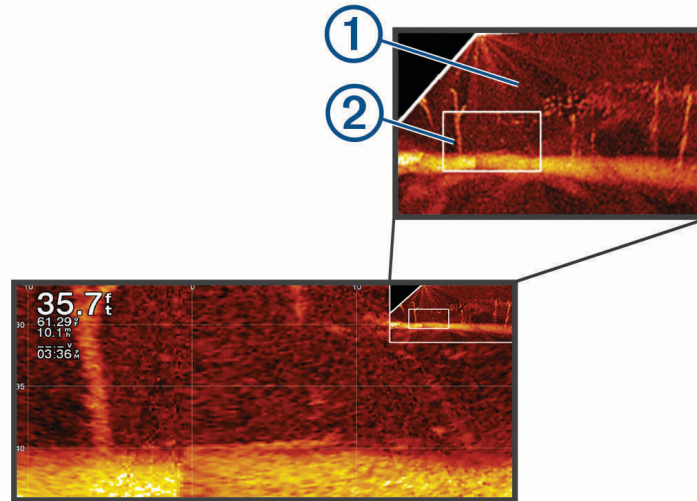

- 2 If necessary, tap or drag within the inset window to view a different area of the full-screen view.
 - 3 If necessary, spread two fingers apart to zoom in.
 - 4 If necessary, pinch two fingers together to zoom out.
- To exit zoom mode, select Back or pinch two fingers together to zoom out until the screen returns to a full-screen view.

Perspective View

This sonar view shows a live view of what is around and ahead of your boat and can be used to see shorelines, fish, and structures. This view is best used in shallow water of 50 feet (15 meters) or less.

To see this sonar view, you must install a compatible LiveScope transducer on compatible a perspective mode mount.

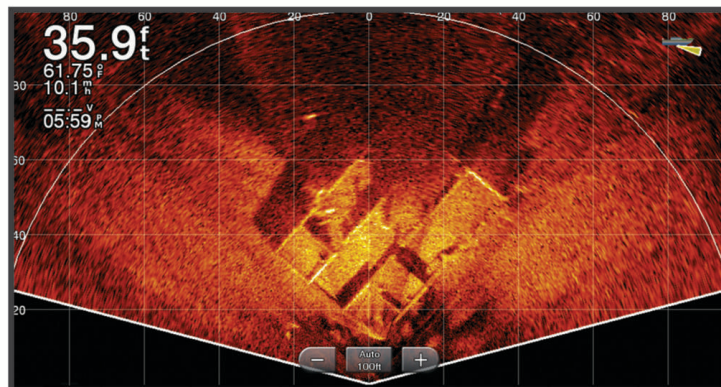

Flasher View

The flasher shows sonar information on a circular depth scale, indicating what is beneath your boat. It is organized as a ring that starts at the top and progresses clockwise. Depth is indicated by the scale inside the ring. Sonar information flashes on the ring when it is received at the depth indicated.

The flasher colors indicate different strengths of the sonar return. The default color scheme follows a traditional sonar color palette, in which yellow indicates the strongest return, orange indicates a strong return, red indicates a weaker return, and blue indicates the weakest return.

Select **Sonar > Flasher**.

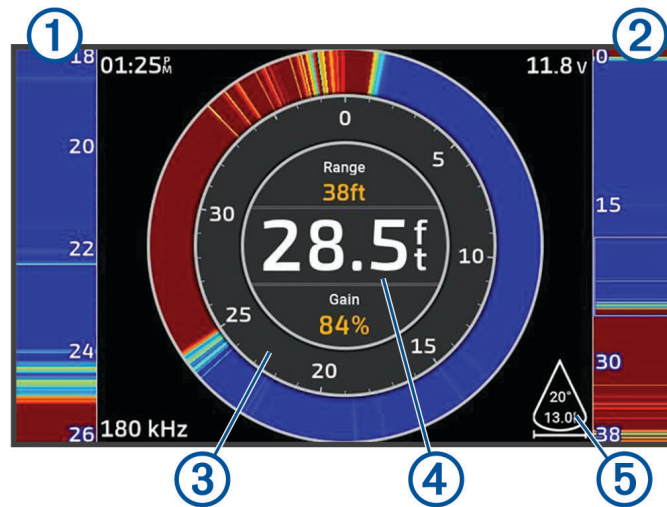

①	A-scope, zoomed-in view of the right side view
②	A-scope with zoom area outlined ¹
③	Depth scale
④	Depth at your present location
⑤	Angle and span of the transducer cone at the current frequency

Sonar Views in Combo Screens

You can add one or more available sonar views to a custom combination screen ([Creating a New Combination Page, page 17](#)). If more than one source of sonar data is available, you can show sonar screens using different sonar sources in separate windows of a custom combo screen.

If you have more than one source of sonar data available, you are prompted to select the source to use when creating a custom combo. After you create the combo, you can change the source used in a window of the combo screen later ([Selecting a Sonar Source, page 77](#)).

Selecting the Transducer Type

This chartplotter is compatible with a range of accessory transducers, including the Garmin ClearVü™ transducers, which are available at garmin.com/transducers.

If you are connecting a transducer that was not included with the chartplotter, you may need to set the transducer type to make the sonar function properly.

NOTE: Not all chartplotters and sonar modules support this feature.

1 Complete an action:

- From a sonar view, select **••• > Sonar Setup > Installation > Transducers**.
- Select **⚙ > My Vessel > Transducers**.

2 Select the transducer that you want to change, and select **Change Model**.

3 Select an option:

- To enable the chartplotter to detect the transducer automatically, select **Auto Detect**.
- To select the transducer manually, select the option that matches the installed transducer, such as **Dual Beam (200/77 kHz)** or **Dual Freq (200/50 kHz)**.

NOTICE

Manually selecting a transducer could result in damage to the transducer or reduced transducer performance.

NOTE: If you select the transducer manually, disconnect that transducer, and then connect a different transducer, you should reset this option to **Auto Detect**.

¹ You can drag the outline to move the zoom area up and down.

Selecting a Sonar Source

When you have more than one transducer providing data for a particular sonar view, you can select the source to use for that sonar view. For example, if you have two transducers providing Garmin ClearVü™ data, you can select the source to use for the Garmin ClearVü sonar view.

- 1 Open the sonar view for which you will change the source.
If the sonar view is in a combo screen, you must select the view you want to change.
- 2 Select **••• > Sonar Setup > Source**.
- 3 Select the source for this sonar view.

Renaming a Sonar Source

You can rename a sonar source to easily identify that source. A sonar source is associated with the chartplotter or sounder module with a connected transducer. For example, you can use "Bow" as the name of the chartplotter installed on the bow of your boat with a connected transducer.

- 1 Select **⚙ > Communications > BlueNet™ Network**.
- 2 Select the chartplotter or sounder module you want to rename.
- 3 Select **Change Name**.
- 4 Enter the name.

Pausing and Resuming the Sonar Display

NOTE: Pausing the sonar display affects only the sonar view on the device where you pause the sonar display. The transducer continues to transmit and receive sonar signals, and other connected displays continue to show live sonar data.

From a sonar view, select an option:

- Select **⏸**.
- Swipe or drag the screen in the direction of the scrolling sonar.

To resume sonar scrolling after pausing, select **▶**.

If you pause a full-screen sonar view that is part of a combo, you can select Back to return to the combo screen while the sonar remains paused.

Paused Sonar Considerations

When you pause the sonar display, the system continues to gather sonar information in the background. When you resume sonar scrolling, the sonar data gathered while scrolling was paused is refreshed on the sonar display with a line indicating the point where you paused it.

In most cases, all of the sonar data gathered while it was paused is shown on the screen immediately after you resume scrolling. The location on the graph where you paused scrolling is indicated by a dashed line.

Factors such as the number of sonar windows being viewed, the speed and range of the sonar transmissions, and the capabilities of your chartplotter may reduce the amount of sonar data saved, depending on how long the scrolling was paused. When scrolling is paused longer than the device is able to retain the data, the last recorded point is indicated by a solid line on the graph.

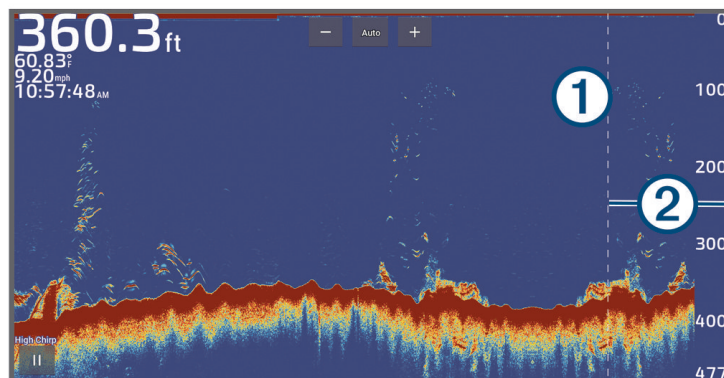

①	<p>Line indicating when the sonar scrolling was paused:</p> <ul style="list-style-type: none"> • Dashed line: the sonar was paused here, and everything to the right of the line was continuously recorded while paused. This line fades after a few seconds upon resuming scrolling, and is not preserved in the sonar history. • Solid line: not all sonar data was continuously recorded due to your system configuration and the duration of the pause. This indicates a break in sonar recording and only data to the right of the line was retained. This line does not fade, and it is preserved in the sonar history.
②	Sonar data gathered while paused.

Viewing Sonar History

You can scroll the sonar display to view historical sonar data.

NOTE: Not all transducers save historical sonar data.

- 1 From a sonar view, pause the sonar display (*Pausing and Resuming the Sonar Display, page 77*).
- 2 Swipe or drag the screen in the direction of the scrolling sonar to view the history.
- 3 Select ► to exit history and resume sonar scrolling.

Creating a Waypoint on the Sonar Screen

- 1 From a sonar view, pause the sonar display (*Pausing and Resuming the Sonar Display, page 77*).
- 2 If necessary, scroll through the sonar display history until you find the location where you want to create a waypoint.
- 3 Select a location on the sonar view where you want to create the waypoint.
- 4 Select 📍.
- 5 If necessary, edit the waypoint information.

Adjusting the Level of Detail

You can control the level of detail and noise shown on the sonar screen either by adjusting the gain for traditional transducers or by adjusting the brightness for Garmin ClearVü™ transducers.

If you want to see the highest intensity signal returns on the screen, you can lower the gain or brightness to remove lower intensity returns and noise. If you want to see all return information, you can increase the gain or brightness to see more information on the screen. This also increases noise, and can make it more difficult to recognize actual returns.

- 1 From a sonar view, select ⋮.
- 2 Select **Gain** or **Brightness**.
- 3 Select an option:
 - To increase or decrease the gain or brightness manually, select **Up** or **Down**.
 - To allow the chartplotter to adjust the gain or brightness automatically, select an automatic option.

Adjusting the Color Intensity

You can adjust the intensity of colors and highlight areas of interest on the sonar screen by adjusting the color gain for traditional transducers or the contrast for some transducers. This setting works best after you have adjusted the level of detail shown on the screen using the gain or brightness settings.

If you want to highlight smaller fish targets or create a higher intensity display of a target, you can increase the color gain or contrast setting. This causes a loss in the differentiation of the high intensity returns at the bottom. If you want to reduce the intensity of the return, you can reduce the color gain or contrast.

- 1 From a sonar view, select ⋮.
- 2 Select an option based on sonar view:
 - Select **Contrast**.
 - Select **Sonar Setup > Appearance > Color Gain**.
- 3 Select an option:
 - To increase or decrease the color intensity manually, select **Up** or **Down**.
 - To use the default setting, select **Default**.

Sonar Setup

NOTE: Not all options and settings apply to all models and transducers.

These settings apply to the following types of transducers.

- Traditional
- Garmin ClearVü™
- SideVü

These settings do not apply to Panoptix™ transducers.

From a sonar view, select **☰ > Sonar Setup**.

Scroll Speed: Sets the rate at which the sonar scrolls from right to left ([Setting the Scroll Speed, page 79](#)).

In shallow water, you can select a slower scroll speed to extend the length of time the information is displayed on screen. In deeper water, you can select a faster scroll speed. Automatic scroll speed adjusts the scrolling speed to the speed the boat is traveling.

Noise Reject: Reduces the interference and the amount of clutter shown on the sonar screen ([Sonar Noise Rejection Settings, page 80](#)).

Appearance: Configures the appearance of the sonar screen ([Sonar Appearance Settings, page 80](#)).

Alarms: Sets sonar alarms ([Sonar Alarms, page 81](#)).

Advanced: Configures various sonar display and data source settings ([Advanced Sonar Settings, page 81](#)).

Installation: Configures the transducer ([Transducer Installation Settings, page 81](#)).

Setting the Zoom Level on the Sonar Screen

1 From a sonar view, select **☰ > Zoom > ☰ > Mode**.

2 Select an option:

- To set the depth and zoom automatically, select **Auto**.
If necessary, select **Set Zoom** to modify the zoom setting. Select **View Up** or **View Down** to set the depth range of the magnified area, and select **Zoom In** or **Zoom Out** to increase or decrease the magnification of the magnified area.
- To set the depth range of the magnified area manually, select **Manual**.
If necessary, select **Set Zoom** to modify the zoom setting. Select **View Up** or **View Down** to set the depth range of the magnified area, and select **Zoom In** or **Zoom Out** to increase or decrease the magnification of the magnified area.
- To magnify one particular area of the screen, select **Magnify**.
If necessary, select **Magnify** to increase or decrease the magnification level.
TIP: You can drag the magnification box to a new location on the screen.
- To zoom in on the sonar data from the bottom depth, select **Bottom Lock**.
If necessary, select **Span** to adjust the depth and placement of the bottom lock area.

To cancel the zoom, deselect the Zoom option.

Enabling a Split Zoom Sonar View

When the zoom is set to Auto, Manual, or Bottom Lock, you can enable a split zoom view to show both the standard view and the zoomed-in view side-by-side.

From a sonar view, select **☰ > Zoom > ☰ > Split Zoom**.

To disable the split zoom view, select Split Zoom again.

Setting the Scroll Speed

You can set the rate at which the sonar image moves across the screen. A higher scroll speed shows more detail until there is no additional detail to show, at which point it starts stretching out the existing detail. This can be useful while moving or trolling, or when you are in very deep water where the sonar is pinging very slowly. A lower scroll speed displays sonar information on the screen longer.

For most situations, the Default setting provides a good balance between a quickly scrolling image and less distorted targets.

1 From a sonar view, select **☰ > Sonar Setup > Scroll Speed**.

2 Select an option:

- To adjust the scroll speed automatically using speed-over-ground or water speed data, select **Auto**.
The **Auto** setting selects a scroll rate to match the boat speed, so targets in the water are drawn with the correct aspect ratio and appear less distorted. When viewing Garmin ClearVü™/SideVü sonar views or searching for structure, it is recommend to use the **Auto** setting.
- To scroll faster, select **Up**.
- To scroll more slowly, select **Down**.

Adjusting the Range

You can adjust the range of the depth scale for traditional and Garmin ClearVü™ sonar views. You can adjust the range of the width scale for the SideVü sonar view.

Allowing the device to adjust the range automatically keeps the bottom within the lower or outer third of the sonar screen, and can be useful for tracking a bottom that has minimal or moderate terrain changes.

Manually adjusting the range enables you to view a specified range, which can be useful for tracking a bottom that has large terrain changes, such as a drop-offs or cliffs. The bottom can appear on the screen as long as it appears within the range you have set.

- 1 From a sonar view, select **••• > Range**.
- 2 Select an option:
 - To allow the chartplotter to adjust the range automatically, select **Auto**.
 - To increase or decrease the range manually, select **Up** or **Down**.

TIP: From the sonar screen, you can select **+** or **-** to manually adjust the range.

TIP: When viewing multiple sonar screens, you can select **Select** to choose the active screen.

Sonar Noise Rejection Settings

From a sonar view, select **••• > Sonar Setup > Noise Reject**.

Interference: Adjusts the sensitivity to reduce the effects of interference from nearby sources of noise.

The lowest interference setting that achieves the desired improvement should be used to remove interference from the screen. Correcting installation issues that cause noise is the best way to eliminate interference.

Color Limit: Hides part of the color palette to help eliminate fields of weak clutter.

By setting the color limit to the color of the undesired returns, you can eliminate the display of undesired returns on the screen.

Smoothing: Removes noise that is not part of a normal sonar return, and adjusts the appearance of returns, such as the bottom.

When smoothing is set to high, more of the low-level noise remains than when using the interference control, but the noise is more subdued because of averaging. Smoothing can remove speckle from the bottom.

Smoothing and interference work well together to eliminate low-level noise. You can adjust the interference and smoothing settings incrementally to remove undesirable noise from the display.

Surface Noise: Hides surface noise to help reduce clutter. Wider beam widths (lower frequencies) can show more targets, but can generate more surface noise.

TVG: Adjusts the time varying gain, which can reduce noise.

This control is best used for situations when you want to control and suppress clutter or noise near the water surface. It also allows for the display of targets near the surface that are otherwise hidden or masked by surface noise.

Sonar Appearance Settings

From a sonar view, select **••• > Sonar Setup > Appearance**.

Color Scheme: Sets the color scheme.

Color Gain: Adjusts the intensity of colors (*Adjusting the Color Intensity*, page 78).





A-Scope: Displays a vertical flasher along the right side of the screen that shows instantaneously the range to targets along a scale.

Depth Line: Shows a quick-reference depth line.

Edge: Highlights the strongest signal from the bottom to help define the hardness or softness of the signal.

View Selection: Sets the direction of the Garmin SideVü™ sonar view.

Fish Symbols: Sets how the sonar interprets suspended targets.

	Shows suspended targets as symbols and background sonar information.
	Shows suspended targets as symbols with target depth information and background sonar information.
	Shows suspended targets as symbols.
	Shows suspended targets as symbols with target depth information.

Pic. Advance: Allows the sonar picture to advance faster by drawing more than one column of data on the screen for each column of sonar data received. This is especially helpful when you are using the sonar in deep water, because the sonar signal takes longer to travel to the water bottom and back to the transducer. The 1/1 setting draws one column of information on the screen per sonar return. The 2/1 setting draws two columns of information on the screen per sonar return, and so on for the 4/1 and 8/1 settings.

Overlay Data: Sets the data shown on the sonar screen.

Sonar Alarms

WARNING

The sonar alarms feature is a tool for situational awareness only and may not prevent grounding in all circumstances. It is your obligation to ensure safe operation of the vessel.

CAUTION

The Beeper setting must be turned on to make alarms audible (*Sounds and Display Settings, page 152*). Failure to set audible alarms could lead to injury or property damage.

NOTE: Not all options are available on all transducers.

From an applicable sonar view, select **☰ > Sonar Setup > Alarms**.

You can also open the sonar alarms by selecting **⚙ > Alarms > Sonar**.

Shallow Water: Sets an alarm to sound when the depth is less than the specified value.



Deep Water: Sets an alarm to sound when the depth is greater than the specified value.

FrontVü Alarm: Sets an alarm to sound when the depth in front of the vessel is less than the specified value, which can help you avoid running aground (*Setting the Garmin FrontVü™ Depth Alarm, page 84*). This alarm is available only with Panoptix™ Garmin FrontVü™ transducers.

Water Temp.: Sets an alarm to sound when the transducer reports a temperature that is 2°F (1.1°C) above or below the specified temperature.

Contour: Sets an alarm to sound when the transducer reports a water depth below a specified shallow limit or above a specified deep limit. This helps by calling attention when encountering a steep drop-off or a sudden shallow area.

Fish: Sets an alarm to sound when the device detects a suspended target.

-  sets the alarm to sound when fish of all sizes are detected.
-  sets the alarm to sound only when medium or large fish are detected.
-  sets the alarm to sound only when large fish are detected.

Advanced Sonar Settings

From a Traditional sonar view, select **☰ > Sonar Setup > Advanced**.

Btm. Srch. Limit: Limits the search for the bottom to the depth selected when the Range setting is set to Auto. To minimize the length of time it takes to find the bottom, you can select a depth to limit the search for the bottom. The device will not search for the bottom deeper than the selected depth.

Range Sync > Off: The range for all sonar views in a combo screen are independent of one another.

Range Sync > On: This setting option is available only when viewing a combo screen using at least two traditional and Garmin ClearVü™ views in a combo screen. The range is synchronized for all traditional and Garmin ClearVü views in the combo screen.

Range Sync > Same Transducer Only: This is the default setting. The ranges are synchronized for views from each transducer in the combo screen, but not between different transducers.

NOTE: This setting does not apply to a dual-band CHIRP transducer.

Scroll Sync: This setting option is available only when viewing a combo screen using at least two traditional and Garmin ClearVü sonar views in a combo screen. The scroll rates are synchronized for all traditional and Garmin ClearVü views in the combo screen.

Transducer Installation Settings

These settings apply to the following types of sonar.

- Traditional
- Garmin ClearVü™
- Garmin SideVü™

From an applicable sonar view, select an option.

- From a Traditional sonar view, select **☰ > Sonar Setup > Installation**.

- From a Garmin ClearVü sonar view, select **••• > ClearVü Setup > Installation**.
- From a Garmin SideVü sonar view, select **••• > SideVü Setup > Installation**.

Flip Left/Right: Switches the SideVü view orientation from left to right. This option is available on the SideVü sonar view only.

Restore Sonar Defaults: Restores the sonar settings to the factory default values.

Transducers: View details about installed transducers and save details to a memory card.

Transducers > Change Model: Allows you to change an installed transducer type ([Selecting the Transducer Type, page 76](#)).

Transducers > Manual Configuration: Allows you to set manual transducer configuration parameters on a compatible sonar module. See the installation instructions for your compatible sonar module for more details on connecting and manually configuring a transducer.

Sonar Frequencies

The frequencies available depend on the transducers being used.

Adjusting the frequency helps adapt the sonar for your particular goals and the present depth of the water.

Higher frequencies use narrow beam widths, and are better for high-speed operation and rough sea conditions. Bottom definition and thermocline definition can be better when using a higher frequency.

Lower frequencies use wider beam widths, which can let the fisherman see more targets, but could also generate more surface noise and reduce bottom signal continuity during rough sea conditions. Wider beam widths generate larger arches for fish target returns, making them ideal for locating fish. Wider beam widths also perform better in deep water, because the lower frequency has better deep water penetration.

CHIRP frequencies allow you to sweep each pulse through a range of frequencies, resulting in better target separation in deep water. CHIRP can be used to distinctly identify targets, like individual fish in a school, and for deep water applications. CHIRP generally performs better than single frequency applications. Because some fish targets may show up better using a fixed frequency, you should consider your goals and water conditions when using CHIRP frequencies.

Some transducers also provide the ability to customize preset frequencies for each transducer element, which enables you to change the frequency quickly using the presets as the water and your goals change.

Viewing two frequencies concurrently using the split-frequency view allows you to see deeper with the lower frequency return and, at the same time, see more detail from the higher frequency return.

NOTICE

Always be aware of local regulations on sonar frequencies. For example, to protect orca whale pods, you might be prohibited from using frequencies between 50 to 80 kHz within $\frac{1}{2}$ mile of an orca whale pod. It is your responsibility to use the device in compliance with all applicable laws and ordinances.

Selecting the Transducer Frequency

You cannot adjust the frequency for all sonar views and transducers.

You can select which frequencies appear on the sonar screen.

NOTICE

Always be aware of local regulations on sonar frequencies. For example, to protect orca whale pods, you might be prohibited from using frequencies between 50 to 80 kHz within $\frac{1}{2}$ mile of an orca whale pod. It is your responsibility to use the device in compliance with all applicable laws and ordinances.

- 1 From a sonar view, select **••• > Frequency**.
- 2 Select a frequency suited to your needs and water depth.
For more information on frequencies, see [Sonar Frequencies, page 82](#).

Creating a Frequency Preset

Not available with all transducers.

You can create a preset to save a specific sonar frequency, which allows you to change frequencies quickly.

- 1 From a sonar view, select **••• > Frequency**.
- 2 Select **Manage Frequencies > New Preset**.
- 3 Enter a frequency.

Turning On the A-Scope

NOTE: This feature is available in the Traditional sonar views.

The a-scope is a vertical flasher along the right side of the view, showing you what is underneath the transducer right now. You can use the a-scope to identify target returns that may be missed when the sonar data is quickly scrolling across the screen, such as when your boat is moving at high speeds. It can also be helpful for detecting fish that are close to the bottom.

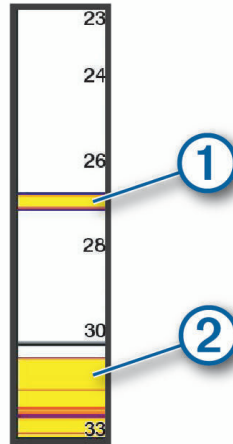

The a-scope above shows fish returns ① and a soft bottom return ②.



- 1 From a sonar view, select **☰ > Sonar Setup > Appearance > A-Scope**.
- 2 If necessary, select **☰ > Peak Hold** to adjust the length of time the sonar returns are displayed.

Panoptix™ Sonar Setup

Adjusting the RealVü Viewing Angle and Zoom Level

You can change the viewing angle of the RealVü sonar views. You can also zoom in and out of the view.

From a RealVü sonar view, select an option:

- To adjust the viewing angle diagonally, select .
- To adjust the viewing angle horizontally, select .
- To adjust the viewing angle vertically, select .
- To adjust the viewing angle, swipe the screen in any direction.
- To zoom in, spread two fingers apart.
- To zoom out, pinch two fingers together.

Adjusting the RealVü Sweep Speed

You can update how quickly the transducer sweeps back and forth. A faster sweep rate creates a less detailed image, but the screen refreshes faster. A slower sweep rate creates a more detailed image, but the screen refreshes more slowly.

This feature is not available for the RealVü 3D Historical sonar view.

- 1 From a RealVü sonar view, select **☰ > Sweep Speed**.
- 2 Select an option.

LiveVü Forward and Garmin FrontVü™ Sonar Settings

From the LiveVü Forward or Garmin FrontVü sonar view, select **☰**.

Gain: Controls the level of detail and noise shown on the sonar screen.

If you want to see the highest intensity signal returns on the screen, you can lower the gain to remove lower intensity returns and noise. If you want to see all return information, you can increase the gain to see more information on the screen. This also increases noise, and can make it more difficult to recognize actual returns.

Depth Range: Adjusts the range of the depth scale.

Allowing the device to adjust the range automatically keeps the bottom within the lower portion of the sonar screen, and can be useful for tracking a bottom that has minimal or moderate terrain changes.

Manually adjusting the range enables you to view a specified range, which can be useful for tracking a bottom that has large terrain changes, such as a drop-offs or cliffs. The bottom can appear on the screen as long as it appears within the range you have set.

Forward Range: Adjusts the range of the forward scale.

Allowing the device to adjust the range automatically adjusts the forward scale in relation to the depth. Manually adjusting the range enables you to view a specified range. The bottom can appear on the screen as long as it appears within the range you have set. Manually reducing this option can reduce the effectiveness of the FrontVü Alarm, reducing your reaction time to low depth readings.

Transmit Angle: Adjusts the focus of the transducer to the port or starboard side. This feature is available only with RealVü capable Panoptix transducers, such as the PS31 transducer.

Transmit: Stops the active transducer from transmitting.

FrontVü Alarm: Sets an alarm to sound when the depth in front of the vessel is less than the specified value (*Setting the Garmin FrontVü™ Depth Alarm, page 84*). This is available only with Panoptix Garmin FrontVü transducers.

Sonar Setup: Adjusts the setup of the transducer and the appearance of the sonar returns.

Edit Overlays: Adjusts the data shown on the screen (*Customizing the Data Overlays, page 18*).

Setting the LiveVü and Garmin FrontVü™ Transducer Transmit Angle

This feature is available only with RealVü capable Panoptix transducers, such as the PS30, PS31, and PS60.

You can change the transducer transmit angle to aim the transducer at a particular area of interest. For example, you might aim the transducer to follow a bait ball or focus on a tree as you pass it.

- 1 From a LiveVü or Garmin FrontVü sonar view, select **••• > Transmit Angle**.
- 2 Select an option.

Setting the Garmin FrontVü™ Depth Alarm

WARNING

Garmin FrontVü sonar and the Garmin FrontVü depth alarm are tools for situational awareness only, and may not prevent groundings in all circumstances. As vessel speeds approach and exceed 8 knots, your ability to effectively respond to the information provided by the sonar and/or alarm decreases. It is your responsibility to remain aware of your surroundings while underway and to operate your vessel in a safe and prudent manner. Failure to do so could result in an accident leading to property damage, personal injury, or death.

CAUTION

The Beeper setting must be turned on to make alarms audible (*Sounds and Display Settings, page 152*). Failure to set audible alarms could lead to injury or property damage.

NOTE: This alarm is available only with Panoptix™ Garmin FrontVü transducers.

You can set an alarm to sound when the depth is below a specified level. For best results, you should set the bow offset when using the front collision alarm (*Setting the Bow Offset, page 85*).

- 1 From the Garmin FrontVü sonar view, select **••• > FrontVü Alarm**.
- 2 Select **On**.
- 3 Enter the depth at which the alarm is triggered, and select **Done**.

On the Garmin FrontVü screen, a depth line shows the depth at which the alarm is set. The line is green when you are in a safe depth. The line turns yellow when you are going faster than the forward range gives you time to react (10 seconds). It turns red and sounds an alarm when the system detects an obstruction or the depth is less than the entered value.

LiveVü and Garmin FrontVü™ Appearance Settings

From a LiveVü or Garmin FrontVü Panoptix sonar view, select **••• > Sonar Setup > Appearance**.

Color Scheme: Sets the color palette.

Color Gain: Adjusts the intensity of colors shown on the screen.

You can select a higher color gain value to see targets higher in the water column. A higher color gain value also allow you to differentiate low intensity returns higher in the water column, but this causes a loss in the differentiation of the returns at the bottom. You can select a lower color gain value when targets are near the bottom, to help you distinguish between targets and high intensity returns such as sand, rock, and mud.

Trails: Sets the how long the trails appear on the screen. The trails show the movement of the target.

Bottom Fill: Colors the bottom brown to distinguish it from the water returns.

LiveVü and Garmin FrontVü™ Layout Settings

From a LiveVü or Garmin FrontVü Panoptix sonar view, select **••• > Sonar Setup > Layout**.

Grid Overlay: Shows a grid of range lines.

Scroll History: Shows the sonar history on the side of the screen.

Beam Icon: Selects the icon used to show the direction of the transducer beam.

On-screen Control: Shows the on-screen buttons.

Compress Range: In forward views, compresses the forward range farther away from the boat and expands the range closer to the boat. This allows you to see closer objects more clearly while keeping farther objects on the screen.

RealVü Appearance Settings

From a RealVü sonar view, select **☰ > Sonar Setup > Appearance**.

Point Colors: Sets a different color palette for the sonar return points.

Bottom Colors: Sets the color scheme for the bottom.

Bottom Style: Sets the style for the bottom. When you are in deep water, you can select the Points option and manually set the range to a shallower value.

Color Key: Shows a legend of the depths the colors represent.

On-screen Control: Shows or hides the on-screen buttons.

Panoptix™ Transducer Installation Settings

From a Panoptix sonar view, select **☰ > Sonar Setup > Installation**.

Install Depth: Sets the depth below the water line where the Panoptix transducer is mounted. Entering the actual depth at which the transducer is mounted results in a more accurate visual presentation of what is in the water.

Bow Offset: Sets the distance between the bow and the forward view Panoptix transducer installation location. This allows you to view the forward distance from the bow instead of the transducer location.

This applies to Panoptix transducers in the Garmin FrontVü™, LiveVü Forward, and RealVü 3D Forward sonar views.

Beam Width: Sets the width of the down view Panoptix transducer beam. Narrow beam widths allow you to see deeper and farther. Wider beam widths allow you to see more coverage area.

This applies to Panoptix transducers in the Garmin FrontVü, LiveVü Down, and LiveVü Forward sonar views.

Stabilization > Auto Stabilize: Enables the internal attitude heading sensors to detect the installation angle of the Panoptix transducer automatically. When this setting is turned on, you cannot manually specify the installation angle for the transducer.

Stabilization > Pitch Angle: Available only when Auto Stabilize is turned off. Allows you to enter the specific installation angle for the transducer. Many forward view transducers are installed at a 45-degree angle and down view transducers are installed at a zero-degree angle.

Stabilization > Flipped: Sets the orientation of the Panoptix sonar view when the down view transducer is installed with the cables pointing toward the port side of the boat.

This applies to Panoptix transducers in the LiveVü Down, RealVü 3D Down, and RealVü 3D Historical sonar views.

Calibrate Compass: Calibrates the internal compass in the Panoptix transducer ([Calibrating the Compass, page 86](#)).

This applies to Panoptix transducers with an internal compass, such as the PS21-TR transducer.

Orientation: Controls if the transducer is in down or forward installation mode. The Auto setting uses the AHRS sensor to determine the orientation.

This applies to PS22 transducers.

Restore Sonar Defaults: Restores the sonar settings to the factory default values.

Setting the Bow Offset

For forward view Panoptix™ transducers, you can enter a bow offset to compensate the forward distance readings for the transducer installation location. This allows you to view the forward distance from the bow instead of the transducer installation location.

This feature applies to Panoptix transducers in the Garmin FrontVü™, LiveVü Forward, and RealVü 3D Forward sonar views.

1 Measure the horizontal distance ① from the transducer to the bow.

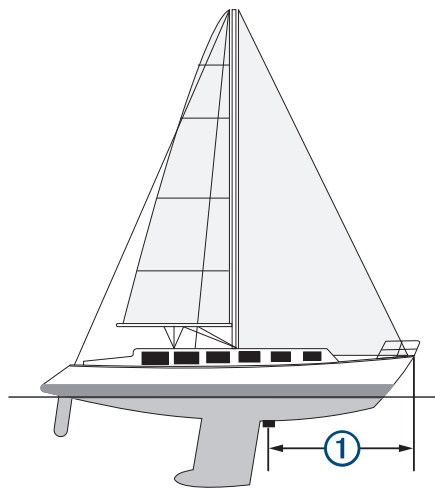

2 From an applicable sonar view, select **☰ > Sonar Setup > Installation > Bow Offset**.

3 Enter the distance measured, and select **Done**.

On the applicable sonar view, the forward range shifts by the distance you entered.

Calibrating the Compass

Before you can calibrate the compass, the transducer must be installed far enough away from the trolling motor to avoid magnetic interference, and deployed in the water. Calibration must be of sufficient quality to enable the internal compass.

NOTE: The compass may not work if you mount the transducer on the motor.

NOTE: For best results, you should use a heading sensor such as the SteadyCast™ heading sensor. The heading sensor shows the direction the transducer is pointing relative to the boat.

NOTE: Compass calibration is available only for transducers with an internal compass, such as the PS21-TR transducer.

You can begin turning your boat before calibrating, but you must fully rotate your boat 1.5 times during calibration.

1 From an applicable sonar view, select **☰ > Sonar Setup > Installation**.

2 If necessary, select **Use AHRS** to turn on the AHRS sensor.

3 Select **Calibrate Compass**.

4 Follow the on-screen instructions.

LiveScope and Perspective Sonar Settings

From the LiveScope or Perspective sonar view, select **☰**.

Gain: Controls the level of detail and noise shown on the sonar screen.

If you want to see the highest intensity signal returns on the screen, you can lower the gain to remove lower intensity returns and noise. If you want to see all return information, you can increase the gain to see more information on the screen. Increasing the gain also increases noise, and can make it more difficult to recognize actual returns.

Depth Range: Adjusts the range of the depth scale.

Allowing the device to adjust the range automatically keeps the bottom within the lower portion of the sonar screen, and can be useful for tracking a bottom that has minimal or moderate terrain changes.

Manually adjusting the range enables you to view a specified range, which can be useful for tracking a bottom that has large terrain changes, such as a drop-offs or cliffs. The bottom can appear on the screen as long as it appears within the range you have set.

Available in LiveScope sonar view.

Forward Range: Adjusts the range of the forward scale.

Allowing the device to adjust the range automatically adjusts the forward scale in relation to the depth.

Manually adjusting the range enables you to view a specified range. The bottom can appear on the screen as long as it appears within the range you have set.

Available in LiveScope sonar view.

Range: Adjusts the range.

Allowing the device to adjust the range automatically keeps the bottom within the lower or outer third of the sonar screen, and can be useful for tracking a bottom that has minimal or moderate terrain changes.

Manually adjusting the range enables you to view a specified range, which can be useful for tracking a bottom that has large terrain changes, such as a drop-offs or cliffs. The bottom can appear on the screen as long as it appears within the range you have set.

Available in Perspective sonar view.

Transmit: Stops the active transducer from transmitting.

Sonar Setup: Adjusts the setup of the transducer and the appearance of the sonar returns (*LiveScope and Perspective Sonar Setup, page 87*).

Edit Overlays: Adjusts the data shown on the screen (*Customizing the Data Overlays, page 18*).

LiveScope and Perspective Sonar Setup

From the LiveScope or Perspective sonar view, select **☰ > Sonar Setup**.

Appearance: Configures the appearance of the sonar screen (*LiveScope and Perspective Appearance Settings, page 87*).

Layout: Configures the layout of the sonar screen (*LiveScope and Perspective Layout Settings, page 87*).

Noise Reject: Reduces noise and interference and attempts to remove returns that are not actually targets in the water.

Ghost Reject: Reduces the occurrence of "ghost" images, which are duplicated or reflected images that are not actually targets in the water. The Ghost Reject setting sends more transmit power forward in the water to see farther with less noise generated by the bottom. Adjusting the Ghost Reject and Noise Reject settings together reduces the occurrence of "ghost" images most effectively. This feature is available in LiveScope Forward orientation only.

TVG: Adjusts the time varying gain, which can reduce noise.

This control is best used for situations when you want to control and suppress clutter or noise near the water surface. It also allows for the display of targets near the surface that are otherwise hidden or masked by surface noise.

Overlay Data: Sets the data shown on the sonar screen.

Installation: Configures the transducer (*LiveScope and Perspective Transducer Installation Settings, page 87*).

LiveScope and Perspective Appearance Settings

From the LiveScope or Perspective sonar view, select **☰ > Sonar Setup > Appearance**.

Color Scheme: Sets the color palette.

Color Gain: Adjusts the contrast of colors shown on the screen.

You can select a higher color gain value to see minor variances in targets with large color changes. You can select a lower color gain value to see more similar colors in the same situation.

Trails: Sets the how long the trails appear on the screen. The trails show the movement of the target.

Bottom Fill: Colors the bottom brown to distinguish it from the water returns. Not available in Perspective mode.

LiveScope and Perspective Layout Settings

From the LiveScope or Perspective sonar view, select **☰ > Sonar Setup > Layout**.

Grid Overlay: Shows a grid of range lines. The Grid option shows a square grid. The Radial option shows a circular grid with radial angle lines.

Scroll History: Shows the sonar history on the side of the screen. Not available in Perspective mode.

Beam Icon: Selects the icon used to show the direction of the transducer beam.

Beam Overlay: Enables an outline to show where the transducers are oriented in relation to each other, when two or more calibrated Panoptix™ transducers are connected.

On-screen Control: Shows the on-screen buttons.

Reverse Range: Adjusts the amount of range shown behind the transducer.

Compress Range: In forward views, compresses the forward range farther away from the boat and expands the range closer to the boat. This allows you to see closer objects more clearly while keeping farther objects on the screen.

LiveScope and Perspective Transducer Installation Settings

From the LiveScope or Perspective sonar view, select **☰ > Sonar Setup > Installation**.

Install Depth: Sets the depth below the water line where the Panoptix™ transducer is mounted. Entering the actual depth at which the transducer is mounted results in a more accurate visual presentation of what is in the water.

Stabilization > Auto Stabilize: Enables the internal attitude heading sensors to detect the installation angle of the Panoptix transducer automatically. When this setting is turned on, you cannot manually specify the installation angle for the transducer.

Stabilization > Pitch Angle: Available only when Auto Stabilize is turned off. Allows you to enter the specific installation angle for the transducer. Many forward view transducers are installed at a 45-degree angle and down view transducers are installed at a zero-degree angle.

Stabilization > Flipped: Sets the orientation of the Panoptix sonar view when the down view transducer is installed with the cables pointing toward the port side of the boat.

This applies to Panoptix transducers in the LiveVü Down, RealVü 3D Down, and RealVü 3D Historical sonar views.

Calibrate Compass: Calibrates the internal compass in the Panoptix transducer ([Calibrating the Compass, page 86](#)).

This applies to LiveScope™ transducers with an internal compass.

Orientation: Controls if the transducer is in down or forward installation mode. The Auto setting uses the AHRS sensor to determine the orientation.

Focus: Adjusts the sonar view to compensate for the speed of sound in water. The Auto setting uses the temperature of the water to calculate the speed of sound.

Heading Source: Allows the system to reference the heading source from either the transducer or a compatible Garmin® trolling motor. This may help avoid interference from the trolling motor when the transducer is installed on the barrel. This setting appears only when a compatible Garmin trolling motor is detected.

Heading Offset: Adjusts the referenced heading to match the actual heading, if needed. This setting appears only when a compatible Garmin trolling motor is set as the heading source.

Restore Sonar Defaults: Restores the sonar settings to the factory default values.

Autopilot

WARNING

You can use the autopilot feature only at a station installed next to a helm, throttle, and helm control device.

You are responsible for the safe and prudent operation of your vessel. The autopilot is a tool that enhances your capability to operate your boat. It does not relieve you of the responsibility of safely operating your boat. Avoid navigational hazards and never leave the helm unattended.

Always be prepared to promptly regain manual control of your boat.

Learn to operate the autopilot on calm and hazard-free open water.

Use caution when operating the autopilot near hazards in the water, such as docks, pilings, and other boats.

The autopilot system continuously adjusts the steering of your boat to maintain a constant heading (heading hold). The system also allows manual steering and several modes of automatic-steering functions and patterns.

When the chartplotter is connected to a compatible Garmin® autopilot system, you can engage and control the autopilot from the chartplotter. For information about compatible Garmin autopilot systems, go to garmin.com.

When the chartplotter is connected to a compatible Yamaha® autopilot system, you can control the autopilot from the chartplotter using the Yamaha autopilot screen and overlay bar (*Yamaha® Autopilot, page 96*). For information about compatible Yamaha autopilot systems, contact your Yamaha dealer.

Autopilot Configuration

NOTICE

To avoid damage to your boat, the autopilot system should be installed and configured by a qualified marine installer. Specific knowledge of marine steering and electrical systems is required for proper installation and configuration.

The autopilot system must be configured to work properly with your boat. You can configure the autopilot using a chartplotter on the same NMEA 2000® network as the autopilot. For configuration instructions, go to support.garmin.com, and download the configuration guide for your specific autopilot model.

Selecting the Preferred Heading Source

NOTICE

For best results, use the autopilot CCU internal compass for the heading source. Using a third-party GPS compass can cause the data to be delivered erratically and may result in excessive delays. The autopilot needs timely information, and therefore cannot often use third-party GPS compass data for GPS location or speed. If a third-party GPS compass is used, the autopilot will likely report loss of navigation data and speed source periodically.

If you have more than one heading source on the network, you can select a your preferred source. The source could be a compatible GPS compass or a magnetic heading sensor.

1 From the autopilot screen, select **••• > Autopilot Setup > Preferred Sources**

2 Select a source.

If the selected heading source is unavailable, the autopilot screen does not display any data.

Opening the Autopilot Screen

Before you can open the autopilot screen, you must have a compatible Garmin® autopilot installed and configured.

Select **Vessel > Autopilot**.

Autopilot Screen

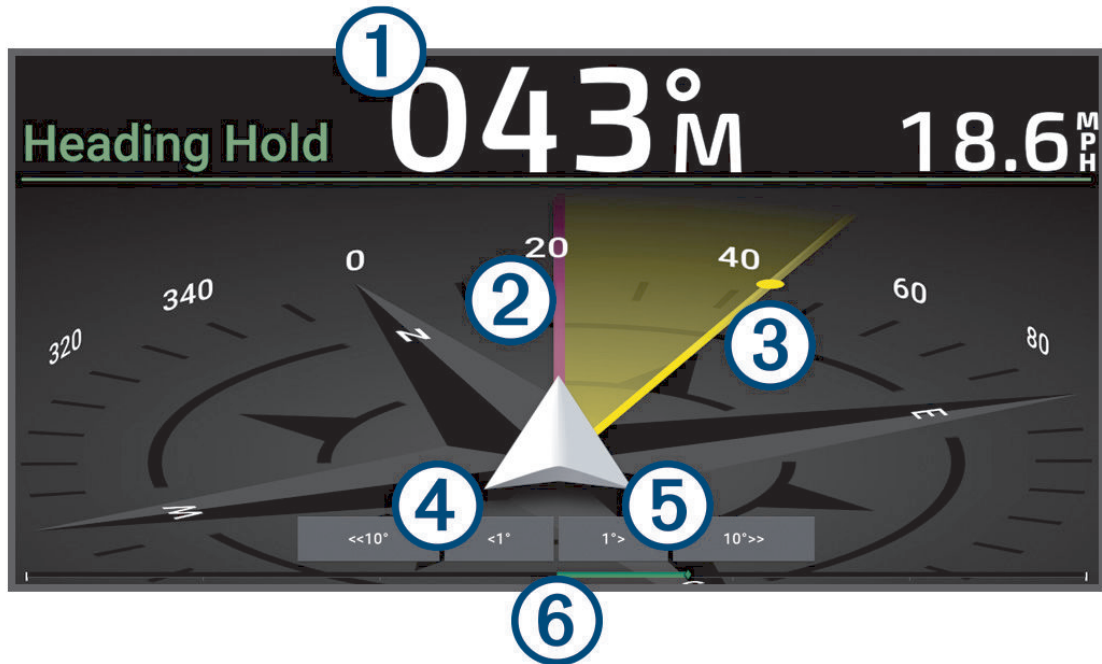

①	Actual heading (when in standby mode) Intended heading (when engaged)
②	Actual heading
③	Intended heading (heading the autopilot is steering toward)
④	Step turn to port (to adjust the intended heading by amount shown)
⑤	Step turn to starboard (to adjust the intended heading by amount shown)
⑥	Rudder position indicator (available when a rudder sensor is connected)

Adjusting the Step Steering Increment

- 1 From the autopilot screen, select **☰** > **Autopilot Setup** > **Step Turn Size**.
- 2 Select an increment.

Setting the Power Saver

You can adjust the level of rudder activity.

- 1 From the autopilot screen, select **☰** > **Autopilot Setup** > **Power Mode Setup** > **Power Saver**.
- 2 Select a percentage.

Selecting a higher percentage reduces rudder activity and heading performance. The higher the percentage, the more the course deviates before the autopilot corrects it.

TIP: In choppy conditions at low speeds, increasing the Power Saver percentage reduces rudder activity.

Enabling the Shadow Drive™ Feature

⚠ WARNING

If the Shadow Drive feature is disabled, steering the boat manually will not disengage the autopilot system. You must use the helm control or connected chartplotter to disengage the autopilot system.

NOTE: The Shadow Drive feature is not available on all autopilot models.

If the Shadow Drive feature has been disabled, you must enable it again before you can steer the boat manually to disengage the autopilot system.

- 1 From the autopilot screen, select **☰** > **Autopilot Setup** > **Shadow Drive Setup**.
- 2 If **Disabled** is shown, select **Shadow Drive** to enable the Shadow Drive feature.

The Shadow Drive feature is enabled. You can repeat these steps to disable the feature again.

Autopilot Overlay Bar

NOTE: Not all options are available on all autopilot models.

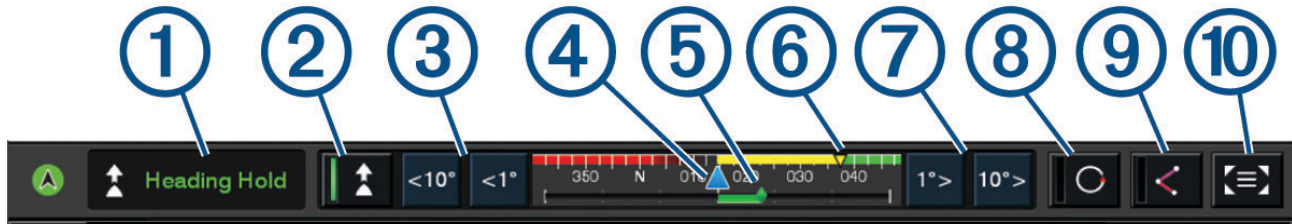

①	Autopilot status
②	Engages and disengages heading hold
③	Steers left
④	Actual heading
⑤	Rudder position indicator (available only when a rudder sensor is connected)
⑥	Intended heading (heading the autopilot is steering toward)
⑦	Steers right
⑧	Engages the last used steering pattern
⑨	Engages follow route mode (available only when autopilot is in standby status and navigating using Go To, Route To, or Auto Guidance)
⑩	Opens the full autopilot screen and menu

Engaging the Autopilot

When you engage the autopilot, the autopilot takes control of the helm and steers the boat to maintain your heading.

From any screen, select **Engage**.

Your intended heading shows in the center of the Autopilot screen.

Adjusting the Heading Using the Helm

NOTE: You must enable the Shadow Drive™ feature before you can adjust the heading using the helm while the autopilot is engaged .

With the autopilot engaged, manually steer the boat using the helm.

Shadow Drive and  at the top of the heading screen appear in yellow, and you have full steering control using the helm.

When you release the helm and maintain a specific heading for a few seconds, the autopilot resumes a heading hold at the new heading.

Adjusting the Heading with the Chartplotter in Step Steering Mode

1 Engage a heading hold ([Engaging the Autopilot, page 91](#)).

2 Select an option:

- Select <1° or 1°> to initiate a single 1° turn.
- Select <<10° or 10°>> to initiate a single 10° turn.
- Hold <1° or 1°> to initiate a rate-controlled turn.
The boat continues to turn until you let go of the key.
- Hold <<10° or 10°>> to initiate a sequence of 10° turns.

Steering Patterns

WARNING

You are responsible for the safe operation of your boat. Do not begin a pattern until you are certain the water is clear of obstacles.

The autopilot can steer the boat in preset patterns for fishing, and it can perform other specialty maneuvers such as U-turns and Williamson turns.

Following the U-Turn Pattern

You can use the u-turn pattern to turn the boat around 180 degrees and maintain the new heading.

- 1 From the autopilot screen, select **••• > Pattern Steering > U-Turn**.
- 2 Select **Engage Port** or **Engage Starboard**.

Setting Up and Following the Circles Pattern

You can use the circles pattern to steer the boat in a continuous circle, in a specified direction, and at a specified time interval.

- 1 From the autopilot screen, select **••• > Pattern Steering > Circles**.
- 2 If necessary, select **Time**, and select a time for the autopilot to steer one complete circle.
- 3 Select **Engage Port** or **Engage Starboard**.

Setting Up and Following the Zigzag Pattern

You can use the zigzag pattern to steer the boat from port to starboard and back, over a specified time and angle, across your present heading.

- 1 From the autopilot screen, select **••• > Pattern Steering > Zigzag**.
- 2 If necessary, select **Amplitude**, and select a degree.
- 3 If necessary, select **Period**, and select a length of time.
- 4 Select **Engage Zigzag**.

Following the Williamson Turn Pattern

You can use the Williamson turn pattern to steer the boat around with the intent of running alongside the location where the Williamson turn pattern was initiated. The Williamson turn pattern can be used in man overboard situations.

- 1 From the autopilot screen, select **••• > Pattern Steering > Williamson Turn**.
- 2 Select **Engage Port** or **Engage Starboard**.

Following an Orbit Pattern

You can use the orbit pattern to steer the boat in a continuous circle around the active waypoint. The size of the circle is defined by your distance from the active waypoint when you begin the orbit pattern.

- 1 From the autopilot screen, select **••• > Pattern Steering > Orbit**.
- 2 Select **Engage Port** or **Engage Starboard**.

Setting Up and Following the Cloverleaf Pattern

You can use the cloverleaf pattern to steer the boat to repeatedly pass over an active waypoint. When you begin the cloverleaf pattern, the autopilot drives the boat toward the active waypoint and begins the cloverleaf pattern.

You can adjust the distance between the waypoint and the location where the autopilot turns the boat for another pass over the waypoint. The default setting turns the boat at a range of 1000 ft. (300 m) from the active waypoint.

- 1 From the autopilot screen, select **••• > Pattern Steering > Cloverleaf**.
- 2 If necessary, select **Length**, and select a distance.
- 3 Select **Engage Port** or **Engage Starboard**.

Setting Up and Following a Search Pattern

You can use the search pattern to steer the boat in increasingly larger circles outward from the active waypoint, forming a spiral pattern. When you begin the search pattern, the autopilot immediately drives the boat in a circle centered on the active waypoint and expands the spiral as it completes each circle.

You can adjust the distance between each circle in the spiral. The default distance between circles is 50 ft. (20 m).

- 1 From the autopilot screen, select **••• > Pattern Steering > Search**.
- 2 If necessary, select **Search Spacing**, and select a distance.
- 3 Select **Engage Port** or **Engage Starboard**.

Cancelling a Steering Pattern

- Physically steer the boat.
NOTE: Shadow Drive™ feature must be enabled to cancel a steering pattern by physically steering the boat.
- Select **<** or **>** to cancel a pattern using step steering mode.
- Select **Standby**.

Adjusting the Autopilot Response

The Response setting allows you to adjust the autopilot responsiveness for varying sea and wind conditions. For advanced autopilot configuration, see the configuration guide included with your autopilot system.

- 1 From the autopilot screen, select **••• > Response**.
- 2 Adjust the rudder response.
If you want the rudder to be more responsive and move more quickly, increase the value. If the rudder is too responsive and moving too quickly, decrease the value.

Enabling Auto Response

When using the autopilot system on a Sailboat or a Sailing Catamaran vessel, you can set the response setting to Auto so that the autopilot system automatically adjusts the response setting based on sea conditions. The Auto setting automatically lowers the response setting to Low (4) in calm sea conditions, and raises it to Normal in rough sea conditions. The autopilot system uses pitch and roll information to determine sea conditions, as well as wind data, if available.

- 1 From the autopilot screen, select **••• > Response**.
- 2 Select **Auto** repeatedly until it shows the preferred sensitivity level, **Low** through **High**.
The response setting will adjust automatically based on sea conditions. The higher you set the auto response setting, the system will be more sensitive to pitch, roll, and wind data when adjusting the response.

Low-Speed Autopilot Mode

If you operate the autopilot system at very low speeds, when trolling for example, you can enable a low-speed mode that is more responsive in these situations.

The low-speed autopilot mode must be enabled before you can use it, and is available only for Power Planing Hull or Power Displacement Hull vessels with the Speed Source set to GPS.

Enabling and Disabling Low-Speed Autopilot Mode

By default, the low-speed autopilot mode is disabled, and you must enable it in the autopilot settings before you can use it.

- 1 From the autopilot screen, select **••• > Autopilot Setup > Autopilot Installation Setup > Speed Source Setup**.
- 2 Select **Autopilot Low Speed**.
Low-speed autopilot mode is enabled.
- 3 Select **Autopilot Low Speed** again to disable low-speed autopilot mode.

Engaging and Disengaging Low Speed Autopilot Mode

You must enable low-speed autopilot mode in the Autopilot Installation Setup menu before you can engage low-speed autopilot mode.

- 1 When driving the boat at a low speed (under 1 kn.), engage the heading hold.
A message banner appears asking if you would like to engage the low-speed autopilot heading hold.
- 2 Select **Low Speed** to engage low-speed mode.
If you select Cancel or do nothing, the autopilot remains in normal heading hold.
The autopilot system operates with increased sensitivity and reaction for better performance at low speeds.
- 3 To disengage low-speed mode, disengage the autopilot or increase the boat speed above 12 kn.

Enabling the Autopilot Controls on a Garmin® Watch

You can control the Garmin autopilot with a compatible Garmin watch. Go to garmin.com for a list of compatible Garmin devices. For more information, see the owner's manual for your compatible Garmin watch.

NOTE: Smart notifications are not available on your watch when the autopilot remote control is enabled.

TIP: In addition to controlling an autopilot system, you can also use a compatible Garmin watch to control or view other features on the chartplotter:

- You can use the screen and buttons as a remote control to navigate the user interface (*Pairing a Garmin® Watch to Control a Garmin Chartplotter, page 30*).
- You can view important data about your boat, such as depth and speed (*Viewing Boat Data on a Garmin® Watch, page 29*).

- 1 Select **Communications > Wireless Devices > Wearables > Autopilot Control > Enable > New Connection**.
- 2 Follow the on-screen instructions.

Customizing the Autopilot Button Actions

Before you can set the autopilot button actions, you must install and configure a compatible Garmin® autopilot. You can select up to three autopilot actions for your Garmin watch to perform.

NOTE: Available autopilot actions depend on the autopilot installed.

- 1 On the chartplotter, select **Communications > Wireless Devices > Connect IQ™ Apps > Autopilot Control > Button Actions**.
- 2 Select a button.
- 3 Select an action.

Reactor™ Autopilot Remote Control

WARNING

You are responsible for the safe and prudent operation of your vessel. The autopilot is a tool that enhances your capability to operate your boat. It does not relieve you of the responsibility of safely operating your boat. Avoid navigational hazards and never leave the helm unattended.

You can wirelessly connect a Reactor autopilot remote control to the chartplotter to control the compatible Reactor autopilot system.

For more information about using the remote, see the Reactor autopilot remote control instructions at garmin.com

Pairing a Reactor™ Autopilot Remote Control With a Chartplotter

- 1 Select **••• > Communications > Wireless Devices > Wireless Remotes > Autopilot Remote**.
- 2 If necessary, select **Enable**.
- 3 Select **New Connection**.
- 4 On the remote control, select  **> Pair with MFD**.
The chartplotter beeps and shows a confirmation message.
- 5 On the chartplotter, select **Yes** to complete the pairing process.

Changing the Functions of the Reactor™ Autopilot Remote Control Action Keys

You can change the patterns or actions assigned to the Reactor autopilot remote control action keys.

- 1 Select  **> Communications > Wireless Devices > Wireless Remotes > Autopilot Remote > Button Actions**.
- 2 Select an action key to change.
- 3 Select a pattern or action to assign to the action key.

Updating the Reactor™ Autopilot Remote Control Software

You can update the Reactor autopilot remote control software using the chartplotter.

- 1 Insert a memory card into the card slot on the computer.
- 2 Go to garmin.com/software/autopilot_remote_control, and select **Software**.
- 3 Select **Download**.
- 4 Read and agree to the terms.
- 5 Select **Download**.
- 6 Choose a location, and select **Save**.
- 7 Double-click the downloaded file.
- 8 Select **Next**.
- 9 Select the drive associated with the memory card, and select **Next > Finish**.

10 On the chartplotter, insert the memory card into the card slot.

11 Select  > **Communications** > **Wireless Devices** > **Autopilot Remote** > **Update Software**.

Autopilot Keypad

WARNING

You are responsible for the safe and prudent operation of your vessel. The autopilot is a tool that enhances your capability to operate your boat. It does not relieve you of the responsibility of safely operating your boat. Avoid navigational hazards and never leave the helm unattended.

You can connect a APK™ 10 autopilot keypad to the same NMEA 2000® network as the chartplotter to control the compatible Reactor™ autopilot system.

For more information about installing and using the keypad, see the APK 10 autopilot keypad instructions at garmin.com

Function Key Default Actions

The two function keys are programmed with default actions based on the vessel type.

Vessel Type	Function Key 1	Function Key 2
Power Planing Hull and Power Displacement Hull	Circle (pattern)	Route Follow
Sailing and Sailing Catamaran	Tack/Gybe	Wind Hold

Configuring the Function Keys

The two keys labeled 1 and 2 on the keypad can be configured using a compatible chartplotter or a GHC™ 50 helm control connected to the autopilot system.

- 1 From the autopilot screen, select **•••** > **Autopilot Setup** > **Autopilot Keypad** > **Autopilot Keypad Configuration**
- 2 Select an option:
 - To configure the key labeled **1**, select **Key 1**.
 - To configure the key labeled **2**, select **Key 2**.
- 3 Select the function you want to assign to the key.
- 4 Repeat this procedure for the other key, if needed.

Power Steering Mode

CAUTION

When using a jog lever in power steering mode, the autopilot system does not establish a heading hold. You are responsible for the safe operation of your boat.

When using a GNA™ 10 adapter to connect a jog lever to an autopilot system installed on a power displacement hull vessel, you can enable an optional power steering mode to use the jog lever to steer the vessel with no autopilot intervention. When using the jog lever in power steering mode, it behaves differently than using it in the standard autopilot heading hold or when using the autopilot to follow a route.

When using a jog lever while in standard autopilot heading hold, pressing or holding the jog lever port or starboard turns the boat until you release the jog lever. The autopilot system then resumes a heading hold for your new heading, making adjustments as needed to maintain the new heading.

When using a jog lever while following a route using the autopilot system, pressing or holding the jog lever port or starboard stops following the route and turns the boat until you release the jog lever. The autopilot system then resumes a heading hold for your new heading, making adjustments as needed to maintain the new heading. It does not resume the initial route.

When using the jog lever while in power steering mode, pressing or holding the jog lever port or starboard turns the boat until you release the jog lever. The autopilot system does not establish a heading hold and the rudder stays in the position where you released the jog lever.

Enabling Power Steering Mode

Before you can select the option to Engage Power Steering on the chartplotter or helm control device, you must first enable power steering mode in the autopilot settings.

NOTE: The option to enable power steering mode is available only when the GNA™ 10 adapter is installed correctly and the vessel type is set to power planing.

From the autopilot page, select **•••** > **Autopilot Setup** > **Power Steering**.

The Power Steering setting is enabled, and the option to Engage Power Steering is now available in the autopilot menu.

Yamaha® Autopilot

⚠ WARNING

You can use the autopilot feature only at a station installed next to a helm, throttle, and helm control device.

You are responsible for the safe and prudent operation of your vessel. The autopilot is a tool that enhances your capability to operate your boat. It does not relieve you of the responsibility of safely operating your boat. Avoid navigational hazards and never leave the helm unattended.

Always be prepared to promptly regain manual control of your boat.

Learn to operate the autopilot on calm and hazard-free open water.

Use caution when operating the autopilot near hazards in the water, such as docks, pilings, and other boats.

The autopilot system continuously adjusts the steering of your boat to maintain a constant heading (heading hold).

When the chartplotter is connected to a compatible Yamaha autopilot system, you can view the autopilot information using the Yamaha autopilot screen and overlay bar. For information about compatible Yamaha autopilot systems, contact your Yamaha dealer.

Yamaha® Autopilot Screen

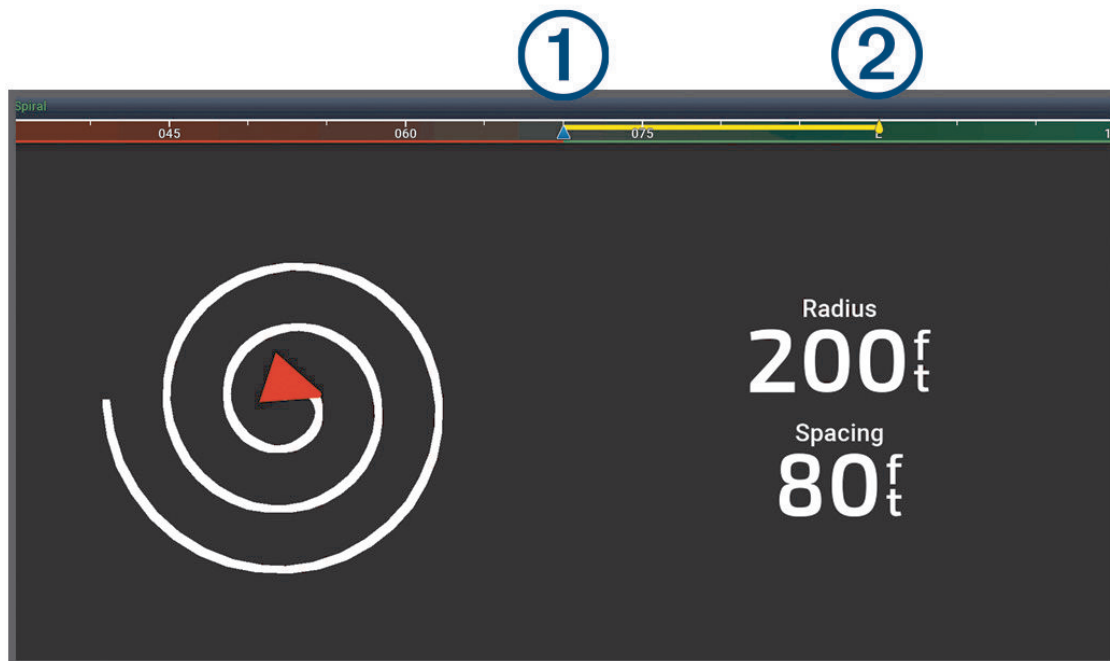

①	Actual heading
②	Intended heading (heading the autopilot is steering toward)

Yamaha® Autopilot Settings

From a Yamaha engine screen, select **••• > Autopilot Setting**.

Pattern Set: Allows you to select an autopilot pattern.

Direction: Sets a port or starboard direction for the pattern.

Spacing: Sets the spacing for the pattern.

Length: Sets the length of the pattern.

Amplitude: Sets the angle for the zigzag pattern.

Initial Radius: Sets the radius of the spiral pattern.

Final Track Point Mode: Sets the mode for the autopilot when it reaches the end of a route. The FishPoint® option maintains the position, but does not maintain the heading. The DriftPoint® option allows the boat to

drift with the wind or current while maintaining the selected heading, but does not maintain the position. The StayPoint® option maintains the position and the heading. The Deceleration option stops the motor, but does not maintain the position or heading. The No Deceleration option does not stop the motor.

Course Hold Offset: Sets a distance to navigate parallel to a route.

NOTE: Detailed information on the operation of the Yamaha Joystick and Autopilot system can be found in the *Quick Guide* included with the latest Joystick/Autopilot kit.

Yamaha® Autopilot Overlay Bar

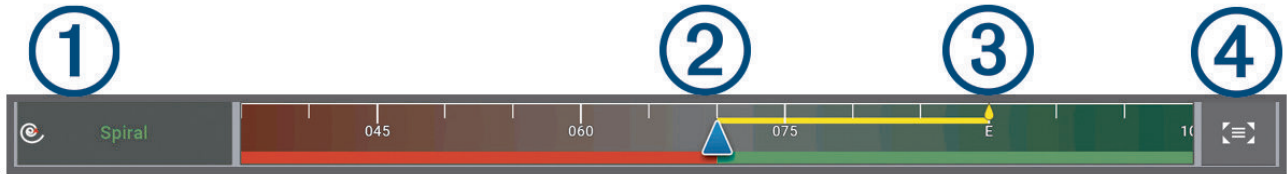

①	Autopilot mode
②	Actual heading
③	Intended heading (heading the autopilot is steering toward)
④	Opens the full autopilot screen and menu

Force® Trolling Motor Control

⚠ WARNING

Do not run the motor when the propeller is out of the water. Contact with the rotating propeller may result in severe injury.

Do not use the motor in areas where you or other people in the water may come into contact with the rotating propeller, which could result in severe injury.

Always disconnect the motor from the battery before handling or working with the propeller, propeller drive motor, electrical connections, or electronics enclosures to avoid serious injury or death.

You are responsible for the safe and prudent operation of your vessel. The autopilot features on the trolling motor are tools that enhance your capability to operate your boat. They do not relieve you of the responsibility of safely operating your boat. Avoid navigational hazards and never leave the motor controls unattended.

Learn to operate the autopilot on calm and hazard-free open water.

Use caution when operating the autopilot near hazards in the water, such as docks, pilings, and other boats.

⚠ CAUTION



When using the autopilot features, be prepared for sudden stops, acceleration, and turns.

When stowing or deploying the motor, maintain stable footing and be aware of slick surfaces around the motor. Losing your footing while stowing or deploying the motor may result in injury.

You can connect the Force trolling motor to the chartplotter to view and control the motor using the chartplotter.

Connecting to a Trolling Motor



You can connect the chartplotter wirelessly to a compatible Garmin® Force® trolling motor on your boat to control the trolling motor from the chartplotter.

- 1 Turn on the chartplotter and the trolling motor.
- 2 Enable the Wi-Fi® network on the chartplotter (*Setting Up the Wi-Fi® Network, page 28*).
- 3 If multiple chartplotters are connected on the Garmin Marine Network, make sure this chartplotter is the host of the Wi-Fi network (*Changing the Wi-Fi® Host, page 29*).
- 4 On the chartplotter, select  > **Communications** > **Wireless Devices** > **Garmin Trolling Motor**.
- 5 On the trolling motor display panel, press  three times to enter pairing mode.
 on the trolling motor display panel is solid blue as it searches for a connection to the chartplotter, and turns green when the connection is successful.

After the chartplotter and trolling motor connect successfully, enable the trolling motor overlay bar to control the motor (*Adding the Trolling Motor Controls to Screens, page 98*).

Adding the Trolling Motor Controls to Screens

After you have connected the chartplotter to the Force® trolling motor, you must add the trolling motor control bar to screens to control the trolling motor.

- 1 Open a screen from which you would like to control the trolling motor.
- 2 Select an option:
 - From a full screen, select  > **Edit Overlays**.
 - From a combination screen, select  > **Edit** > **Overlays**.
- 3 Select **Top Bar, Bottom Bar, Left Bar, or Right Bar**.
- 4 Select **Trolling Motor Bar**.

Repeat these steps to add the trolling motor controls to all of the screens from which you would like to control the trolling motor.

Trolling Motor Control Bar

The trolling motor control bar allows you to control a Force® trolling motor and see the status of the motor. Select an item to engage it. The button illuminates when selected. Select the item again to disengage it.

1

2



	Trolling motor battery status.
	Turns the propeller on and off.
	Reduces the speed. When the speed reaches 0, continuing to reduce the speed shifts the propeller into reverse thrust.
	Speed indicator.
	Increases the speed. If you are running the propeller in reverse thrust, increasing the speed past 0 shifts the propeller into forward thrust.
	Enables the cruise control at the current speed over ground (SOG).
	Engages the propeller at full speed.
	Trolling motor status.
	Enables anchor lock, which uses the trolling motor to hold your position.
	Steers the trolling motor. When in anchor lock, jogs the anchor lock position forward, backward, left, or right.
	Enables heading hold (set and maintain the current heading). When the trolling motor is in heading hold, an autopilot bar appears in the trolling motor bar.
	Shifts between forward and reverse mode. NOTE: When shifting between forward and reverse mode, the propeller speed is automatically set to the last speed you used in the same thrust mode. Shifting between forward and reverse thrust automatically turns the propeller off. Shifting between forward and reverse thrust while in an autopilot mode automatically reverts the motor to manual mode.
	Opens the trolling motor settings.

Reverse Thrust

In manual mode, you can run the propeller in reverse. Running the propeller in reverse for short periods of time can be useful in some situations, such as backing out of a tight space with less steering of the motor. Because the propeller on the trolling motor is designed primarily for forward thrust, it is less efficient at creating reverse thrust, resulting in more noise from the motor, especially at higher propeller speeds, and more turbulence underwater.

NOTICE

You should use reverse thrust sparingly to minimize cavitation and excessive wear on the propeller and the propeller drive motor.

Trolling Motor Settings

From the trolling motor bar, select

Calibrate: Calibrates the trolling motor compass ([Calibrating the Trolling Motor Compass, page 100](#)) and sets the trolling motor bow offset ([Setting the Bow Offset, page 100](#)).

Anchor Gain: Sets the response of the trolling motor when in anchor lock mode. If you need the trolling motor to be more responsive and move quicker, increase the value. If the motor is moving too much, decrease the value.

Navigation Gain: Sets the response of the trolling motor when navigating. If you need the trolling motor to be more responsive and move quicker, increase the value. If the motor is moving too much, decrease the value.

Heading Hold Mode: Sets the heading hold mode. The Vessel Align option attempts to keep the boat pointing in the same direction regardless of drift. The Go To option attempts to navigate a straight line in the requested direction.

Arrival Mode: Sets the behavior of the trolling motor when you reach the end of a route. With the Anchor Lock setting, the trolling motor holds the position using the anchor lock feature when the boat reaches the end of the route. With the Manual setting, the propeller turns off when the boat reaches the end of the route.

⚠ CAUTION

You are responsible for the safe operation of your boat. When using the Manual setting for the Arrival Mode option, you must be ready to take control of the boat.

Auto Power On: Turns on the trolling motor when you apply power to the system.

Prop. Stow Side: Sets which side of the trolling motor the propeller rotates to when stowing the trolling motor. This is helpful when you store other items near the stowed propeller.

Shortcut Keys: Enables the shortcut keys on the trolling motor remote control to work with this particular chartplotter. The keys work with only one chartplotter at a time.

Restore Defaults: Resets the trolling motor settings to the factory default values.

Assigning a Shortcut to the Trolling Motor Remote Control Shortcut Keys

You can quickly open commonly used screens by assigning a shortcut key on the trolling motor remote control. You can create a shortcut to screens, such as sonar screens and charts.

NOTE: If you have more than one chartplotter on the network, you can assign shortcut keys to one chartplotter only.

- 1 Open a screen.
- 2 Hold a shortcut key.

TIP: The shortcut is also saved to the Pinned category with the shortcut key number.

Calibrating the Trolling Motor Compass

You must calibrate the compass in the trolling motor before you can use the autopilot features.

- 1 Drive the boat to an open area of calm water.
- 2 From the trolling motor bar, select  > **Calibrate** > **Compass Cal..**
- 3 Follow the on-screen instructions.

Setting the Bow Offset

Based on the installation angle, the trolling motor may not align with the center line of your boat. For the best results, you should set the bow offset.

- 1 Adjust the angle of the trolling motor  so it aligns with the center line of your boat , pointing straight forward.

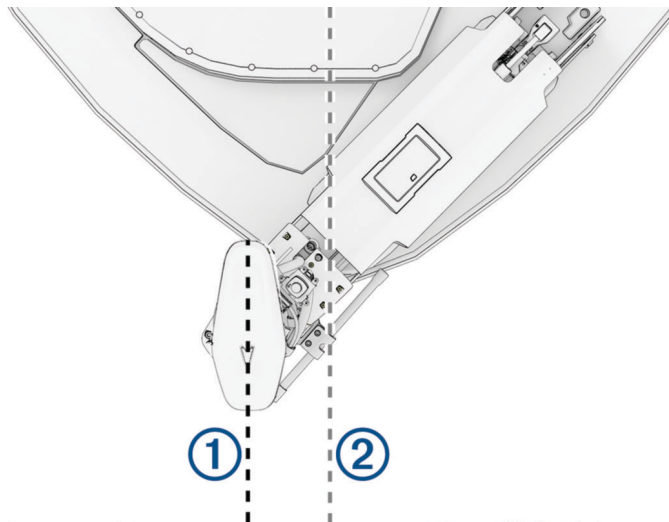

- 2 From the trolling motor bar, select  > **Calibrate** > **Bow Offset**.

Calibrating the Steering Alignment

The Garmin® trolling motor shaft is aligned at the factory by Garmin, and should not need regular alignment. Occasionally, due to an impact or an unexpected manual shaft rotation, the trolling motor steering may appear off, or you may receive an error message regarding the steering alignment. You can perform this alignment procedure to correct this type of error.

- 1 Deploy the trolling motor.
- 2 From the trolling motor bar, select  > **Calibrate** > **Steering Alignment**.
- 3 Follow the on-screen instructions and select **Begin**.

NOTICE

The trolling motor will perform a number of steering motions during the calibration process.

- 4 Wait until the calibration process is complete.

Digital Selective Calling

Networked Chartplotter and VHF Radio Functionality

When you connect a compatible VHF radio to your chartplotter, these features are enabled.

- The chartplotter can transfer your GPS position to your radio. If your radio is capable, GPS position information is transmitted with DSC calls.
- The chartplotter can receive digital selective calling (DSC) distress and position information from the radio.
- The chartplotter can track the positions of vessels sending position reports.

If you have a Garmin® NMEA 2000® VHF radio connected to your chartplotter, these features are also enabled.

- The chartplotter allows you to quickly set up and send individual routine call details to your Garmin VHF radio.
- When you initiate a man-overboard distress call from your radio, the chartplotter shows the man-overboard screen and prompts you to navigate to the man-overboard point.

For information about installing and connecting a VHF radio, see the VHF radio installation instructions.

Turning On DSC

Select  > **Other Vessels** > **DSC**.

DSC List

The DSC list is a log of the most recent DSC calls and other DSC contacts you have entered. The DSC list can contain up to 100 entries. The DSC list shows the most recent call from a boat. If a second call is received from the same boat, it replaces the first call in the call list.

You can view the DSC list from the messages and warnings menu ([Messages and Warnings, page 135](#)).

Viewing the DSC List

Before you can view the DSC list, the chartplotter must be connected to a VHF radio that supports DSC.

From a chart or 3D chart view, select **•••** > **Layers** > **Other Vessels** > **DSC** > **DSC List**.

TIP: You can quickly access the DSC list from the messages and warnings menu ([Messages and Warnings, page 135](#)).

Adding a DSC Contact

You can add a vessel to your DSC list. You can make calls to a DSC contact from the chartplotter.

- 1 From a chart or 3D chart view, select **•••** > **Layers** > **Other Vessels** > **DSC** > **DSC List** > **Add Contact**.

TIP: You can quickly access the DSC list from the messages and warnings menu ([Messages and Warnings, page 135](#)).

- 2 Enter the Maritime Mobile Service Identity (MMSI) of the vessel.
- 3 Enter the name of the vessel.

Incoming Distress Calls

If your chartplotter is connected to a compatible VHF radio, your chartplotter alerts you when your VHF radio receives a DSC distress call. If position information was sent with the distress call, that information is also available and recorded with the call.

 designates a distress call in the DSC list and marks the position of the vessel on the Navigation chart at the time of the DSC distress call.

Navigating to a Vessel in Distress

The  icon designates a distress call in the DSC list and marks the position of a vessel on the Navigation chart at the time of the DSC distress call.

- 1 From a chart or 3D chart view, select **•••** > **Layers** > **Other Vessels** > **DSC** > **DSC List**.

TIP: You can quickly access the DSC list from the messages and warnings menu ([Messages and Warnings, page 135](#)).

- 2 Select a position-report call.
- 3 Select **Review** > **Navigate To**.
- 4 Select **Go To** or **Route To**.

Man-Overboard Distress Calls Initiated from a VHF Radio

When the chartplotter is connected to a compatible VHF radio with NMEA 2000®, and you initiate a man-overboard DSC distress call from the radio, the chartplotter shows the man-overboard screen and prompts you to navigate to the man-overboard point. If you have a compatible autopilot system connected to the network, the chartplotter prompts you to start a Williamson's turn to the man-overboard point.

If you cancel the man-overboard distress call on the radio, the chartplotter screen prompting you to activate navigation to the man-overboard location disappears.

Position Tracking

You can connect a VHF radio to the same NMEA 2000® network as the chartplotter to send position reports and track vessels that send position reports. The vessel must send the correct PGN data (PGN 129808; DSC Call Information) to use this feature.

Every position report call received is logged in the DSC list ([DSC List](#), page 102).

Viewing a Position Report

- 1 From a chart or 3D chart view, select **••• > Layers > Other Vessels > DSC > DSC List**.

TIP: You can quickly access the DSC list from the messages and warnings menu ([Messages and Warnings](#), page 135).

- 2 Select a position-report call.
- 3 Select **Review**.
- 4 Select an option:
 - To view the position report details, select **>**.
 - To view to a chart marking the location, select **<**.

Navigating to a Tracked Vessel

- 1 From a chart or 3D chart view, select **••• > Layers > Other Vessels > DSC > DSC List**.

TIP: You can quickly access the DSC list from the messages and warnings menu ([Messages and Warnings](#), page 135).

- 2 Select a position-report call.
- 3 Select **Review > Navigate To**.
- 4 Select **Go To** or **Route To**.

Creating a Waypoint at the Position of a Tracked Vessel

- 1 From a chart or 3D chart view, select **••• > Layers > Other Vessels > DSC > DSC List**.

TIP: You can quickly access the DSC list from the messages and warnings menu ([Messages and Warnings](#), page 135).

- 2 Select a position-report call.
- 3 Select **Review > Create Waypoint**.

Editing Information in a Position Report

- 1 From a chart or 3D chart view, select **••• > Layers > Other Vessels > DSC > DSC List**.

TIP: You can quickly access the DSC list from the messages and warnings menu ([Messages and Warnings](#), page 135).

- 2 Select a position-report call.
- 3 Select **Review > Edit**.
 - To enter the name of the vessel, select **Name**.
 - To select a new symbol, select **Symbol**, if available.
 - To enter a comment, select **Comment**.
 - To show a trail line for the vessel if your radio is tracking the position of the vessel, select **Trail**.
 - To select a color for the trail line, select **Trail Line**.

Deleting a Position-Report Call

- 1 From a chart or 3D chart view, select **••• > Layers > Other Vessels > DSC > DSC List**.

TIP: You can quickly access the DSC list from the messages and warnings menu ([Messages and Warnings](#), page 135).

- 2 Select a position-report call.
- 3 Select **Review > Edit > Clear Report**.

Viewing Vessel Trails on the Chart

You can view trails for all tracked vessels on some chart views. By default, a black line indicates the path of the vessel, a black dot indicates each previously reported position of a tracked vessel, and a blue flag indicates the last reported position of the vessel.

- 1 From a chart or 3D chart view, select **••• > Layers > Other Vessels > DSC > DSC Trails**.
- 2 Select the number of hours to show tracked vessels on the chart.
For example, if you select 4 Hours, all trail points that are less than four hours old appear for all tracked vessels.

Individual Routine Calls

When you connect the chartplotter to a Garmin® VHF radio, you can use the chartplotter interface to set up an individual routine call.

When setting up an individual routine call from your chartplotter, you can select the DSC channel on which you want to communicate. The radio transmits this request with your call.

Selecting a DSC Channel

NOTE: The selection of a DSC channel is limited to those channels that are available in all frequency bands. The default channel is 72. If you select a different channel, the chartplotter uses that channel for subsequent calls until you call using another channel.

- 1 From a chart or 3D chart view, select **••• > Layers > Other Vessels > DSC > DSC List**.
TIP: You can quickly access the DSC list from the messages and warnings menu (*Messages and Warnings*, page 135).
- 2 Select a vessel or a station to call.
- 3 Select **Review > Call with Radio > Channel**.
- 4 Select an available channel.

Making an Individual Routine Call

NOTE: When initiating a call from the chartplotter, if the radio does not have an MMSI number programmed, the radio will not receive call information.

- 1 From a chart or 3D chart view, select **••• > Layers > Other Vessels > DSC > DSC List**.
TIP: You can quickly access the DSC list from the messages and warnings menu (*Messages and Warnings*, page 135).
- 2 Select a vessel or a station to call.
- 3 Select **Review > Call with Radio**.
- 4 If necessary, select **Channel**, and select a new channel.
- 5 Select **Send**.
The chartplotter sends information about the call to the radio.
- 6 On your Garmin® VHF radio, complete the call.

Making an Individual Routine Call to an AIS Target

- 1 From a chart or 3D chart view, select an AIS target.
- 2 Select **AIS Vessel > Call with Radio**.
- 3 If necessary, select **Channel**, and select a new channel.
- 4 Select **Send**.
The chartplotter sends information about the call to the radio.
- 5 On your Garmin® VHF radio, complete the call.

Gauges and Graphs

The gauges and graphs provide various information about the engine and environment. To view the information, a compatible transducer or sensor must be connected to the network.

Viewing the Gauges

- 1 Select **Gauges**.
- 2 Select a gauge, such as **Vessel**.

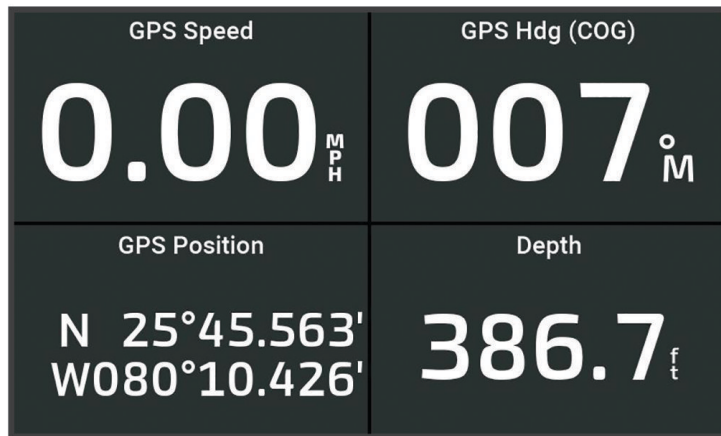

- 3 Select **<** or **>** to view a different gauge page, if applicable.

Engine Alert Icons

If an icon lights up on the gauges page, it indicates an issue with the motor.

	Low oil level or oil pressure alert
	Temperature alert
	Battery voltage alert
	Check engine alert

Changing the Data Shown in a Gauge

- 1 Open a gauge page.
- 2 Select **⋮ > Edit Gauge Pages**.
- 3 Select a gauge to edit.
TIP: You can hold any gauge to quickly change the data.

- 4 Select **Replace Data**.
- 5 Select a data type.
- 6 Select the data to display.

Customizing the Gauges

You can add a gauge page, change the layout of the gauge page, change how the gauges are displayed, and change the data in each gauge.

- 1 Open a gauge page.
- 2 Select **⋮ > Edit Gauge Pages**.
- 3 If necessary, select a gauge view or gauge to edit.
- 4 Select an option:
 - To change the data shown in a gauge, select the gauge and select **Replace Data**.
 - To change the layout of the gauges on the page, select **Change Layout**.
 - To add a page to this set of gauge pages, select **Add Page**.
 - To remove a page from this set of gauge pages, select **Remove Page**.
 - To change the order of this page in the set of gauge pages, select **Move Page Left** or **Move Page Right**.
 - To restore this page to the original view, select **Restore Default View**.

Customizing Engine Gauge and Fuel Gauge Limits

You can configure the upper and lower limits and the range of desired standard operation of a gauge.

NOTE: Not all options are available for all gauges.

- 1 From an applicable gauges screen, select **••• > Installation > Set Gauge Limits**.
- 2 Select a gauge to customize.
- 3 Select an option:
 - To set the minimum value of the standard operating range, select **Rated Min..**
 - To set the maximum value of the standard operating range, select **Rated Max..**
 - To set the lower limit of the gauge lower than the rated minimum, select **Scale Min..**
 - To set the upper limit of the gauge higher than the rated maximum, select **Scale Max..**
- 4 Select the limit value.
- 5 Repeat steps 4 and 5 to set additional gauge limits.

Selecting the Number of Engines Shown in Gauges

You can show information for up to four engines.

- 1 From the engine gauges screen, select **••• > Installation > Engine Selection > Num. Engines**.
- 2 Select an option:
 - Select the number of engines.
 - Select **Auto Configure** to automatically detect the number of engines.

Customizing the Engines Shown in Gauges

Before you can customize how the engines are shown in the gauges, you must manually select the number of engines ([Selecting the Number of Engines Shown in Gauges, page 106](#)).

- 1 From the engine gauges screen, select **••• > Installation > Engine Selection > Num. Engines**.
- 2 Select **First Engine**.
- 3 Select the engine to display in the first gauge.
- 4 Repeat for the remaining engine bars.

Enabling Status Alarms for Engine Gauges

You can enable the chartplotter to display engine status alarms.

From the engine gauges screen, select **••• > Installation > Status Alarms > On**.

When an engine alarm is triggered, a gauge status alarm message appears and the gauge may become red depending on the type of alarm.

Enabling Some Engine Gauge Status Alarms

- 1 From the engine gauges screen, select **••• > Installation > Status Alarms > Custom**.
- 2 Select one or more engine gauge alarms to turn on or off.

Yamaha® Engine and Motor Gauges

For the best experience monitoring and controlling your compatible Yamaha engine or motor using this chartplotter, you must connect your engine or motor to the chartplotter using the appropriate interface adapter. If needed, contact your Yamaha dealer for more information.

Select **Gauges > YAMAHA** to view the Yamaha engine gauges.

This image is only one example of how this screen may appear based on the number and types of engines or motors connected to the engine network and throttle controller. Consult the owner's manual provided with your Yamaha engine, motor, or display for complete information.

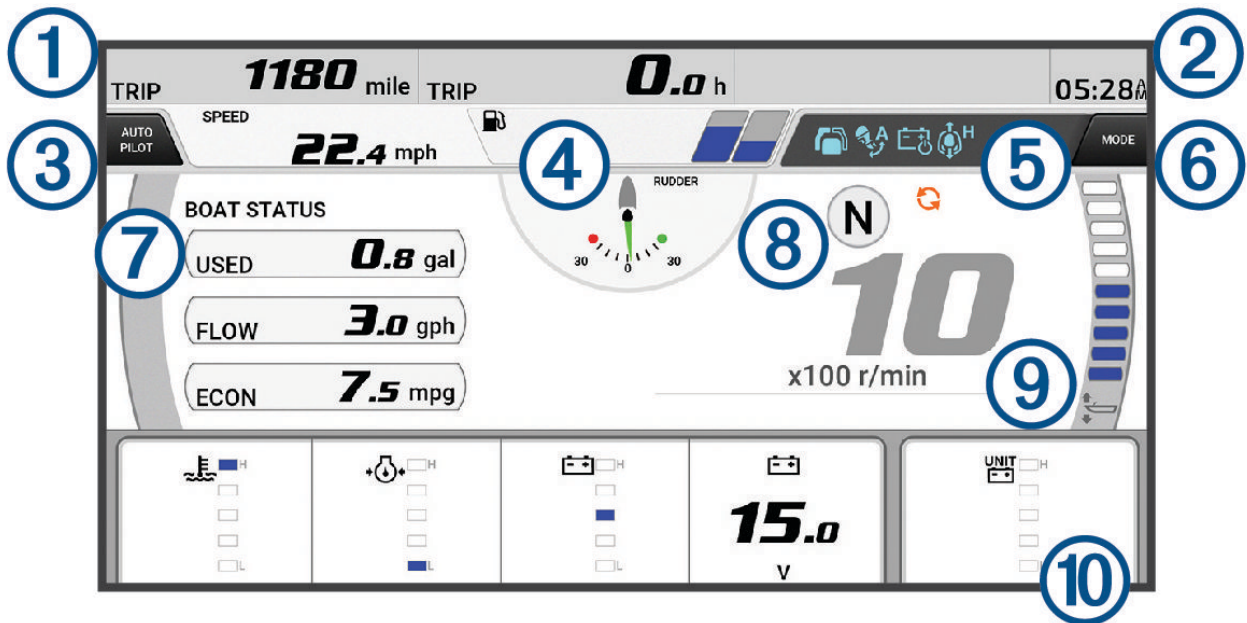



①	Boat data fields Hold to replace the data.
②	Current time Hold to view trip data.
③	Select to toggle the autopilot bar on and off (Helm Master® EX). Select to set the joystick button for Set Point functions (Helm Master and Helm Master EX).
④	Tank level information or battery level information Hold a tank or a battery to view detailed tank level sensor or battery level information.
⑤	Status icons: <ul style="list-style-type: none"> • Blue: engine or motor function indicators • Orange: engine or motor status or condition information • Red: engine or motor warning and alert information GPS signal strength (Helm Master)
⑥	Select to set the Fish Point settings (Helm Master/Helm Master EX). Select to set the trolling speed (Helm Master/Helm Master EX/Mechanical RC/Digital Electronic RC (6X6/6X7)).
⑦	Boat data fields Hold to replace the data.
⑧	Shift position indicator Engine RPM
⑨	Tachometer and trim angle Hold to change the background.
⑩	Engine, motor, and boat data fields Hold to replace the data and change the gauge appearance.

Engine and Motor Function Icons





Blue icons indicate the status of engine or motor functions.

	The autopilot is active.
	Speed control is active.
	Single lever control is active.
	Trim assist is active.
	The Battery Management System (BMS) is active.

	Joystick hold is active.
	Wave assist is active.

Engine and Motor Status Icons

Orange icons indicate engine or motor status conditions.









	Yamaha® security system is on.
	Engines are under synchronization control.
	Engines are warming up.
	The engine or motor output is limited.
	The Battery Management System (BMS) is off.

Engine and Motor Warning Icons

Red icons indicate engine or motor abnormalities.

NOTICE

Consult your Yamaha® dealer if the problem cannot be located and corrected.

	Low cooling water pressure.
	Low oil pressure. Stop the engine. Check the engine oil level, and add more oil if necessary.
NOTICE	
Do not continue to run the engine if this indicator is on. Serious engine damage will occur.	
	Engine overheating. Stop the engine immediately. Check the cooling water inlet, and clear it if it is blocked.
NOTICE	
Do not continue to run the engine if this indicator is on. Serious engine damage will occur.	
	Low battery voltage. Check the battery and battery connections, and tighten all loose battery connections. Return to port soon if tightening the battery connections does not increase the battery voltage. Consult your Yamaha dealer immediately. Do NOT stop the engine when this alert is on. If you do, you may not be able to restart the engine.
	Water in the fuel. Water has collected in the fuel filter (fuel separator). Stop the engine immediately and consult the engine manual to drain the water from the fuel filter. Gasoline mixed with water might cause damage to the engine.
	Check engine/maintenance alert. There is an issue with the combustion engine. Consult your Yamaha dealer immediately. The check engine alert also appears when more than 100 hours have elapsed since the previous maintenance.
	Check motor/maintenance alert. There is an issue with the electric motor. Consult your Yamaha dealer immediately.
	Engine alert notification. (Helm Master®)
	Engine emission issue.

Setting Up the Gauges

Configuring the Number of Engines

- 1 From a gauges screen, select **••• > Num. Engines**.
- 2 Select the number of engines.

Configuring the Tank Level Sensors

- 1 From a gauges screen, select **••• > Tank Preset**.
- 2 Select a tank level sensor to configure.
- 3 Select **Name**, enter a name, and select **Done**.

- 4 Select **Type**, and select the type of sensor.
- 5 Select **Style**, and select the style of sensor.
- 6 Select **Tank Capacity**, enter the capacity of the tank, and select **Done**.
- 7 Select **Calibration**, and follow the on-screen instructions to calibrate the tank levels.
If you do not calibrate the tank levels, the system uses default settings for the tank levels.

Changing the Data Shown

- 1 From a data screen, hold a customizable item.
- 2 Select a data type.
- 3 Select the data to display.

Yamaha® Engine Data Settings

NOTICE

Be sure the settings are set correctly. If not, the engine screen will not display the correct information.

From a Yamaha engine screen, select •••.

Trip: Displays information about the trip, such as distance and hours, and allows you to reset these values.

Maintenance Reminder: Displays maintenance information, enables you to set the maintenance intervals, and allows you to reset the time elapsed since the previous maintenance.

Tank Preset: Sets the tank name, fluid type, sensor style, and tank capacity, and calibrates the sensor.

Trim Assist: Turns the trim assist feature on or off. Available on the Helm Master® system equipped with a digital engine control (DEC) system.

Steer Friction: Sets the friction on the steering wheel. The friction adjusts automatically according to the engine speed. Available on the Helm Master system equipped with a digital engine control (DEC) system.

Lock to Lock: Sets the number of times the steering wheel can be turned between locks, fully to port and fully to starboard.

Speed Control: Sets the speed source to GPS or RPM. Using GPS as the Speed Source is available only with the Helm Master EX system equipped with an autopilot or joystick. GPS is not available on the Helm Master system.

Speed Control > Wave Assist: Turns on the Wave Assist feature for applicable systems.

Speed Control > Wave Assist Level: Sets the sensitivity level for the Wave Assist feature. The higher you set the level, the more the system reacts to wave height and distances when adjusting the speed automatically.

Autopilot Setting: Configures the Yamaha autopilot settings. Available on the Helm Master EX system equipped with an autopilot. For Garmin® autopilot information, see ([Autopilot, page 89](#)).

Joystick and Set Point: Sets the joystick thrust, trim angle and preset, fine tuning distance, and fish point settings. Available on the Helm Master system and the Helm Master EX system equipped with a joystick.

Trim Assist Preset: Sets up the trim assist presets. Available on the Helm Master system equipped with a digital engine control (DEC) system.

Fuel Flow Offset: Sets the offset for the fuel flow data.

Off Timer: Turns off the system one hour after the engine is turned off.

Battery Management: Configures the battery management system, such as setting the type and capacity of the batteries. Also displays the battery status. Available on Helm Master EX systems equipped with Battery Management System (BMS).

Calibration: Calibrates various features, such as the Trim Zero Set and compass.

Reset: Resets the engine and gateway data.

Mercury® Engine Gauges

NOTE: This feature is available only when connected to the Mercury SmartCraft Connect gateway. The available data varies based on the engine network and may include RPM, engine hours, coolant pressure, oil pressure, and other data.

Select **Gauges > Mercury** to view the Mercury engine gauges.

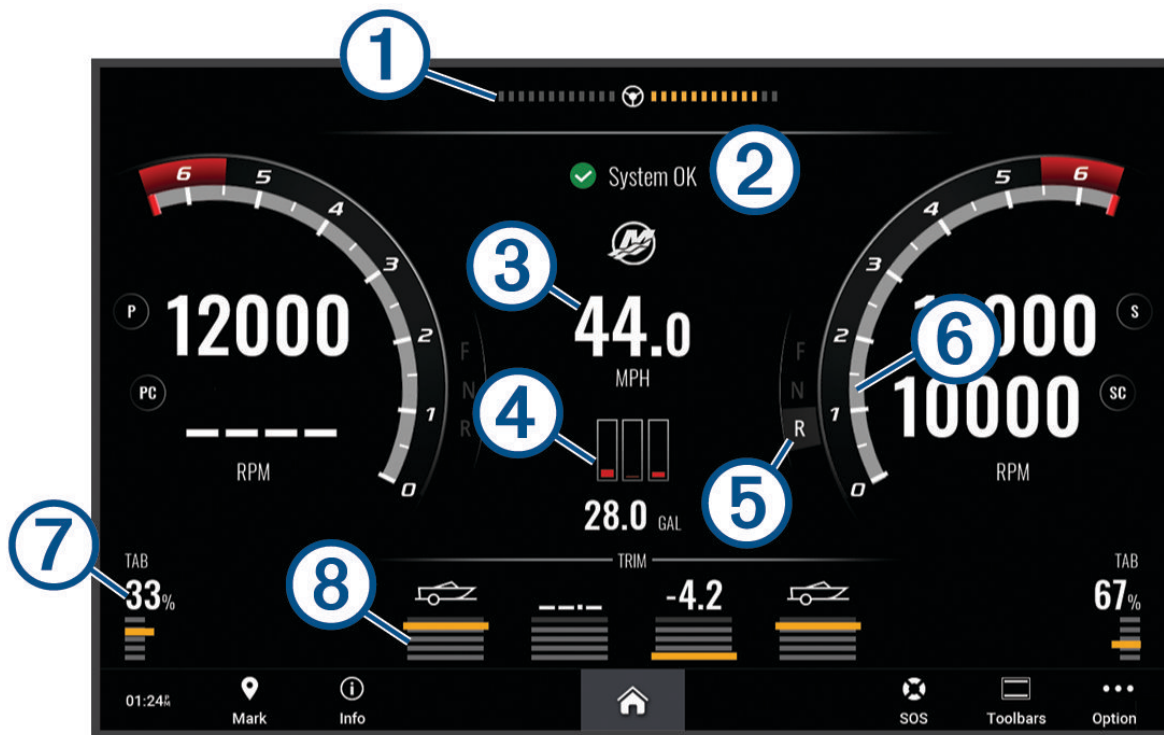

①	Engine voltage or Mercury Steering Angle ²
②	Boat status
③	Boat speed
④	Fuel
⑤	Transmission gear
⑥	Engine speed
⑦	Trim tabs
⑧	Engine trim

TIP: To view additional engine details, select **⋮ > Engine Data**.

Setting the Fuel Alarm

⚠ CAUTION

The Beeper setting must be turned on to make alarms audible ([Sounds and Display Settings, page 152](#)). Failure to set audible alarms could lead to injury or property damage.

Before you can set a fuel level alarm, you must connect a compatible fuel flow sensor to the chartplotter. You can set an alarm to sound when the total amount of remaining onboard fuel reaches the level you specify.

- 1 Select **⚙ > Alarms > Fuel > Total Fuel Onboard > On**.
- 2 Enter the remaining amount of fuel that triggers the alarm, and select **Done**.

Synchronizing the Fuel Data with the Actual Vessel Fuel

If you are using fuel flow sensors, you must synchronize the fuel levels in the chartplotter with the actual fuel in the vessel when you add fuel to your vessel. If you are using fuel tank sensors, the level is adjusted automatically based on the tank level sensor data and it is not necessary to synchronize fuel levels manually ([Fuel Settings, page 159](#)).

² The Mercury Steering Angle may appear on the display, depending on the engine model and configuration, and its location on the display may vary.

- 1 Select **Gauges**.
- 2 Select **Engines** or **Fuel**.
- 3 Select **...**.
- 4 Select an option:
 - If you have filled up all the fuel tanks on the vessel, select **Fill Up All Tanks**. The fuel level is set to maximum capacity.
 - If you have added less than a full tank of fuel, select **Add Fuel to Boat**, and enter the amount added.
 - To specify the total fuel in the vessel tanks, select **Set Total Fuel Onboard**, and enter the total amount of fuel in the tanks.

Viewing the Wind Gauges

Before you can view wind information, you must have a wind sensor connected to the chartplotter.

Select **Gauges > Wind**.

Configuring the Sailing Wind Gauge

You can configure the sailing wind gauge to show true or apparent wind speed and angle.

- 1 From the wind gauge, select **...** > **Edit Gauge Pages**.
- 2 In the window on the left, select the **Sailing Wind Gauge**.
- 3 Select an option:
 - To show true or apparent wind angle, select **Needle**, and select an option.
 - To show true or apparent wind speed, select **Wind Speed**, and select an option.

Configuring the Speed Source

You can specify whether the vessel speed data displayed on the gauge and used for wind calculations is based on water speed or GPS speed.

- 1 From the wind gauge, select **...** > **Edit Gauge Pages**.
- 2 In the window on the left, select **Compass Gauge**.
- 3 Select **Speed Display**, and select an option:
 - To calculate the vessel speed based on data from the water-speed sensor, select **Water**.
 - To calculate the vessel speed based on GPS data, select **Satellite Positioning**.

Configuring the Heading Source of the Wind Gauge

You can specify the source of the heading displayed on the wind gauge. Magnetic heading is the heading data received from a heading sensor, and GPS heading is calculated by your chartplotter GPS (course over ground).

- 1 From the wind gauge, select **...** > **Edit Gauge Pages**.
- 2 In the window on the left, select **Compass Gauge**.
- 3 Select **Heading Source**, and select an option:
 - To use heading data received from a heading sensor, select **Magnetic**.
 - To use heading data calculated using GPS, select **GPS**.

When moving at low speeds or when stationary, the magnetic compass source is more accurate than the GPS source.

Customizing the Close-Hauled Wind Gauge

You can specify the range of the close-hauled wind gauge for both the upwind scale and the downwind scale.

- 1 From the wind gauge, select **...** > **Edit Gauge Pages**.
- 2 In the window on the left, select **Compass Gauge** or **Sailing Wind Gauge**.
- 3 Select **Replace Data > Sailing > Close Hauled Gauge**.
The Compass Gauge or Sailing Wind Gauge is replaced by the Close Hauled Gauge.
- 4 Select an option:
 - To set the maximum and minimum values that appear when the upwind close-hauled wind gauge appears, select **Change Upwind Scale**, and set the angles.
 - To set the maximum and minimum values that appear when the downwind close-hauled wind gauge appears, select **Change Downwind Scale**, and set the angles.
 - To view true or apparent wind, select **Wind**, and select an option.

Viewing Trip Gauges

Trip gauges show information for odometer, speed, time, and fuel for your present trip.

Select **Gauges > Trip**.

Resetting Trip Gauges

- 1 Select **⋮**.
- 2 Select an option:
 - To set all the readings for the present trip to zero, select **Reset Trip**.
 - To set the maximum speed reading to zero, select **Reset Maximum Speed**.
 - To set the odometer reading to zero, select **Reset Odometer**.
 - To set all the readings to zero, select **Reset All**.

Viewing Graphs

Before you can view graphs of various environmental changes, such as temperature, depth, and wind, you must have an appropriate transducer or sensor connected to the network.

You can view graphs of sensor data by creating a new Combo page or by adding a graph to an existing Combo page.

- 1 Create a new **Combo** page or open an existing **Combo** page ([Creating a New Combination Page, page 17](#)).
- 2 Select the window where you want to add a graph, and select **Graphs**.
- 3 Select the graph you want to add.

TIP: You can change the graph in an active combo window by selecting **⋮ > Change Graph**, and selecting a new graph.

Setting the Graph Range and Time Scales

You can indicate the amount of time and the range of sensor data that appears in the depth, wind, and water temperature graphs.

- 1 Select a graph in a **Combo** page, and select **⋮**.
- 2 Select an option:
 - To set a time-elapsed scale, select **Duration**. The default setting is 10 minutes. Increasing the time-elapsed scale allows you to view variations over a longer period of time. Decreasing the time-elapsed scale allows you to view more detail over a shorter period of time.
 - To set the graph scale, select **Scale**. Increasing the scale allows you to view more variation in readings. Decreasing the scale allows you to view more detail in the variation.

Disabling Graph Filtering

The wind speed and wind angle graph filtering smooths out sensor data before it is displayed on a graph. The default setting is On. You can disable the filtering.

- 1 Select a graph in a **Combo** page, and select **⋮**.
- 2 Select **Filter > Off**.

Garmin OnBoard™ Man Overboard Engine Cutoff System

⚠ CAUTION

For the best possible performance and to avoid potential injury, damage to the device, or damage to your vessel, installation by a qualified marine installer is recommended.

NOTICE

The following instructions apply to the Garmin OnBoard system only. If you have a Yamaha® vessel with a Wireless Station and MOB tags, refer to the instructions provided with your Yamaha Wireless Station manual when using and configuring your Yamaha MOB tags.

If you have installed a Garmin OnBoard man overboard Engine Cutoff System (ECOS) on your boat, you can use the chartplotter to interact with and customize the system.

You must install and test the Garmin OnBoard engine cutoff system before using it on your vessel. Follow the *Garmin OnBoard Engine Cutoff System Installation Instructions* provided in the product box to install and test the system.

MOB Tag

⚠ CAUTION

Users should wear the MOB tag in a location that would likely be submerged during a man overboard event, such as on the wrist, belt, or lower part of a life jacket. The system may not activate as expected if the MOB tag is worn in a different location that may not become submerged, such as on the shoulder.



One MOB tag must be worn by the captain when piloting the vessel. Additional tags may be purchased and assigned as additional Captain tags or as Passenger tags. These roles determine the behavior of the system when a tag is out of range.

NOTE: You can connect up to eight total tags to the Garmin OnBoard™ engine cutoff system, and at least one tag must be assigned the Captain role.

①	<p>Power and interface button:</p> <ul style="list-style-type: none">• If the tag is not connected to the Garmin OnBoard system, hold for two seconds to turn the tag on and off.• If the tag is connected to the Garmin OnBoard system:<ul style="list-style-type: none">• Hold for 2 seconds or longer to change the tag status from protected to disarmed and back to protected.• Press to show the status and battery level. The shield and battery icon LEDs flash different colors (Checking the Status of an MOB Tag, page 115).• Hold for four seconds or longer to turn the tag on and off.
②	<p>MOB button:</p> <p>Press to initiate a Man Overboard (MOB) function (Initiating an MOB Procedure from an MOB Tag Manually, page 116).</p> <p>On a tag with the Captain role, you can hold this for two seconds or longer to initiate a MOB function that also kills the engine or engines.</p>
🛡	<p>Status indicator. When you press the power button, the LED color indicates the status of the tag (Checking the Status of an MOB Tag, page 115).</p>
🔋	<p>Battery-level indicator. When you press the power button, the LED color indicates the battery status of the tag (Checking the Status of an MOB Tag, page 115).</p>

Attaching the Band or Carabiner Loop

The MOB tag is packaged with a carabiner loop, a wristband, and a floating keytag. You can use the carabiner loop to attach the MOB tag to your clothing, or you can attach the MOB tag to the wristband to wear it on your wrist. You can also attach the floating keytag to the carabiner or to the wristband to prevent the MOB tag from sinking if it is accidentally lost in the water. Follow these steps to attach the wristband or the carabiner loop to the MOB tag.

- 1 Insert one end of the spring bar on the band or carabiner loop into one of the holes on the MOB tag.

- 2 Slide the quick-release pin to retract the other end of the spring pin.
- 3 Align the spring bar with the other hole in the MOB tag, and release the pin.



MOB Tag Roles

You can connect multiple MOB tags to the Garmin OnBoard™ engine cutoff system and assign different roles to the tags, depending on who is wearing it. For details on the exact actions performed by each role, see ([MOB Tag Behavior, page 114](#)).

Captain: This role is intended for an MOB tag worn by a vessel captain or an individual responsible for controlling the vessel. A tag with a Captain role allows the system to shut off the engine or engines during a Man Overboard (MOB) event.

NOTICE

At least one MOB tag with the Captain role assigned must be paired for the Garmin OnBoard engine cutoff system to function. You cannot change the role of a Captain tag if it is the only tag paired with the Captain role assigned.

Passenger: This role is intended for an MOB tag worn by a passenger on the vessel. A tag with a Passenger role allows the system to create alerts during a MOB event, but it does not allow the system to shut off the engines.

⚠ CAUTION

When a tag with a Passenger role disconnects, the system does not shut off the engines. The system shuts off the engines only when all Captain tags are disconnected.

MOB Tag Behavior

When a protected MOB tag disconnects from the Garmin OnBoard™ engine cutoff system by traveling out of range of the GOS™ 10 hub, the Garmin OnBoard system considers this to be a man-overboard event. Based on the role assigned to the tag, the performs these actions in this general order.

Action	Captain Role	Passenger Role
A message banner appears on all connected chartplotters indicating that the connection with the tag has been lost. The alarm buzzer connected to the GOS 10 hub sounds a loud alert.	✓	✓
A three-second countdown timer appears on all connected chartplotters. NOTE: You can cancel the timer and alert if the man-overboard event was an error. If the countdown timer is not canceled, after three seconds, the system: <ul style="list-style-type: none"> • cuts off power to the engines to stop the vessel • creates a Man Overboard (MOB) waypoint on the chartplotter at the location where the signal from the MOB tag was lost • displays a message stating Engine Cutoff Initiated 	✓	✗
NOTICE		
If more than one MOB tag connected to the system are assigned the Captain role, all of the Captain tags must disconnect before the system kills the engines and triggers an MOB action.		
A fifteen-second countdown timer appears on all connected chartplotters. NOTE: You can cancel the timer and alert if the man-overboard event was an error. If the countdown timer is not canceled, after fifteen seconds the system creates a Man Overboard (MOB) waypoint on the chartplotter at the location where the signal was lost. The engines remain functional.	✗	✓
⚠ CAUTION		
When a tag with a Passenger role disconnects, the system does not shut off the engines. The system shuts off the engines only when all Captain tags are disconnected.		





Action	Captain Role	Passenger Role
You are prompted to begin navigation to the MOB waypoint. If a compatible autopilot system is connected to the network, you can initiate a route to the waypoint from this message.		
NOTICE	✓	✓
For an MOB tag with a Captain role, you must acknowledge the Engine Cutoff Initiated message on a chartplotter before power is restored to the engines and you can begin navigating again.		
An SOS script appears that can be used to make a VHF distress call. From this view, you can also see the location of the MOB waypoint on the chart and dismiss it if necessary.		
⚠ CAUTION	✓	✓
The Garmin OnBoard system does not contact emergency services at any time. You must initiate a distress call if needed.		

Turning an MOB Tag On and Off

When you are not using the tag, you can turn it off to preserve battery life.

NOTICE



You must turn on an MOB tag before it can communicate with the GOS™ 10 hub.



- 1 If the MOB tag is off, hold the power button on the side of the tag for at least two seconds.
The  and  icons flash green twice to indicate that the MOB tag is now on.
- 2 If the MOB tag is on, hold the power button on the side of the tag for at least 4 seconds.
The  and  icons flash red twice to indicate that the MOB tag is now off.

Checking the Status of an MOB Tag

Press and release the power button on the side of the MOB tag.

NOTE: You should not hold the power button when checking the status of the tag, as this turns off the tag. Only press and release it to view status information.

The  and  icons blink a color to indicate the status of the tag.

	Green	Connected and protected
	Yellow	Connected, not protected
	Red	Not connected
	White flash	Appears after the status color to indicate that the tag is assigned a Captain role.
	Green	The battery is full or mostly full
	Yellow	The battery is getting low and should be replaced soon
	Red	The battery is critically low and should be replaced immediately

Disarming an MOB Tag

By default, when you turn on an MOB tag within range of the GOS™ 10 hub, it connects to the system in a protected status. When a tag is in a protected status, it triggers an action based on its assigned role when it loses communication with the GOS 10 hub.

On occasion, you may want to leave the vessel or otherwise keep a connected tag from triggering an event. To do this, you can disarm a tag. A disarmed tag remains connected to the GOS 10 hub when in range, but it does not trigger an action when it travels out of range or otherwise becomes disconnected.

By default, when you disarm an MOB tag, the system will attempt to protect it again after 15 minutes. If the tag is out-of-range of the GOS 10 hub when this time elapses, it becomes protected the next time it connects. You cannot change this default reacquisition time, although you can adjust an individual instance after you have disarmed a tag ([Changing the Reacquisition Time for an MOB Tag, page 118](#)).

- 1 If necessary, turn on the MOB tag you want to change.
- 2 Hold the power button on the side of the MOB tag for two seconds.
 flashes yellow to indicate that the MOB tag is disarmed.
- 3 To change the status of a tag to protected again, you can repeat the previous step.

♥ flashes green to indicate that the MOB tag is protected again.

TIP: You can also disarm connected MOB tags using the chartplotter ([Configuration, page 116](#)).

Initiating an MOB Procedure from an MOB Tag Manually

If a passenger falls overboard who is not wearing an MOB tag, or if you want to initiate a Man Overboard (MOB) procedure without waiting for a tag to become out of range of the GOS™ 10 hub, you can manually trigger the effect directly from any MOB tag connected to the Garmin OnBoard™ engine cutoff system.

Press the large MOB button on the face of a connected MOB tag.

On a tag with the Captain role, you can hold the MOB button for at least two seconds to initiate a MOB function that also kills the engine or engines.

The Garmin OnBoard system creates a Man Overboard (MOB) waypoint on the chartplotter at the location where the button was pressed and prompts you begin navigating to the waypoint. An SOS script appears that can be used to make a VHF distress call, and you see the location of the MOB waypoint on the chart and dismiss it if necessary.

Replacing the MOB Tag Battery

⚠ WARNING

See the *Important Safety and Product Information* guide in the product box for product warnings and other important information.

NOTICE

The MOB tag uses a CR2032 3V coin-cell battery. You must install a new CR2032 3V coin-cell battery as a replacement. Using any other type of battery is not supported.

You should purchase a replacement battery only from a high-quality manufacturer and a reputable vendor. Using a low-quality battery could result in poor product performance and reduced battery life, especially at low temperatures. Do not use rechargeable batteries. Rechargeable batteries may have a higher voltage specification and can cause permanent damage to the device.

- 1 Using a #1 Phillips screwdriver, loosen the four captive screws to remove the back cover.
- 2 Gently lift the white tab to release the battery from the back cover.
- 3 Place the new battery in the back cover, with the positive (+) side down.
- 4 Make sure the rubber gasket in the front cover of the MOB tag is not broken and is fully seated in its groove.

The gasket fits in the groove in a specific orientation.

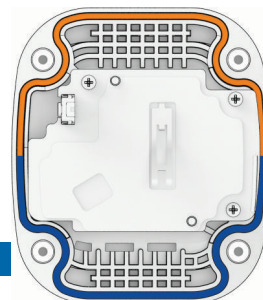

NOTICE

If the gasket is not properly and fully seated in the groove, it does not create a seal, which leads to the failure of the MOB tag when it is exposed to water. Contact Garmin® product support for information on purchasing a replacement gasket.

After you replace the battery, you may need to pair the MOB tag again ([Pairing an MOB Tag, page 117](#)).

Configuration

To configure the Garmin OnBoard™ engine cutoff system and MOB tags, on a connected chartplotter select **⚙ > Communications > Wireless Devices > OnBoard MOB System > MOB Tags**, then select the name of a tag if necessary.

Role: Changes the role of an MOB tag.

NOTE: The Garmin OnBoard engine cutoff system must have at least one paired tag with the Captain role assigned. To change the role of an existing tag from Captain to Passenger, there must be more than one paired tag with the Captain role.

Rename: Changes the name assigned to a tag for easier identification. Changing the name does not change the role.

Review: Shows the status and other information about a tag.

Review > Remove Device: Unpairs and removes a tag from the Garmin OnBoard engine cutoff system.

Turn Off: Turns off a tag.

Protect: Changes the protection status of a tag. Protected tags trigger actions when leaving range of the hub, disarmed tags do not trigger actions. Tags are protected by default, and can be disarmed for a set period of time before automatically becoming protected again ([Disarming an MOB Tag, page 115](#)).

Reacquire In: Available only when a tag is disarmed. Temporarily changes the time for when a disarmed tag automatically becomes protected again. If the tag is out-of-range when this time elapses, it will become protected again as soon as it is in range and connects to the hub.

New Connection: Begins the pairing process on the hub to connect a new MOB tag.

Adding the MOB Tags Overlay

When connected to a GOS™ 10 hub, you can add an overlay on the chartplotter to control MOB tag functions.

1 From the page where you want to add the overlay, select **☰ > Edit Overlays**.

TIP: You can also select  from the menu bar to quickly change the overlays.



2 Select **Top Bar, Bottom Bar, Left Bar, or Right Bar**.

3 Select **MOB Tags > Back**.

MOB Tags Overlay

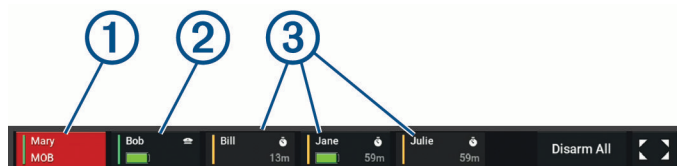
When connected to a GOS™ 10 hub, you can add an overlay on the chartplotter to control MOB tag functions.



①	Protected Passenger tag in Man Overboard (MOB) status: <ul style="list-style-type: none"> The green line on the left indicates that the tag is protected. The red shading and "MOB" text indicates that the tag has left the range of the hub and is now in an active MOB status (MOB Tag Behavior, page 114).
②	Protected Captain tag: <ul style="list-style-type: none"> The green line on the left indicates that the tag is protected.  indicates that this is a captain tag.
③	Disarmed Passenger tags: <ul style="list-style-type: none"> The yellow line on the left indicates that the tag is disarmed. The  and time indicate when the system will attempt to protect the tag again automatically.
Disarm All	Sets all connected tags to the Disarmed status.
	Opens the full-screen MOB tag page.

Pairing an MOB Tag

When you purchase a Garmin OnBoard™ engine cutoff system, the MOB tag packaged with the system is already paired with the GOS™ 10 hub and is ready to use. If you purchase additional tags you must pair them with the GOS 10 hub.

1 If necessary, turn on the Garmin® devices on the vessel, including the GOS 10 hub and any connected chartplotters.

2 Hold the power button on the side of the MOB tag for more than two seconds to turn it on.

 on the MOB tag flashes red to indicate that the tag is not connected to the GOS 10 hub.

3 On a connected chartplotter, select **⚙ > Communications > Wireless Devices > OnBoard MOB System > MOB Tags > New Connection**.

TIP: If it is accessible, you can press the button on the GOS 10 hub three times to start the pairing process. The LED on the GOS 10 hub flashes blue to indicate that it is in pairing mode.

4 On the MOB tag, press the power button on the side three times.

 on the MOB tag flashes blue to indicate that it is in pairing mode.

A message is shown on the connected chartplotter screen, indicating a pairing request from the MOB tag to the GOS 10 hub.

5 On the connected chartplotter, confirm the pairing request to complete the pairing process.

If this is the first MOB tag to be paired with the GOS 10 hub, it is assigned the Captain role by default. All additional MOB tags paired to the GOS 10 hub are assigned the Passenger role by default.

Changing the Role of an MOB Tag

NOTE: At least one MOB tag with the Captain role assigned must be paired for the Garmin OnBoard™ engine cutoff system to function. You cannot change the role of a Captain tag if it is the only tag paired with the Captain role assigned.

- 1 On a connected chartplotter, select  > **Communications** > **Wireless Devices** > **OnBoard MOB System** > **MOB Tags**.
- 2 Select the MOB tag you want to change.
- 3 Select **Role**.
- 4 Select the role you want to assign to the MOB tag.

Changing the Name of an MOB Tag

- 1 On a connected chartplotter, select  > **Communications** > **Wireless Devices** > **OnBoard MOB System** > **MOB Tags**.
- 2 Select the MOB tag you want to change.
- 3 Select **Rename**.
- 4 Enter a new name for the MOB tag.

Changing the Reacquisition Time for an MOB Tag

By default, when you disarm an MOB tag, the system attempts to protect it again after 15 minutes. You can temporarily extend the length of time before a disarmed tag becomes protected again automatically. After the disarmed tag becomes protected again, this value resets to the default of 15 minutes for the next time you disarm the tag.

- 1 Disarm an MOB tag.
- 2 On a connected chartplotter, select  > **Communications** > **Wireless Devices** > **OnBoard MOB System** > **MOB Tags**.
- 3 Select the disarmed MOB tag.
- 4 Select **Reacquire In**.
- 5 Select a new value.

The system attempts to protect the disarmed MOB tag again after the newly-specified value elapses. After the disarmed tag becomes protected again, this value resets to the default of 15 minutes for the next time you disarm this tag.

Removing an MOB Tag

If you no longer want to use a paired MOB tag, you can remove it from the system.

NOTE: At least one MOB tag with the Captain role assigned must be paired for the Garmin OnBoard™ engine cutoff system to function. You cannot remove a tag if it is the only tag paired with the Captain role assigned.

- 1 On a connected chartplotter, select  > **Communications** > **Wireless Devices** > **OnBoard MOB System** > **MOB Tags**.
- 2 Select the MOB tag you want to remove.
- 3 Select **Review** > **Remove Device**.

Restoring the Garmin OnBoard™ Engine Cutoff System to Factory Default Settings

NOTICE

When performing a factory reset on the Garmin OnBoard engine cutoff system, the security event log stored on the GOS™ 10 hub is cleared. All personal information, including locations and timestamps, as well as security-event records are deleted.

- 1 Turn on the GOS 10 hub.
- 2 Press the button on the GOS 10 hub five times.

NOTE: Restoring the GOS 10 hub software to factory defaults does not affect any paired MOB tags. Any previously-paired MOB tags retain custom name and role information you may have applied, but are no longer paired to the GOS 10 hub. Each previously-paired MOB tag must be reset individually if you want to clear custom name or role configuration information stored on the tag.

Restoring an MOB Tag to Factory Default Settings

You can perform a procedure to restore an MOB tag to factory default settings, which clears any custom name or role information stored on the tag.

- 1 Turn on the MOB tag you want to restore to factory default settings.
- 2 Disarm the MOB tag (*Disarming an MOB Tag*, page 115).
You cannot restore an MOB tag when it is in a protected status. You must disarm it first.
- 3 On the MOB tag, press the power button on the side five times.
- 4 Repeat this process for any additional MOB tag you want to restore.

System Bypass

The Garmin OnBoard™ engine cutoff system is designed with two methods you can use to bypass the system. These methods allow you disable engine control and restore typical functionality in the case of an emergency.

Bypassing the System From a Chartplotter

One method to bypass the Garmin OnBoard™ engine cutoff system is by using a connected chartplotter.

NOTE: Bypassing the engine cutoff system using the chartplotter is possible only when the system has cut off the engines due to a man overboard event with a Captain tag, or when testing the system. This option is not available during normal operation.

Within 30 seconds after the system has cut off the engines, select one of these options on a connected chartplotter:

- Select **Yes** in the message that reads **Do you want to be able to restart the engine now?**³
- On an MOB screen, select **Disable Cutoff**³.
- Select **⚙️ > Communications > NMEA 2000 Setup > Device List**, select the **GOS 10 Hub**, then select **Review > Engine Cutoff > Disable**.

The Garmin OnBoard engine cutoff system is now disabled, and the engines should be restored to previous functionality.

NOTICE

The system remains disabled until you enable it again or until you turn off the system and turn it back on again. You must enable the system as soon as possible to be compliant with the AYBC A-33 standard.

To restore the Garmin OnBoard engine cutoff system functionality, select **⚙️ > Communications > NMEA 2000 Setup > Device List**, select the GOS 10 Hub, then **Review > Engine Cutoff > Enable**.

Bypassing the System from the GOS™ 10 Hub

If bypassing the Garmin OnBoard™ engine cutoff system using a connected chartplotter does not work as expected, or if you prefer to use a different method, you can bypass the system directly from the GOS 10 hub.

- 1 Disconnect the wiring harness from the GOS 10 hub.

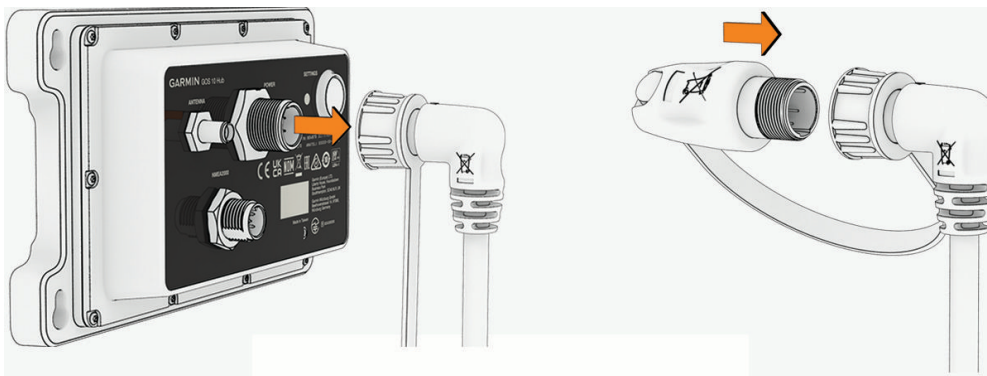

- 2 Connect the bypass module to the wiring harness connector, and tighten the locking ring.
The bypass module should be tethered to the connector end of the wiring harness.
The Garmin OnBoard engine cutoff system is now disabled, and the engines should be restored to previous functionality.

NOTICE

The system remains disabled until you enable it again. You must enable the system as soon as possible to be compliant with the AYBC A-33 standard.

³ This option is available only during a man-overboard event initiated by an MOB tag with the captain role. This message does not appear when testing the system.

To restore the Garmin OnBoard engine cutoff system again, disconnect the bypass module and reconnect the wiring harness to the GOS 10 hub.

inReach® Messages

⚠ WARNING

Do not read or reply to notifications while operating the vessel. Failure to pay attention to the conditions on the water can result in vessel damage, personal injury, or death.

You can connect a compatible inReach satellite communicator to the chartplotter to view, reply to, and send messages from the chartplotter.

NOTICE

The inReach device must be connected to the chartplotter and receiving satellite signals to send and receive messages using the chartplotter.

Before you can use a connected chartplotter to send and receive messages on a compatible inReach device, you must have an active inReach subscription. See the owner's manual for your inReach device for subscription information.

Messages received and sent by the inReach device are grouped as conversations that are identified using the names or addresses of the contacts included in the messages.

All messages are limited to 160 characters, including the name, address, or phone number of the contact or contacts included in the message. If you send a message to larger groups of contacts, this reduces the available characters for the message itself. When composing a message, the available character information is shown in real time on the chartplotter to help avoid exceeding the character limit.

Connecting an inReach® Device to the Chartplotter

You can connect a compatible inReach device to the chartplotter to manage messages.

- 1 Bring the inReach device within 3 m (10 ft.) of the chartplotter.
 - 2 Select an option:
 - On an inReach Mini device, from the main menu, select **Setup > ANT+ > Status > On**.
 - On an inReach Mini 2 device or inReach Messenger, from the main menu, select **Settings > inReach Remote > Status**.
 - On a GPSMAP® 86i or GPSMAP 67i, from the main menu, select **Setup > Sensors > inReach Remote > Enabled > On**.
 - 3 On the chartplotter, select **Vessel > inReach® > Start Pairing**.
The chartplotter begins searching for and connecting to the inReach device. This can take up to 60 seconds.
 - 4 If necessary, compare the code on the inReach device to the chartplotter, and select **OK** if they match.
 - 5 If necessary, select **OK** to agree to any informational messages and complete the connection.
- The inReach and chartplotter connect automatically when they are within range.

Receiving Messages

When your inReach® device receives a message, a pop-up notification appears briefly on the ECHOMAP™ Ultra 2 screen.

- To review the full message, select **View Message**.
- To dismiss the pop-up notification, select **OK** or wait for the notification to close automatically.

Replying to a Message

You can reply to an inReach® message with a pre-written quick message or a custom message.

- 1 From the **inReach®** page, select **Conversations**.
TIP: You can also access inReach conversations from **All Communications > Conversations** in the messages and warnings menu (*Messages and Warnings*, page 135).
- 2 Highlight a conversation, and select **View Conversation**.
- 3 Select an option:
 - To send a quick message, select **Send Quick Message** (*Sending a Quick Message*, page 122).
 - To send a custom message, select **Send Custom Message** (*Sending a Custom Message*, page 122).
- 4 Review the message, and select **Send**.

Sending a Check-In Message

Check-in messages are predefined messages that you prepare for specific contacts using the Garmin Messenger™ app or on your account at explore.garmin.com. You cannot customize the text of check-in messages, only the contacts who will receive it.

- 1 From the **inReach®** page, select **Conversations** > **Send Check-In Message**.

TIP: You can also access inReach® conversations from **All Communications** > **Conversations** in the messages and warnings menu (*Messages and Warnings*, page 135).

- 2 Select a preset or check-in message.
- 3 Select **Send**.

Starting a New Conversation

- 1 From the **inReach®** page, select **Conversations** > **Start Conversation**.

TIP: You can also access inReach® conversations from **All Communications** > **Conversations** in the messages and warnings menu (*Messages and Warnings*, page 135).

- 2 Add recipients:
 - To include an existing contact in the conversation, highlight the contact, and select **Include**.
 - To include a new contact in the conversation, select **Enter New Recipient**, and provide the phone number, email address, or inReach address for the new contact.
- 3 Select an option:
 - To send a quick message, select **Send Quick Message** (*Sending a Quick Message*, page 122).
 - To send a custom message, select **Send Custom Message** (*Sending a Custom Message*, page 122).
- 4 Review the message details, and select **Send**.

Sending a Quick Message

Quick messages are predefined messages that you prepare on your account at explore.garmin.com. Quick messages contain custom text, and are not assigned to a specific contact in your account. They can be used as needed when sending or replying to inReach® messages on the chartplotter.

- 1 From the **inReach®** page, select **Conversations**.

TIP: You can also access inReach conversations from **All Communications** > **Conversations** in the messages and warnings menu (*Messages and Warnings*, page 135).

- 2 Select an existing conversation or start a new conversation (*Starting a New Conversation*, page 122).
- 3 Select **Send Quick Message**, and select the preset message to send.
- 4 Review the message, and select **Send**.

Sending a Custom Message

- 1 From the **inReach®** page, select **Conversations**.

TIP: You can also access inReach® conversations from **All Communications** > **Conversations** in the messages and warnings menu (*Messages and Warnings*, page 135).

- 2 Select an existing conversation or start a new conversation (*Starting a New Conversation*, page 122).
- 3 Select **Send Custom Message**.
- 4 Compose the message, and select **Done**.
- 5 Review the message, and select **Send**.

inReach® SOS Calls

WARNING

Before you can use the SOS function, you must have an active satellite subscription on the connected inReach device. Always test your device before you use it outdoors.

Ensure the inReach device has a clear view of the sky when using the SOS function, because this feature requires satellite access to operate properly.

NOTICE

Some jurisdictions regulate or prohibit the use of satellite communications devices. It is the responsibility of the user to know and follow all applicable laws in the jurisdictions where the device is intended to be used.

When a compatible inReach device is paired to the chartplotter, you can contact the Garmin ResponseSM center to request help. From the chartplotter, you can initiate, cancel, and monitor the status of an inReach SOS call, as well as communicate with the Garmin Response team while you wait for help to arrive.

You should only use the SOS function in a real emergency situation.

Sending an inReach[®] SOS Call

You must pair a compatible inReach device with your chartplotter before you can send an inReach SOS call using the chartplotter.

- 1 From any screen, select **SOS**.
- 2 Select the SOS type.
- 3 Select **Activate inReach SOS**.

The chartplotter initiates an SOS call from the paired inReach device, and creates an entry on the Conversations page. You can communicate with the Garmin ResponseSM team using this conversation.

⚠ CAUTION

When an inReach SOS call is active do not turn off or attempt to turn off the inReach device or connected chartplotter. Doing so could prevent this feature from operating properly and could delay receipt of assistance in the event of an emergency

Communicating with the Garmin ResponseSM Team During an SOS Call

- 1 Send an inReach[®] SOS callxxx.
A new entry for the SOS call appears in the Conversations page. The SOS conversation appears in red text.
- 2 Select the SOS conversation, and select **View Conversation** to view replies from the Garmin Response team.
NOTE: Replies from Garmin Response team also appear as message banners when received by the chartplotter, and you can access new messages from the Warning Manager.
- 3 Select one or more actions:
 - To view the full reply from the Garmin Response team, select the reply, and select **View Message**.
 - To reply to the Garmin Response team, select **Send Quick Message** or **Send Custom Message**.
 - To send information about your vessel to the Garmin Response team, select **Send Vessel Data**.

Cancelling an inReach[®] SOS Call

You can cancel an inReach SOS call you sent using the chartplotter.

- 1 From the **inReach[®]** page, select **Conversations**.
TIP: You can also access inReach conversations from **All Communications > Conversations** in the messages and warnings menu (*Messages and Warnings*, page 135).
- 2 Select the SOS conversation you want to cancel.
- 3 Select **Cancel SOS**, and confirm that you want to cancel the SOS call.

Changing inReach[®] Tracking Settings

You can change the tracking settings on a connected, compatible inReach device. See the owner's manual for your inReach device for more information about the tracking feature.

NOTE: The tracking feature is not available on all inReach models.

- 1 From the **inReach[®]** page, select **Tracking**.
- 2 To turn on tracking, select **Tracking**.
- 3 To adjust the frequency at which the device records a track point and transmits it over the satellite network, select **Send Interval**, and select a value.

The tracking settings are automatically updated on the connected, compatible inReach device.

Digital Switching

Your chartplotter can be used to monitor and control circuits when connected to a compatible digital switching system.

For example, you can control the interior lights and navigation lights on the vessel. You can also monitor live well circuits.

For more information about purchasing and configuring a digital switching system, contact your Garmin® dealer.

Adding and Editing a Digital Switching Page

You can add and customize digital switching pages on the chartplotter.

- 1 Select **Vessel > Switching > ... > Setup**.
- 2 Select **Add Page** or **Edit Page**.
- 3 Set up the page as needed:
 - To enter a name for the page, select **Name**.
 - To set up the switches, select **Edit Switches**.
 - To add an image of the boat, select **Add BoatView Image**.

NOTE: You can use the default vessel image or use a custom image of your vessel. You should save the custom image to the /Garmin folder on the memory card. You can also adjust the view and placement of the image.

Garmin Boat Switch™

WARNING

Garmin® strongly recommends using a professional installer with proper knowledge of electrical systems to install the device. Incorrectly installing the device can result in serious bodily injury and damage to the vessel or the battery.

Configuring the Garmin Boat Switch™ Device

Some digital switches controlled by the Garmin Boat Switch device must be configured before use.

Configuring a Switch as Momentary

All latching and momentary channels on the Garmin Boat Switch™ device must be configured in the chartplotter software as momentary switches for proper operation.

- 1 From a Garmin® chartplotter connected to the same NMEA 2000® network as the Garmin Boat Switch device, select  > **My Vessel > Switching > NMEA Standard**.
- 2 Select the switch number.
- 3 Select **Configuration > Momentary**.

Naming a Switch

You can provide a custom name to be used instead of the default name for each switch.

- 1 From a Garmin® chartplotter connected to the same NMEA 2000® network as the Garmin Boat Switch™ device, select  > **My Vessel > Switching > NMEA Standard**.
- 2 Select the switch number.
- 3 Select **Name > Change Name**.
- 4 Enter a new name.
- 5 Select **Done**.

Labeling a Switch

You can provide a custom label for each switch. The switch label is separate from the switch name.

- 1 From a Garmin® chartplotter connected to the same NMEA 2000® network as the Garmin Boat Switch™ device, select  > **My Vessel > Switching > NMEA Standard**.
- 2 Select the switch number.
- 3 Select **Label > Edit Label**.
- 4 Enter a new label.
- 5 Select **Done**.

Showing and Hiding Switches

You can select which switches are hidden or displayed on the Garmin® chartplotter.

- 1 From a Garmin chartplotter connected to the same NMEA 2000® network as the Garmin Boat Switch™ device, select **⚙️ > My Vessel > Switching > NMEA Standard**.
- 2 Select the switch number.
- 3 Select **Visibility** to show or hide the switch.

Configuring the Navigation Light Option

NOTICE

It is your responsibility to comply with applicable laws, regulations, and standards related to the use and/or operation of marine navigation lights. Garmin® is not responsible for any fines, penalties, citations, or damages that may be incurred due to any such lack of compliance.

By default, channels 1 and 2 are interlocked for navigation lighting to satisfy the international regulations for preventing collisions at sea. Depending on the lighting specifics of your boat, you may need to configure the Garmin Boat Switch™ device to use the wiring option you that applies to your installation type.

If you do not intend to connect navigation and anchor lights to the device, you can configure channels 1 and 2 to operate independently as normal latching switches.

- 1 From a Garmin chartplotter connected to the same NMEA 2000® network as the Garmin Boat Switch device, select **Vessel > Switching**.
- 2 Press and hold switch 1 for 5 seconds.
Switch 1 starts flashing.
- 3 Press and hold switch 2 for 5 seconds.
The switch stops flashing, and a message confirms the newly selected wiring option.
- 4 Repeat the previous two steps until the device is configured for the wiring option that applies to your installation type.

NOTE: After selecting option C, the next configuration option in the cycle deactivates the interlocks so that channels 1, 2, and 3 operate independently as normal latching switches.

Configuring Digital Switches for Voice Control

Before you can use the voice control feature on the chartplotter to control switched devices using your Garmin Boat Switch™ device, you must assign details about the devices connected to each switch you want to control.

- 1 From a Garmin® chartplotter connected to the same NMEA 2000® network as the Garmin Boat Switch device, select **⚙️ > My Vessel > Switching > Voice Control**.
- 2 Select the switched channel you want to configure for voice control, then select **Select Type**.
- 3 Select the type of device connected to the switched channel, then select **Set Type**.
- 4 If needed, perform any additional configurations for the channel and device:
 - If you have more than one type of device on the boat and you need to add an identifying number (ex. light 1, light 2, etc.), select **Select Identity**, select a number to assign to the device, then select **Set Identity**.
 - If you want to see examples of how you can use voice control for the device, select **Show Examples**.
 - If you made mistakes and want to reset the voice control settings for the device, select **Reset**.

After you have set the type and optional identity information for devices connected to the Garmin Boat Switch device, you can use voice control to interact with them ([Chartplotter Voice Commands, page 21](#)).

Device Types For Voice Control

Because the Garmin Boat Switch™ device is preconfigured for specific device types on certain channels, you can refer to this table to help verify that you are assigning the appropriate details to each channel you want to use with voice control.

Channel ⁴	Device Types
1	<ul style="list-style-type: none"> • Red/green navigation light grouping • Red/green/white light grouping • Generic latching device
2	<ul style="list-style-type: none"> • White/anchor navigation light grouping • Anchor light • Steaming light • Generic latching device

Channel ⁴	Device Types
3	<ul style="list-style-type: none"> Anchor light Generic latching device
4	Generic latching device
5	Generic latching device
9	Generic latching device
10	Generic latching device
11	Live well pump
12	Bilge pump
13	Bilge pump
17	Generic latching device (dimnable)
18	Generic latching device (dimnable)
19	Generic latching device (dimnable)
20	Generic latching device (dimnable)
21	Generic latching device (dimnable)
25	<ul style="list-style-type: none"> Horn Generic momentary device
26	<ul style="list-style-type: none"> Horn Generic momentary device
27	<ul style="list-style-type: none"> Horn Generic momentary device

Using the Bilge Pump Switches

You can manually operate connected bilge pumps by using switches 12 and 13 on the Garmin® chartplotter.

- 1 From a Garmin chartplotter connected to the same NMEA 2000® network as the Garmin Boat Switch™ device, select **Vessel > Switching**.
- 2 Select an option:
 - Press and hold the bilge pump switch for one second to run the bilge pump for 2 minutes.
 - Press and hold the bilge pump switch for three seconds to run the bilge pump continuously.
Your Garmin chartplotter notifies you every 5 minutes while continuous mode is active.

Using Dimmable Lights

You can operate connected dimmable lights by using switches 17 through 21 on the Garmin® chartplotter.

- 1 From a Garmin chartplotter connected to the same NMEA 2000® network as the Garmin Boat Switch™ device, select **Vessel > Switching**.
- 2 Select an option:
 - Press a dimmable light switch to turn a light on or off.
NOTE: The light turns on at the dim level set when the light was last turned off.
 - With a light on, press and hold a dimmable light switch dim the light, and release to stop dimming.
 - With a light off, press and hold a dimmable light switch to turn on the light at 100% brightness.

Controlling Third-Party Equipment Installed on Your Boat

Power-Pole® Anchor System

⚠ WARNING

Do not engage the Power-Pole Anchor System while underway. Doing so could cause result in an accident causing property damage, serious personal injury, or death.

If a compatible Power-Pole anchor system is connected to the NMEA 2000® network, you can use the chartplotter to control the Power-Pole anchor. The chartplotter automatically detects the Power-Pole anchor system's C-Monster® gateway on the NMEA 2000 network.

Enabling the Power-Pole® Anchor or CHARGE™ Overlay

You must enable an overlay on the chartplotter to control the Power-Pole anchor system or a CHARGE power management system on your vessel.

1 From the page to which you will add the overlay, select **••• > Edit Overlays**.

TIP: To quickly select the overlay, select  then Anchor or Charge.

2 Select where you want to add the overlay.

3 Select **Power-Pole® Anchor** or **Power-Pole® Charge**.

After you enable the Power-Pole overlay on the chartplotter, you must set the Power-Pole installation mode to match the Power-Pole anchor installation on the boat ([Setting Up the Power-Pole® Anchor, page 127](#)).

Setting Up the Power-Pole® Anchor

Before you can use the chartplotter to control the Power-Pole anchor, you must select the required installation mode.

The default initial installation mode setting is None. While the installation mode is set to None, the chartplotter control of the Power-Pole anchor(s) is inactive.

1 From the Power-Pole toolbar, select  > **Installation**.

2 Select the installation mode that matches the anchor installation on the boat.

- To control a single port side Power-Pole anchor, select **Port**.
- To control a single starboard side Power-Pole anchor, select **Starboard**.
- To control dual Power-Pole anchors, select **Dual**.







3 Use the slider to set the desired speed for the anchor to deploy and retract.

Power-Pole® Overlay

Before you can control the Power-Pole anchor with the chartplotter, you must enable the overlay ([Enabling the Power-Pole® Anchor or CHARGE™ Overlay, page 127](#)) and set the Power-Pole installation mode ([Setting Up the Power-Pole® Anchor, page 127](#)).

The layout of the overlay varies based on the installation mode. Refer to your Power-Pole documentation for more information.



	Select to control both anchors simultaneously Deselect to control the anchors independently
	Select to fully retract the anchor
	Select to fully extend the anchor
	Hold to retract the anchor manually Release to stop the anchor
	Hold to extend the anchor manually Release to stop the anchor
	Select to open the menu

	Select to enable the advanced boat control feature NOTE: This option is available only when connected to a compatible Garmin® trolling motor
PORT	Port side anchor control buttons
STBD	Starboard side anchor control buttons

Power-Pole® Advanced Boat Control

When the chartplotter is connected to a compatible Garmin® trolling motor and a compatible Power-Pole anchor system, you can enable advanced boat control functions that use both the Power-Pole anchors and the trolling motor.

NOTE: You must enable Anchor Lock on the trolling motor before you can enable advanced boat control.

From the Power-Pole overlay, select  to enable these advanced boat control functions.

NOTE: The first time you enable advanced boat control, you must perform a one-time process to set the max depth and drag sensitivity. These settings can be adjusted later from the menu on the Power-Pole overlay.

Smart Anchor Selection: The system determines when to use the Anchor Lock function on the trolling motor or the Power-Pole anchor system.

Drag Detection: If the Power-Pole shallow water anchors fail to hold the vessel's position, the anchors are stowed automatically, the trolling motor attempts to return the vessel to the original position, and it redeploys the anchors.

Anchor Jog: When using the trolling motor to move to a different anchor location, the system automatically stows the anchors if necessary until the jog procedure is complete. The system then determines whether to redeploy the anchors or use the trolling motor Anchor Lock function depending on the depth.

Trolling Motor Direction Control: When the Power-Pole anchors are deployed, you can rotate the angle of the trolling motor as needed. This is helpful when you are using LiveScope™ on the trolling motor and you want to view a different angle while anchored.

Auto-Stow: The system automatically stows Power-Pole anchors when you stow the trolling motor.

If you want to continue using the Power-Pole anchors when stowing the trolling motor, you must disable advanced boat control from the Power-Pole overlay.





CHARGE™ Overlay

Before you can add the CHARGE overlay, you must install a CHARGE power management system on your vessel and connect it to a C-Monster® control system. Both of these systems are Power-Pole® products and not produced by Garmin®. After installing this hardware, you must configure the CHARGE power management system and the C-Monster control system so the chartplotter can access and control the charge functions. See the owner's manual provided with your CHARGE power management system for more information.

After installing and configuring the CHARGE power management system, you can enable the CHARGE overlay to control the system using the chartplotter ([Enabling the Power-Pole® Anchor or CHARGE™ Overlay, page 127](#)).

The layout of the overlay varies based on the size of the chartplotter model. Smaller models may show less text, but the functions are the same.



	Engine battery status.
	CHARGE priority setting. You can select an icon to quickly adjust the priority between the engine and the auxiliary batteries. The color of the bar indicates the battery-charging status. When a battery is being charged, the bar near that battery appears green. When a battery is not receiving a charge, the bar near that battery appears gray.
	Auxiliary battery status.
	Indicates that a battery is charging.
	Indicates that a battery either is not charging or is being discharged into the other battery.

	Indicates that the CHARGE power management system is connected to shore power.
Emergency Transfer	Select to start an emergency transfer of power from the auxiliary battery or batteries to the engine battery.

Mercury® Troll Control Features

WARNING

You are responsible for the safe and prudent operation of your vessel. The Mercury troll control features do not steer the boat for you and do not avoid navigational hazards. Failure to safely operate your boat could result in an accident causing property damage, serious personal injury, or death.

When connected to a compatible Mercury engine, you can use the Mercury Troll overlay to set and adjust the trolling speed from the chartplotter.

Adding the Mercury® Troll Control Overlay

When connected to a compatible Mercury engine, you can set and adjust the target speed using the Mercury Troll overlay on the chartplotter.

1 From the page where you want to add the overlay, select **••• > Edit Overlays**.

TIP: You can also select  from the menu bar to quickly change the overlays.

2 Select **Top Bar, Bottom Bar, Left Bar, or Right Bar**.



3 Select **Mercury Troll**.

4 Select **Back**.

Mercury® Troll Overlay

When connected to a compatible Mercury engine, you can use the Mercury Troll overlay on the chartplotter to set a target speed.



	Select to decrease the target speed
①	Target speed
	Select to increase the target speed
②	Actual speed
Enable	Select to engage the Mercury Troll feature
Disable	Select to disengage the Mercury Troll feature

Mercury® Cruise Control

WARNING

You are responsible for the safe and prudent operation of your vessel. Mercury Cruise Control does not steer the boat for you and does not avoid navigational hazards. Failure to safely operate your boat could result in an accident causing property damage, serious personal injury, or death.

When connected to a compatible Mercury engine, you can set and adjust the cruise-control function using the chartplotter.

Enabling the Mercury® Cruise Control Overlay

1 From the page where you want to add the overlay, select **••• > Edit Overlays**.

TIP: You can also select  from the menu bar to quickly change the overlays.

2 Select **Top Bar, Bottom Bar, Left Bar, or Right Bar**.

3 Select **Mercury Cruise**.

4 Select **Back**.

Mercury® Cruise Control Overlay



—	Select to decrease the target speed
①	Target speed
+	Select to increase the target speed
②	Actual speed
Enable	Select to engage the cruise control
Disable	Select to disengage the cruise control

Mercury® Engine Details

⚠ WARNING

You are responsible for the maintenance of the engines on your vessel. Failure to properly maintain the engines could result in an accident causing property damage, serious personal injury, or death.

When your chartplotter is connected to a compatible Mercury engine, you can view engine data using the Mercury Engine overlay on the chartplotter.

Adding the Mercury® Engine Overlay

- 1 From the page where you want to add the overlay, select **••• > Edit Overlays**.
TIP: You can also select  from the menu bar to quickly change the overlays.
- 2 Select **Top Bar, Bottom Bar, Left Bar, or Right Bar**.
- 3 Select **Mercury Engine**.
- 4 Select **Back**.

Mercury® Engine Overlay

You can use the Mercury Engine Overlay to view engine data ([Adding the Mercury® Engine Overlay, page 130](#)). Due to space constraints on the overlay, some items may not appear if the vessel has multiple engines.

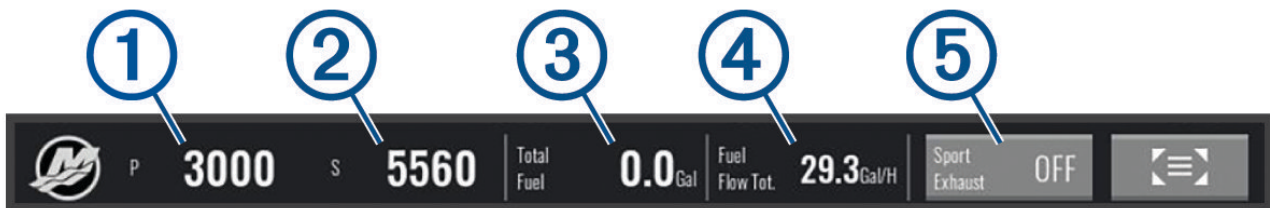

①	Port engine RPM
②	Starboard engine RPM
③	Total available fuel
④	Fuel usage
⑤	Sport Exhaust control (if supported) (Enabling the Mercury® Engine Sport Exhaust Setting, page 131)

TIP: You can also view an overview of engine details on the Mercury gauges page ([Mercury® Engine Gauges, page 109](#)).

Enabling the Mercury® Engine Sport Exhaust Setting

When your chartplotter is connected to a compatible Mercury engine, you can use the Mercury Engine overlay on the chartplotter to enable the Sport Exhaust setting. The Sport Exhaust setting alters the engine sound.

On the **Mercury Engine** overlay, select **Sport Exhaust > On**.

TIP: You can select  from the menu bar to quickly open the overlay.

TIP: You can also enable the Sport Exhaust setting from the Mercury gauges page menu.

Mercury® Active Trim Control

WARNING

You are responsible for the safe and prudent operation of your vessel. Mercury Active Trim Control does not control boat speed, does not steer the boat for you, and does not avoid navigational hazards. Failure to safely operate your boat could result in an accident causing property damage, serious personal injury, or death.

When your chartplotter is connected to a compatible Mercury Active Trim system, you can control the system using the Active Trim overlay on the chartplotter.

Adding the Mercury® Active Trim Overlay

1 From the page where you want to add the overlay, select **••• > Edit Overlays**.

TIP: You can also select  from the menu bar to quickly change the overlays.

2 Select **Top Bar, Bottom Bar, Left Bar, or Right Bar**.

3 Select **Active Trim**.

Mercury® Active Trim Overlay

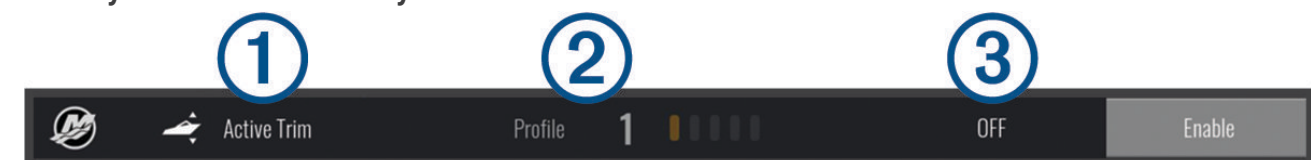

①	When enabled, you can manually adjust the trim.
②	When enabled, you can change between Mercury active trim preset profiles.
③	Active trim system status.
Enable or Disable	Select to turn the active trim system on or off.

Dometic® Optimus® Features

When connected to a compatible Optimus system, the chartplotter allows you to access and control the system. You can enable the Optimus overlay to control the Optimus system ([Activating the Optimus® Overlay Bar, page 131](#)).

When necessary, the Optimus system provides messages with information, instructions, and alerts about faults and hazards.

A no swimming icon  indicates that you should not swim when certain Optimus modes are active. In these modes, propeller control is automatic and could injure someone in the water.

Activating the Optimus® Overlay Bar

1 From a chart, select **••• > Edit Overlays**.

2 Select **Top Bar, Bottom Bar, Left Bar, or Right Bar**.

3 Select **Optimus Bar**.

Optimus® Overlay Bar Overview

To use the overlay bar, you must connect your Optimus system to your chartplotter and add the overlay bar to the necessary screens ([Activating the Optimus® Overlay Bar, page 131](#)).

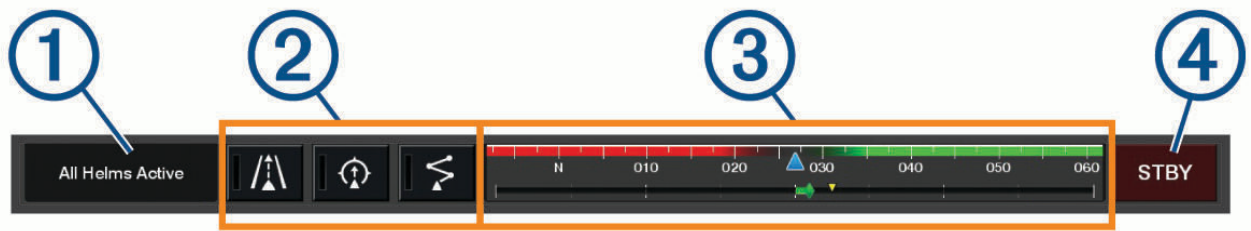

①	All Helms Active
②	Autopilot heading hold, Autopilot track mode, Autopilot route mode
③	Rudder
④	STBY

You must press a mode button on the overlay bar to engage or disengage the mode. When the mode is engaged, the button is illuminated.

The overlay bar configuration and buttons vary, based on systems, modes, and equipment. Refer to your Optimus documentation for more information.

Optimus® Overlay Symbols

	Autopilot heading hold
	Autopilot track mode
	Autopilot route mode
	SeaStation® position hold
	SeaStation heading hold

Optimus® Limp Home Mode

⚠ WARNING

In the event of a steering failure, Optimus Limp Home mode becomes available. Limp Home mode is a system override that may severely limit your boat's control. It should only be used in an emergency if you are unable to call for assistance. Proceed with extreme caution. Read the Optimus owner's manual and always wear a personal flotation device (PFD).

You are responsible for the safe and prudent operation of your vessel. Use of Limp Home mode does not relieve you of the responsibility of safely operating your boat. Avoid navigational hazards and never leave the motor controls unattended.

When available, the Limp Home button appears on the Optimus overlay bar. Refer to the Optimus owner's manual before using Limp Home mode.

To engage Limp Home mode from any screen, select **Where To > Warning Manager > Steering Limp Home**.

Tide, Current, and Celestial Information

Tide and Current Overlays

1

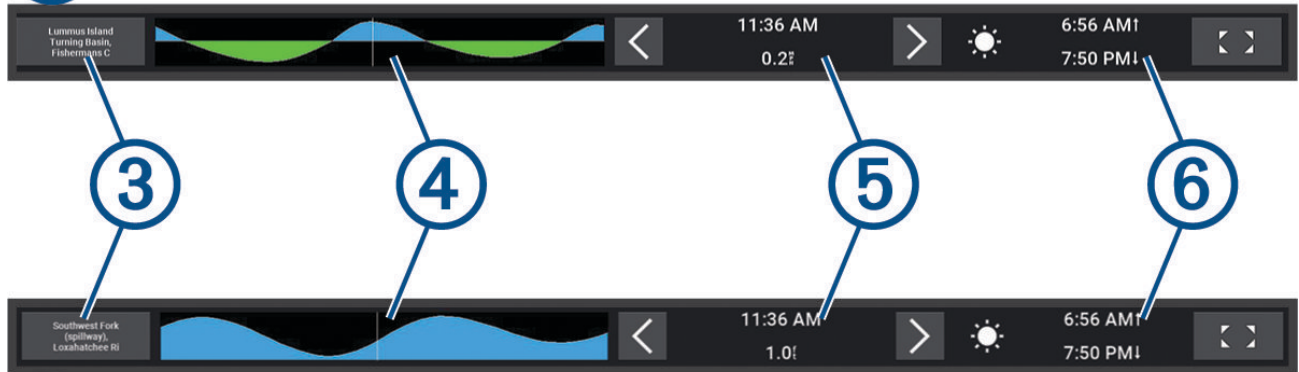

2

1	Tide station overlay bar.
2	Current station overlay bar.
3	Name of the selected tide or current station. Select to change to a different tide or current station.
4	Tide or current station graph.
5	Present time, indicated on the tide or current station graph as a white line. You can select < and > to adjust the time on the tide or current station graph.
6	Present sunrise and sunset times.
< >	Select to open the tide or current station information page.

Adding Tide and Current Overlays

- From the page where you want to add the overlay, select **☰ > Edit Overlays**.
TIP: You can also select **☰** from the menu bar to quickly change the overlays.
- Select **Top Bar**, **Bottom Bar**, **Left Bar**, or **Right Bar**.
- Select **Tides** or **Currents**.

Tide Station Information

⚠ WARNING

Tide and current information is for information purposes only. It is your responsibility to heed all posted water-related guidance, to remain aware of your surroundings, and to use safe judgment in, on, and around the water at all times. Failure to heed this warning could result in property damage, serious personal injury, or death.

You can view information about a tide station for a specific date and time, including the tide height, and when the next high and low tides will occur. By default, the Tides overlay bar on the chartplotter shows tide information for the most recently viewed tide station, present date, and past hour.

From the Tides overlay bar, select **<** **>**.

Current Station Information

⚠ WARNING

Tide and current information is for information purposes only. It is your responsibility to heed all posted water-related guidance, to remain aware of your surroundings, and to use safe judgment in, on, and around the water at all times. Failure to heed this warning could result in property damage, serious personal injury, or death.



NOTE: Current station information is available with certain detailed maps.

You can view information about a current station for a specific date and time, including the current speed and level of the current. By default, the Currents overlay bar on the chartplotter shows current information for the most recently viewed current station and for the present date and time (*Tide and Current Overlays*, page 133).



From the Currents overlay bar, select  .

Celestial Information



You can view information about sunrise, sunset, moonrise, moonset, moon phase, and the approximate sky view location of the sun and moon. The center of the screen represents the sky overhead, and the outermost rings represent the horizon. By default, the chartplotter shows celestial information for the present date and time.

From the Tides or Currents overlay bar, select  , then select **Celestial**.

Viewing Tide Station, Current Station, or Celestial Information for a Different Date

- 1 From a **Tides** or **Currents** overlay bar, select  .
- 2 To view celestial information, select **Celestial**.
- 3 Select an option:
 - To view information for a different date, select **Change Date**, and enter a date.
 - To view information for today, select **Current Date and Time**.
 - If available, to view information for the day after the date shown, select **Next Day**.
 - If available, to view information for the day before the date shown, select **Previous Day**.

Viewing Information for a Different Tide or Current Station

- 1 From a **Tides** or **Currents** overlay bar, select  .
- 2 Select **Nearby Stations**.
- 3 Select a station.



Viewing Almanac Information from the Navigation Chart

- 1 From a chart or 3D chart view, select a tide station or a current station icon.
- 2 Select the name of the station.

Messages and Warnings

You can open a menu to view important messages and warnings, and to access other communications such as DSC.

Select .

During an active warning, an indicator () replaces the icon on the menu bar (). This color-coded icon conveys the nature of the warning, and if you have more than one message to review, it prioritizes the highest-severity warning.

Color	Severity
Red	Hazards that require immediate action to avoid severe personal injury or death
Yellow	Hazards or unsafe practices which could result in minor personal injury or product or property damage

Viewing Messages and Warnings

1 Select .

NOTE: This appears as an indicator () if there is an active warning.
A window opens that shows messages and any active warnings.

2 Select an option:

- Select a message or an active warning.
- Select **All Communications > Alarm History**.

3 If necessary, select an item in the list.

4 Select **Review**.

Sorting and Filtering Messages

1 Select .

NOTE: This appears as an indicator () if there is an active warning.

2 Select **All Communications > Alarm History > Sort/Filter**.

3 Select an option to sort or filter the message list.

Saving Messages to a Memory Card

1 Insert a memory card into the card slot.

2 Select .

NOTE: This appears as an indicator () if there is an active warning.

3 Select **All Communications > Alarm History > Save to Card**.

Clearing all Messages and Warnings

1 Select .

NOTE: This appears as an indicator () if there is an active warning.

2 Select **All Communications > Alarm History > Clear Alarm History**.

Media Player

If you have a compatible stereo or stereos connected to the chartplotter, you can control the audio using the media player on the chartplotter:

- If you have a compatible Fusion® stereo connected to the NMEA 2000® network or the Garmin® Marine Network, you can control the stereo using the chartplotter. The chartplotter should automatically detect the stereo.
- If you have multiple Fusion stereos connected to one another using Fusion PartyBus™ networking, you can control the networked stereos and groups using the chartplotter. As long as you have one of the networked Fusion stereos connected to the NMEA 2000 network or the Garmin Marine Network, the chartplotter should automatically detect the stereos.
- If you have a compatible third-party stereo connected to the NMEA 2000 network, you may be able to control the stereo using the chartplotter.

NOTE: Not all features are available on all connected stereos.

NOTE: You can play media only from sources that are connected to the stereo.

Opening the Media Player









Before you can open the media player, you must connect a compatible device to the chartplotter.

Select **Vessel > Media**.

TIP: To quickly add the media overlay to a page, select  > **Media > Add**.

Media Player Icons

NOTE: Not all devices have these icons.

Icon	Description
★	Saves or deletes a channel as a preset
	Repeats all songs
	Repeats one song
	Scans for AM/FM radio stations Skips to next or previous track (tap) Fast forwards or rewinds (hold)
	Shuffles
	Increases the volume
	Decreases the volume
	Mutes volume
	Expands the media player to full screen

Selecting the Media Device and Source

You can select the media source connected to the stereo. When you have multiple stereo or media devices connected on a network, you can select the device from which you want to play music.

NOTE: You can play media only from sources that are connected to the stereo.

NOTE: Not all features are available on all media devices and sources.

- 1 From the media screen, select **Devices**, and select the stereo.
- 2 From the media screen, select **Source**, and select the media source.

NOTE: The Devices button only appears when more than one media device is connected to the network.

NOTE: The Source button only appears for devices that support multiple media sources.

Adjusting the Volume and Audio Levels

Adjusting the Volume



If your vessel's media system is set up in zones, the volume controls on the media screen adjust the volume for the Home Zone ([Selecting the Home Zone, page 138](#)).

From the media screen, use the slider or  and  to adjust the volume.

Adjusting the Audio Level

You can use the equalizer to adjust the audio levels on a connected media device.

If the media system has multiple zones, adjusting the audio level tone controls affects the home zone only. You can change the home zone to adjust the audio levels in other zones ([Selecting the Home Zone, page 138](#)).

- 1 From the media screen, select **••• > Audio Levels**.
- 2 Select - or + to adjust the audio levels you want to change.

Muting the Media Volume

- 1 From the media screen, select x.
- 2 If necessary, select **Select**.

Automatic Volume Adjustment Based on Speed

If your stereo is connected to a NMEA 2000® network with a device that provides speed information such as an engine, chartplotter, GPS antenna, water speed sensor, or wind speed sensor, you can set the stereo to adjust the volume automatically based on the selected speed source ([Enabling Automatic Volume Adjustment Based on Speed, page 137](#)).

For example, if a chartplotter with an internal GPS antenna or a stand-alone GPS antenna is on the same NMEA 2000 network as the stereo and you set the Speed Source to Speed Over Ground, the volume increases as your speed increases.

NOTE: When the volume increases to adjust for speed, the actual volume output changes, but the volume-level indicator bar and number stays the same.

For more information about connecting the stereo to a NMEA 2000 network, see the installation instructions for your stereo.

Enabling Automatic Volume Adjustment Based on Speed

- 1 From the **Media** screen, select **••• > Installation**.
- 2 Select the name of the stereo.
- 3 Select **Zones > Speed Vs Volume > Enable**.
- 4 If needed, update the settings to select the speed source and volume settings.

Automatic Volume Control Settings

Select **••• > Installation**, select the name of the stereo, then select **Zones > Speed Vs Volume**.

Enable: Enables the automatic volume control feature.

Speed Source: Sets the source that the stereo uses to determine the speed ([Speed Source Information, page 137](#)).

Max/Min Speed: Sets the expected maximum and minimum speed range for the selected Speed Source. The Minimum setting indicates the speed at which the volume plays at the level you set by turning the dial. The Maximum setting indicates the speed at which the volume plays at the highest level set in the Volume Increase setting.

TIP: You should start by setting these values at the speeds you typically expect from your engine or sensor and adjust them as needed.

Volume Increase: Sets the total volume increase for each zone when the selected Speed Source reaches the set maximum speed set in the Max/Min Speed setting. The higher you set this level, the louder the volume will be as you approach the set maximum speed.

NOTE: When the volume increases to adjust for speed, the actual volume output changes but the volume-level indicator bar and number stays the same.

Speed Source Information

Select **••• > Installation**, select the name of the stereo, then select **Zones > Speed Vs Volume > Speed Source**.

Engine Speed: Uses the RPM reading provided by a supported NMEA 2000® engine. The volume increases as the engine RPM increases from the set Minimum speed to the set Maximum speed. If multiple supported engines are connected, the stereo uses the average RPM reading from all engines.

Speed Over Ground: Uses the speed over ground (SOG) reading provided by a supported NMEA 2000 GPS antenna or chartplotter with an internal GPS antenna. The volume increases as the SOG increases from the set Minimum speed to the set Maximum speed.

Speed Through Water: Uses the speed through water (STW) reading provided by a supported NMEA 2000 water-speed sensor. The volume increases as the STW increases from the set Minimum speed to the set Maximum speed.

Wind Speed: Uses the wind speed reading provided by a supported NMEA 2000 wind-speed sensor. The volume increases as the wind speed increases from the set Minimum speed to the set Maximum speed.

Stereo Zones and Groups

The Zones button appears only for stereos that support multiple speaker zones.

The Groups option appears only when you have multiple Fusion® stereos connected to one another using Fusion PartyBus™ networking.

If a connected stereo is set up to support multiple speaker zones, you can control the audio of the zones individually from the media screen on the chartplotter. For example, you could make the audio quieter in the cabin and louder on the deck ([Adjusting the Zone Volume, page 138](#)).

If you have multiple Fusion stereos connected to one another using Fusion PartyBus networking, you can create stereo groups and control the networked stereos and groups using the chartplotter.

Depending on the capabilities of the stereo or stereos connected to the chartplotter, you may have multiple options for controlling zone audio:

- For third-party stereos and compatible Fusion stereos, the Local Zones tab allow you to adjust the volume for all of the enabled speaker zones on the connected stereo.
- For multiple Fusion stereos connected to one another using Fusion PartyBus networking, the Group Zones tab allows you to adjust the volume for any zones on a stereo in the same group as Home Zone.
- For multiple Fusion stereos connected to one another using Fusion PartyBus networking, the Network tab allows you to adjust the volume for any zone on any stereo connected to the Fusion PartyBus network.

Selecting the Home Zone

If you have multiple stereos connected to the chartplotter, or have a stereo or stereos with multiple speaker zones connected to the chartplotter, you must designate one speaker zone on one stereo as the home zone. The playback and volume controls on the media screen adjust only the stereo or zone set as the home zone. The playback information on the media screen shows the source playing on the Home Zone stereo.

It is recommended to set the home zone as the zone closest to the chartplotter.

NOTE: Some stereos may feature a global zone. Setting a global zone as the home zone allows the controls on the media page to affect all of the zones on a stereo or media device.

The Zones button only appears for stereos or media devices that support multiple media zones.

- 1 From the media screen, select **••• > Home Zone**.
- 2 If necessary, select a connected stereo.
- 3 Select the zone you want to set as the **Home Zone**.
The name of the selected home zone appears on the media screen.

Adjusting the Zone Volume

The Zones button appears only for stereos that support multiple speaker zones.

- 1 From the media screen, select **Zones**.
A list of available zones appears.
- 2 If necessary, change the zone group to view the zone you want to adjust ([Stereo Zones and Groups, page 138](#)).
- 3 Select **◀-** and **▶+** to adjust the volume for a zone.

Disabling a Speaker Zone

If your connected media device features speaker zones, you can disable unused zones.

- 1 From the media screen, select **••• > Installation**.
- 2 Select a connected stereo.
- 3 Select **Zones**.
- 4 Select the zone you want to disable.
- 5 Select **Enable**.
The green bar on the button turns gray to indicate that the zone is disabled. You can select Enable to enable a disabled zone.

Creating a Group

If you have multiple Fusion® stereos connected to each other using Fusion PartyBus™ networking, you can create stereo groups and control the networked stereos and groups using the chartplotter. One stereo must be connected to the chartplotter through the NMEA 2000® network.

See the installation instructions and owner's manual provided with your compatible Fusion stereo for full information about how to install and configure a Fusion PartyBus network.

There are some limitations when streaming sources on the Fusion PartyBus network. See the owner's manual for your Fusion stereo for more information.

- 1 From the media screen, select **••• > Groups**.
- 2 Select the name of the stereo you want to be the primary stereo in the group, and select **Set as Source**.
- 3 Select the stereos you want to include in the group.
- 4 Select **Done**.

Editing a Group

- 1 From the media screen, select **••• > Groups**.
- 2 Select the name of an existing group.
- 3 Select the stereos you want to add to or remove from the group.
- 4 Select **Done**.

Group Synchronization

By default, groups you create are not maintained when you turn off stereos in the group. If you turn off a single stereo added to the group, it leaves the group. If you turn off the primary stereo in the group, the group is dissolved. You can enable group synchronization to preserve group membership for a stereo after turning it off. Group synchronization behaves differently based on how you turn the stereos off and on.

- If you turn a synchronized stereo off and on by using either the power button on the stereo or a physical switch on the ignition wire (the red wire), all of the synchronized stereos in the group turn off and on together. This applies to all of the synchronized stereos in the group, whether or not a stereo is the primary stereo in the group.
NOTE: Selecting ALL OFF from the power menu on a stereo turns off all stereos on the network, even if they are not in a group or have group synchronization enabled.
- If you turn a synchronized stereo off and on using a physical switch on the power wire (the yellow wire), the other synchronized stereos in the group behave differently:
 - If the synchronized stereo is the primary stereo in the group and you turn it off using a physical switch on the power wire, the other synchronized stereos in the group remain on, but leave the group. When you turn the primary stereo back on again, the other synchronized stereos rejoin the group.
 - If the synchronized stereo is not the primary stereo in the group and you turn it off and on using a physical switch on the power wire, all of the other synchronized stereos in the group remain on and grouped, and the stereo rejoins the group when you turn it on again.

Enabling Group Synchronization

You must remove the stereo from an existing group before you can enable the Save Group setting. You cannot update settings when a stereo is part of a group.

You must enable this setting on each stereo that you want to retain group settings after a power cycle.

- 1 From the **Media** screen, select **••• > Installation**.
- 2 Select the name of the stereo.
- 3 Select **Power Options > Save Group**.
The stereo retains group settings after a power cycle.
- 4 Repeat for additional stereos as needed.

NOTE: You must enable Save Group on all networked stereos for synchronization to work properly.

Playing Music

Browsing for Music

You can browse for music in some media sources.

- 1 From the media screen and an applicable source, select the button with the source name, such as **USB**.
- 2 Browse for, and select an item to play.

Enabling Alphabetical Search

You can enable the alphabetical search feature to find a song or album in a large list.

- 1 From the media screen, select **••• > Installation**.
- 2 Select the device.
- 3 Select **Alpha Search**.
- 4 Select the maximum number of tracks to appear in the search results.

To disable the alphabetical search feature, select Alpha Searching Off.

Setting a Song to Repeat

1 From the media screen while a song is playing, select an option.

- Select **⋮** > **Repeat**.
- Select **⋮** > **Browse** > **Repeat**.

2 If necessary, select **Single**.

Not all media devices and sources support the Single option for the Repeat control.

Setting All Songs to Repeat

Not all media devices and sources support the All option for the Repeat control.

From the media screen, select an option:

- Select **⋮** > **Repeat** > **All**.
- Select **⋮** > **Browse** > **Repeat** > **All**.

Setting Songs to Shuffle

From the media screen, select an option:

- Select **⋮** > **Shuffle**.
- Select **⋮** > **Browse** > **Shuffle**.

Radio

To listen to AM or FM radio, you must have a suitable marine AM/FM antenna properly connected to the stereo and be within range of a broadcasting station. For instructions on connecting an AM/FM antenna, see the stereo installation instructions.

To listen to SiriusXM® radio, you must have the appropriate equipment and subscriptions ([SiriusXM® Satellite Radio, page 142](#)). For instructions on connecting a SiriusXM Connect Vehicle Tuner, see the stereo installation instructions.

To listen to DAB stations, you must have the appropriate equipment ([DAB Playback, page 141](#)). For instructions on connecting a DAB adapter and antenna, see the installation instructions provided with your adapter and antenna.

To listen to DAB stations, you must have a DAB-compatible stereo connected the chartplotter with the appropriate DAB equipment connected to the stereo ([DAB Playback, page 141](#)). For instructions on connecting a DAB antenna (and adapter, if necessary), see the installation instructions provided with your stereo, antenna, and adapter.

Setting the Tuner Region

1 From the media screen, select **⋮** > **Installation** > **Tuner Region**.

2 Select an option.

Changing the Radio Station

1 From the media screen, select an applicable source, such as **FM**.

2 Select **◀** or **▶** to tune to a station.

Changing the Tuning Mode

You can change how you select a station for some media types, such as FM or AM radio.

NOTE: Not all tuning modes are available for all media sources.

Press the button between the **◀** and **▶** buttons to cycle between the tuning modes:

- To select a station manually, select **MANUAL**.
- To scan or stop on the next available station, select **AUTO**.
- To select a saved station preset, select **FAVORITE**.
- To select a category in some media sources, select **CATEGORY**.

Presets

You can save your favorite AM stations and FM stations as presets for easy access.

You can save your favorite SiriusXM® channels if the stereo is connected to an optional SiriusXM tuner and antenna.

You can save your favorite DAB stations if the stereo is connected to the proper DAB equipment and set to the correct tuner region. ([DAB Playback, page 141](#))

You can save your favorite DAB stations if you have a DAB-compatible stereo connected the chartplotter with the appropriate DAB equipment connected to the stereo ([DAB Playback, page 141](#))

Saving a Station as a Preset

- 1 From an applicable media screen, tune to the station to save as a preset.
- 2 Select **Favorites > Add Current Channel**.

Selecting a Preset

- 1 From an applicable media screen, select **Favorites**.
- 2 Select a preset from the list.
- 3 Select **Tune to Channel**.

Removing a Preset

- 1 From an applicable media screen, select **Favorites**.
- 2 Select a preset from the list.
- 3 Select **Remove Current Channel**.

DAB Playback

When you connect a compatible Digital Audio Broadcasting (DAB) module and antenna, such as the Fusion® MS-DAB100A to a compatible stereo, you can tune in to and play DAB stations

To use the DAB source, you must be in a region in which DAB is available, and select the tuner region ([Setting the DAB Tuner Region, page 141](#)).

Setting the DAB Tuner Region

You must select the region you are in to receive DAB stations properly.

- 1 From the media screen, select **••• > Installation > Tuner Region**.
- 2 Select the region you are in.

Scanning for DAB Stations

- 1 Select the **DAB** source.
- 2 Select **Scan** to scan for available DAB stations.

When scanning is complete, the first available station in the first ensemble found begins playing.

NOTE: After the first scan is complete, you can select Scan again to re-scan for DAB stations. When the re-scan is complete, the system starts playing the first station in the ensemble you were listening to when you started the re-scan.

Changing DAB Stations

- 1 Select the **DAB** source.
- 2 If necessary, select **Scan** to scan for local DAB stations.
- 3 Select **◀** or **▶** to change the station.

When you reach the end of the current ensemble, the stereo automatically changes to the first available station in the next ensemble.

TIP: You can hold **◀** or **▶** to change the ensemble.

Selecting a DAB Station from a List

- 1 From the DAB media screen, select **Browse > Stations**.
- 2 Select a station from the list.

Selecting a DAB Station from a Category

- 1 From the DAB media screen, select **Browse > Categories**.
- 2 Select a category from the list.
- 3 Select a station from the list.

DAB Presets

You can save your favorite DAB stations as presets for easy access.

You can save up to 15 DAB-station presets.

Saving a DAB Station as a Preset

- 1 From the DAB media screen, select the station to save as a preset.
- 2 Select **Browse > Favorites > Save Current**.

Selecting a DAB Preset from a List

- 1 From the DAB media screen, select **Browse > Favorites > View Presets**.
- 2 Select a preset from the list.

Removing DAB Presets

- 1 From the DAB media screen, select **Browse > Favorites**.
- 2 Select an option:
 - To remove one preset, select **Remove Preset**, and select the preset.
 - To remove all presets, select **Remove All Presets**.

SiriusXM® Satellite Radio

When you have a compatible Fusion® stereo and SiriusXM Connect Tuner installed and connected to the chartplotter, you may have access to SiriusXM satellite radio, depending on your subscription.

Locating a SiriusXM® Radio ID

Before you can activate your SiriusXM subscription, you must have the radio ID of your SiriusXM Connect Tuner. You can locate the SiriusXM Radio ID on the back of the SiriusXM Connect Tuner, on the back of its packaging, or by tuning your chartplotter to channel 0.

- 1 Select **Media > Source > SiriusXM**.
- 2 Tune to channel 0.

The SiriusXM radio ID does not include the letters I, O, S, or F.

Activating a SiriusXM® Subscription

- 1 With the SiriusXM source selected, tune to channel 1.
You should be able to hear the preview channel. If not, check the SiriusXM Connect Tuner and antenna installation and connections, and try again.
- 2 Tune to channel 0 to locate the Radio ID.
- 3 Contact SiriusXM listener care by phone at (866) 635-2349 or go to siriusxm.com/activatenow to subscribe in the United States.
- 4 Provide the Radio ID.
The activation process usually takes 10 to 15 minutes, but can take up to an hour. For the SiriusXM Connect Tuner to receive the activation message, it must be turned on and receiving the SiriusXM signal.
- 5 If the service is not activated within the hour, go to <http://care.siriusxm.com/refresh> or contact SiriusXM Listener Care by phone at 1-866-635-2349.

Customizing the Channel Guide

SiriusXM® radio channels are grouped in categories. You can select the categories of channels that appear in the channel guide.

Select an option:

- If the media device is a compatible Fusion® stereo, select **Media > Browse > Channel**.
- If the media device is a GXM™ antenna, select **Media > ... > Category**.

Saving a SiriusXM® Channel to the Presets List

You can save your favorite channels to the presets list.

- 1 Select **Media**.
- 2 Select the channel to save as a preset.
- 3 Select an option:
 - If the media device is a compatible Fusion® stereo, select **Browse > Favorites**.
 - If the media device is a GXM™ antenna, select **... > Favorites > Add Current Channel**.

Parental Controls

The parental control feature allows you to limit access to any SiriusXM channels, including those with mature content. When the parental control feature is enabled, you must enter a passcode to tune to the locked channels. You can also change the 4-digit passcode.

Unlocking SiriusXM® Parental Controls

1 From the media screen, select **Browse > Parental > Unlock**.

2 Enter your passcode.

The default passcode is 0000.

Setting Parental Controls on SiriusXM® Radio Channels



Before you can set parental controls, the parental controls must be unlocked.

The parental control feature allows you to limit access to any SiriusXM channels, including those with mature content. When enabled, the parental control feature requires you to enter a passcode to tune to the locked channels.

Select **Browse > Parental > Lock/Unlock**.

A list of channels appears. A checkmark indicates a locked channel.

NOTE: When you view the channels after setting parental controls, the display changes:

-  indicates a locked channel.
-  indicates an unlocked channel.

Clearing All Locked Channels on a SiriusXM® Radio

Before you can clear all locked channels, the parental controls must be unlocked.

1 From the media screen, select **Browse > Parental > Clear All Locked**.

2 Enter your passcode.

Restoring Default Parental Control Settings Values

This process deletes all the settings information you have entered. When you restore the parental control settings to their default values, the passcode value is reset to 0000.

1 From the media menu, select **Installation > Factory Defaults**.

2 Select **Yes**.

Changing a Parental Passcode on a SiriusXM® Radio

Before you can change the passcode, the parental controls must be unlocked.

1 From the media screen, select **Browse > Parental > Change PIN**.

2 Enter your passcode and select **Done**.

3 Enter a new passcode.

4 Confirm the new passcode.

Setting the Device Name

1 From the media screen, select **••• > Installation > Set Device Name**.

2 Enter a device name.

3 Select **Select** or **Done**.

Updating the Media Player Software

You can update the software on compatible connected stereos and accessories.

See the stereo *Owner's Manual* at support.garmin.com for instructions on updating the software.

Configuring a Stereo from the Chartplotter

You can configure various features of a compatible connected stereo using the chartplotter.

- 1 From the **Media** screen, select **••• > Installation**.
- 2 Select the name of the stereo.
- 3 Select a setting to configure.

NOTE: See the latest *Owner's Manual* for the stereo for more information about the settings you can configure.

LED Lighting Control

If you have installed a Garmin Spectra™ lighting controller, you can use the chartplotter to activate and change connected LED lights. You can quickly turn LED lights on and off, and you can adjust the brightness, color, and effects. You can also create groups of connected LED lights and specialized scenes to quickly toggle different lights and lighting effects.

When a compatible Fusion® stereo is connected to the same NMEA 2000® as the Garmin Spectra lighting controller and chartplotter, you can control lights from the stereo and you can configure lights so they react to music played on the stereo.

Before you can access LED lighting control on the chartplotter, you must install one or more Garmin Spectra lighting controllers and connect your LED lights. See the installation instructions provided with the Garmin Spectra lighting controller for installation details.

You can access LED lighting screen by selecting **Vessel > Lighting**.

WARNING

Setting some LED light effects or setting the LED lights to react to music may result in lights flashing at various intervals. Consult your physician if you have epilepsy or are sensitive to bright or flashing lights.

NOTICE

Before you can control any connected lights using the chartplotter or a compatible stereo, you must first initialize the lights (*Initializing Connected LED Lights*, page 145).

Using certain LED colors on your vessel, such as red and green, may violate the laws, regulations, and standards related to the use and/or operation of marine navigation lights. It is the user's responsibility to comply with any such applicable laws, regulations, and standards. Garmin® is not responsible for any fines, penalties, citations, or damages that may be incurred due to any such lack of compliance.

LED Light Controller Configuration

You can configure information about the connected Garmin Spectra™ lighting controllers and connected LED lights. You must define the type of LED lights connected before you can use them in the software on your connected chartplotter or stereo.

Initializing Connected LED Lights

Before you can interact with any connected LED lights using the chartplotter or stereo, you must first initialize the lights by providing information about the type of light source supported by the connected LEDs.

- 1 From the lighting control screen, select **••• > Installation > Lights**.

A list of all available lights is shown. Any light indicated with a yellow circle and Not Used as the Light Output must be initialized before it's available for use by the system.

- 2 Select a light from the list on the left.

- 3 Select **Light Output** and select the type of LEDs connected:

- **RGB**: The connected dimmable LEDs support a full range of colors.
- **RGBW**: The connected dimmable LEDs support a full range of colors and high quality white light.
- **CRGBW**: The connected dimmable LEDs support a full range of colors and multiple temperature white light.
- **Single Channel**: The dimmable LEDs support one dedicated color.

TIP: You can select Identify to illuminate the selected light to help identify and test the selected LED type.

- 4 Repeat this procedure for all connected lights until all of the intended LED lights are initialized.

Renaming an LED Light

You can provide a custom name to a connected LED light to make it easier to identify on the LED lighting control screen and in configuration menus.

Custom LED light names are synchronized between chartplotters connected using a wired or wireless NETWORK connection only. LED light names are not synchronized across the NMEA 2000® network. If you have multiple chartplotters connected through the NMEA 2000 network only, you must make changes to the custom LED light names on all chartplotters individually. To change the names on compatible Fusion® stereos, you must use the ActiveCaptain® app. See the stereo Owner's Manual for more information.

- 1 From the lighting control screen, select **••• > Installation > Lights**.

A list of all available lights is shown.

- 2 Select a light you want to rename.

- 3 Select **Rename**, and enter a new name for the light.

Associating LED Lights with an Audio Zone

If a Garmin Spectra™ lighting controller is connected to the same NMEA 2000® network as a compatible Fusion® stereo, you can associate connected lights with an audio zone on the stereo. When lights are associated with an audio zone on a stereo, you can configure the lights to synchronize with the music playing on the associated audio zone.

- 1 From the lighting control screen, select **••• > Installation > Lights**.
A list of all available lights and light groups is shown.
- 2 Select a light you want to associate with an audio zone from the list on the left.
- 3 Select **Audio Zones > Select Audio Zone**.
A list of audio zones on all connected compatible Fusion stereos is shown.
- 4 Select the audio zone to which you want to associate the lights.

Renaming an LED Lighting Controller

By default, all lighting controllers connected to the same NMEA 2000® network as the chartplotter are assigned a general name. You can rename connected controllers for easier identification.

Lighting controller information, such as the history of connected controllers and custom names, is synchronized between chartplotters connected using a wired or wireless NETWORK connection only, and is not synchronized across the NMEA 2000 network. If you have multiple chartplotters connected through the NMEA 2000 network only, you must make any changes on all chartplotters individually.

- 1 From the lighting control screen, select **••• > Installation > Lighting Controllers**.
A list of all connected lighting controllers is shown.
- 2 Select a lighting controller.
- 3 Select **Rename**, and enter a new name for the lighting controller.

Removing an LED Lighting Controller

When you connect a lighting controller to the same NMEA 2000® network as the chartplotter, the lighting controller information is saved on the chartplotter, even if you disconnect the lighting controller. If you are completely removing a controller or replacing it with a new controller, you can remove the saved information about the old controller from the chartplotter.

Lighting controller information, such as the history of connected controllers and custom names, is synchronized between chartplotters connected using a wired or wireless NETWORK connection only, and is not synchronized across the NMEA 2000 network. If you have multiple chartplotters connected through the NMEA 2000 network only, you must make any changes on all chartplotters individually.

- 1 From the lighting control screen, select **••• > Installation > Lighting Controllers**.
A list of all connected lighting controllers is shown. Disconnected controllers are indicated by a black X.
- 2 Select a lighting controller you want to remove.
- 3 Select **Forget**.

LED Lighting Control Screen

You can access LED lighting screen by selecting **Vessel > Lighting**.

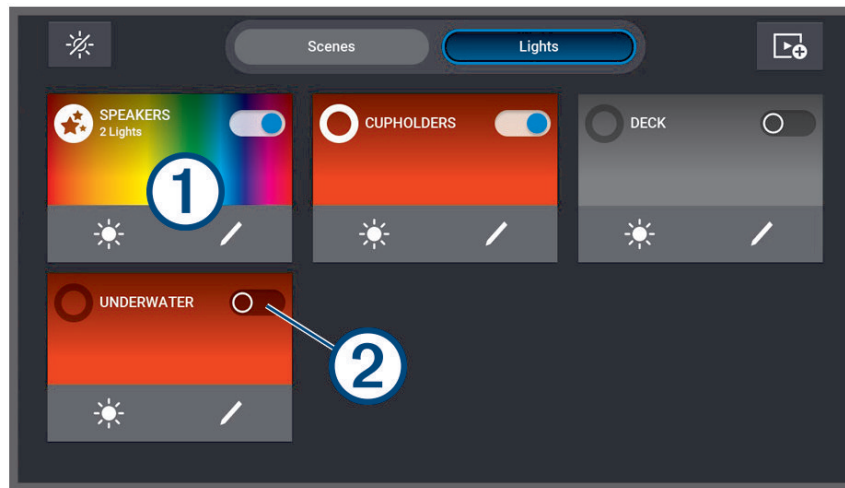

	Turns off all connected lights and scenes.
Scenes	Shows all created scenes.
Lights	Shows all connected LED lights and light groups.
	Creates a new scene.
①	Light, light group, or scene name and information. Select to turn a light or light group on and off. Select to start a scene.
②	Shows whether the light or light group on and off.
	Quickly adjust the brightness of the light, light group, or scene.
	Quickly edit the properties, color, and effects of a light, light group, or scene.

Turning LED Lights On and Off

- 1 From the lighting control screen, select **⋮ > Edit Light**.

A list of all available lights and light groups is shown.

- 2 Select a light or light group.

- 3 Select **Turn On** or **Turn Off**.

TIP: You can select the toggle switch on the light or light group directly from the lighting control screen to quickly turn lights and light groups on and off.

Adjusting LED Light Brightness

- 1 From the lighting control screen, select **⋮ > Edit Light**.

A list of all available lights and light groups is shown.

- 2 Select the light or light group you want to adjust.

- 3 Adjust the brightness level on the bottom of the screen for the selected light or light group.

TIP: You can select on the light or light group directly from the lighting control screen to quickly adjust the brightness for a light or group of lights.

Changing LED Light Color

- 1 From the lighting control screen, select **⋮ > Edit Light**.

A list of all available lights and light groups is shown.

- 2 Select a light or light group.

- 3 Select **Color Pick > Color**.

- 4 Depending on the type of light connected, select an option:

- To change the RGB color of a connected light, select **Color**.
- To change the tone of a white light, select **White**.

A color or white light gradient window is shown, along with a set of predefined colors or white light selections.

- 5 Select a color or white tone.

TIP: You can select  on the light or light group directly from the lighting control screen to quickly adjust the color or effect for a light or group of lights.

Changing LED Light Effects

WARNING

Selecting some LED light effects may result in lights flashing at various intervals. Consult your physician if you have epilepsy or are sensitive to bright or flashing lights.

- 1 From the lighting control screen, select **••• > Edit Light**.
A list of all available lights and light groups is shown.
- 2 Select the light or light group you want to adjust.
- 3 Select **Effects > Effect**.
A list of predefined lighting effects is shown.
- 4 Select an effect from the list.
The screen shows the colors and pattern included in the effect, and the affected light or light group starts using the selected effect.
- 5 If necessary, select **Effect**, and choose a different effect until the light or group of lights uses the preferred effect.
TIP: You can select  on the light or light group directly from the lighting control screen to quickly adjust the effect or color for a light or group of lights.

Setting LED Lights to React to Music

You must associate a light or light group with an audio zone on a connected compatible stereo before you can use the Audio Sync feature and have the lights react to music playing on the stereo ([Associating LED Lights with an Audio Zone](#), page 146).

WARNING

Setting LED lights to react to music may result in lights flashing at various intervals. Consult your physician if you have epilepsy or are sensitive to bright or flashing lights.

- 1 From the lighting control screen, select **••• > Edit Light**.
A list of all available lights and light groups is shown.
- 2 Select the light or light group you want to adjust.
- 3 Select **Audio Sync**.
- 4 Depending on the type of light connected, select an option:
 - If you want the lights to react to quieter and louder elements of the music playing, select **Mode > Color Blend**.
 - If you want the lights to react to the bass and treble frequencies of the music playing, **Mode > Audio Spectrum**.
- 5 If necessary, select the colors associated with the quieter, louder, bass, and treble elements depending on the selected mode.
TIP: You can select  on the light or light group directly from the lighting control screen to quickly adjust the color or effect for a light or group of lights.

LED Light Scenes

A scene is a collection of LED lights that you can set to change to a defined set of colors and effects. You can create up to 20 scenes, with any number of connected lights or light groups in each scene. You can configure all of the lights in a scene to behave the same way or independently of one another.

A scene is different from a light group because you can add a light or light group to any number of scenes you create. You are not limited to how many scenes contain a connected light or light group. A light group is more restrictive and defines specific lights that you want to regularly behave the same way ([LED Light Groups](#), page 149).

LED light scenes you create are synchronized between chartplotters connected using a wired or wireless NETWORK connection only. LED light scene information is not synchronized across the NMEA 2000® network.

If you have multiple chartplotters connected through the NMEA 2000 network only, you must create and make changes to LED light scenes on all chartplotters individually. To create and change scenes on compatible Fusion® stereos, you must use the ActiveCaptain® app. See the stereo Owner's Manual for more information.

Creating a new LED Light Scene

1 From the lighting control screen, select **Scenes**.

2 Select **••• > Create New Scene**.

TIP: You can select  from the lighting control screen at any time to quickly create a new scene.

3 Enter a name for the scene, and select **Done**.

The new scene appears on the lighting control screen.

After creating the scene, you should edit the scene to add or remove lights and define how you want them to behave when you run the scene.

Editing an LED Light Scene

1 From the lighting control screen, select **Scenes**.

2 Select **••• > Edit Scene**.

3 Select the name of the scene.

TIP: You can select  on a scene directly from the lighting control screen to quickly edit the scene.

4 To edit the scene behavior, select one or more options:

- To rename the scene, select **Rename**, and enter the new name.
- If you've changed the status and behavior of lights in the scene and want to update the scene to use the present state of all lights in the scene, select **Resave Scene**.
- To add or remove lights or light groups from the scene, select **Add/Remove Lights**, and select the lights and light groups you want to include in the scene.

Starting an LED Light Scene

Before you can start a scene, you must create at least one scene.

1 From the lighting control screen, select **Scenes**.

2 Select  on a scene to start it.

TIP: If you want to turn off all lights in a scene, select **••• > Edit Scene**, select the name of the scene, and select **Turn Off Lights**.

Deleting an LED Light Scene

You can remove any LED light scenes you created. Deleting a scene does not affect any lights or light groups that were added to the scene.

1 From the lighting control screen, select **Scenes**.

2 Select **••• > Delete Scene**.

3 Select the name of the scene you want to delete, and select **Yes** to confirm.

LED Light Groups

A group consists of two or more connected LED lights associated with one another so they regularly behave the same way. For example, you may have LEDs on a set of speakers connected to one port on a lighting controller, and you may have LEDs on a subwoofer in the same area connected to another port on the lighting controller. By adding both of these sets of lights to a group, they will appear as one toggle on the lighting page and turn on and off together.

A group is different from a scene because a connected LED light can only belong to one group at a time. Also, a group appears on the Lights tab in the lighting page along with other connected lights.

LED light groups you create are synchronized between chartplotters connected using a wired or wireless NETWORK connection only. LED light-group information is not synchronized across the NMEA 2000® network. If you have multiple chartplotters connected through the NMEA 2000 network only, you must create and make changes to LED light groups on all chartplotters individually. To create and change the groups on compatible Fusion® stereos, you must use the ActiveCaptain® app. See the stereo Owner's Manual for more information.

Creating and Adding Lights to an LED Light Group

1 From the lighting control screen, select **••• > Installation > Lights**.

A list of all available lights is shown.

- 2 Select a light you would like to add to a light group and select **Light Group > Select Group**.
- 3 Select **Create New Group**, and enter the name for the new group.
The new group is created, and the selected light is added to the group.
- 4 Select another light to add to the light group, and select **Light Group > Select Group**.
- 5 Select the name of the light group to add the light to the group.
- 6 Repeat until the group contains all of the lights you want to add.

Editing an LED Light Group

- 1 From the lighting control screen, select **••• > Installation > Lights**.
A list of all available lights is shown.
- 2 Select a light to add or remove from a group.
- 3 Select **Light Group**, and select an option:
 - To add the light to a group, select **Select Group**.
 - To move the light to a different group, select **Change Group**, and select a different group or create a new group.
 - To remove the light from a group, select **Remove From Group**.
- 4 Repeat for any additional lights until they are grouped as preferred.

Renaming an LED Light Group

LED light group information is not synchronized across the NMEA 2000® network. You must make changes on all chartplotters individually. To change group information on compatible Fusion® stereos, you must use the ActiveCaptain® app. See the stereo Owner's Manual for more information.

- 1 From the lighting control screen, select **••• > Installation > Lights**.
A list of all available lights is shown.
- 2 Select a light in the group you want to rename.
- 3 Select **Light Group > Rename**, and enter a new name for the group.

HDMI® Out Video Considerations

NOTICE

To prevent corrosion due to moisture, you must use Garmin® accessory cables when connecting the chartplotter to the video display. Using different cables voids your warranty.

The ECHOMAP™ Ultra 2 16Xsv chartplotter models have HDMI out capability to duplicate the chartplotter screen on another device, such as a television or monitor.

The Garmin HDMI accessory cable is 4.5 m (15 ft.) long. If you need a longer cable, you should use an active HDMI cable only. You need an HDMI coupler to connect the two HDMI cables.

You must make all cable connections in a dry environment.

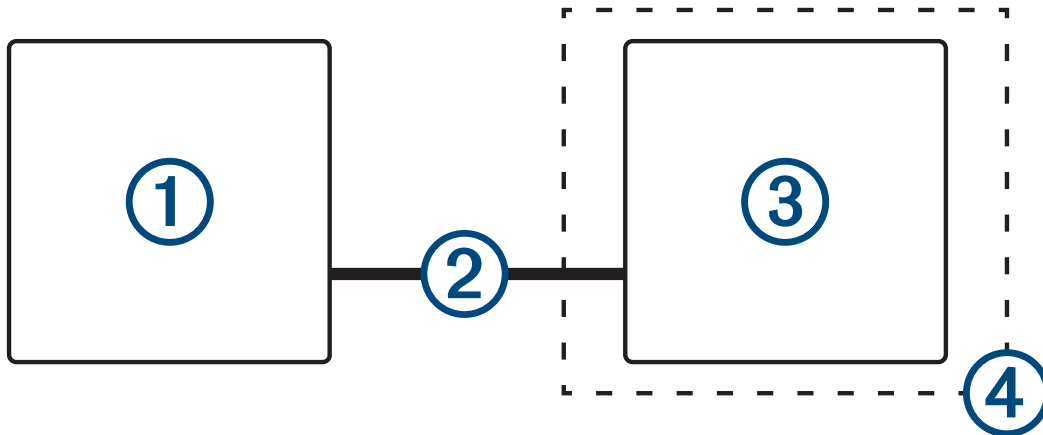

Item	Description
①	ECHOMAP Ultra 2 16Xsv chartplotter
②	Garmin HDMI cable (HDMI)
③	Display with an HDMI In port, such as a monitor or television
④	Dry environment, protected from moisture

Device Configuration

System Settings

Select  > **System**.

Sounds and Display: Adjusts the display settings and the audio settings (if available).

Satellite Positioning: Provides information about the GPS satellites and settings.

System Information: Provides information about the devices on the network and the software version.

Station Information: Adjusts the setup of the station.

Auto Power Up: Controls which devices turn on automatically when power is applied.

Auto Power Off: Automatically turns off the system after it has been asleep for the selected length of time.

Simulator: Turns the simulator on or off and allows you to set the time, date, speed, and simulated location.

Sounds and Display Settings

Select  > **System** > **Sounds and Display**.

Beeper: Turns on and off the tone that sounds for alarms and selections.

Audio Setup: Sets up the audio output.

Backlight: Sets the backlight brightness. You can select the Auto option to adjust the backlight brightness automatically based on the ambient light.

Backlight Sync: Synchronizes the backlight brightness of other chartplotters in the station.

Color Mode: Sets the device to display day or night colors. You can select the Auto option to allow the device to set day or night colors automatically based on the time of day.

Startup Image: Sets the image that appears when you turn on the device.

Startup Layout: Sets the layout that appears when you turn on the device.

Screen Lock: Sets the anti-theft feature that requires a security PIN (Personal Identification Number) to prevent unauthorized use of the device ([Enabling Screen Lock, page 17](#)).

Audio Settings

You can adjust audible alarms, alerts, and warnings that are sounded over connected audio devices.

Select  > **System** > **Sounds and Display** > **Audio Setup**.

Audio Output: Turns on the audio output for audio alerts.

Audio Alerts: Sets which system alarms and alerts are played over the compatible audio output. An alarm indicates a situation could be hazardous to passengers and requires immediate action. A warning indicates the situation could be hazardous to equipment on the vessel or the vessel itself and requires action very soon. All other messages and information are classified as alerts.

Audio Alert Language: Sets the spoken language for alerts.

Audio Alert Device: Sets the device to control when alerts are played.

Audio Alert Source: Switches the audio device to the selected source when an alert is played.

Satellite Positioning (GPS) Settings

These settings may change depending on the selected GPS source. Not all options are available on all models.

Select  > **System** > **Satellite Positioning**.

Source: Allows you to select the preferred source for GPS data.

Speed Filter: Averages the speed of your vessel over a short period of time for smoother speed values.

WAAS/EGNOS: Turns on or off WAAS data (in North America) or EGNOS data (in Europe), which can provide more-accurate GPS position information. When using WAAS or EGNOS data, the device may take longer to acquire satellites.

Positioning Mode > GPS Only: The GPS source uses only GPS satellites for position data.

Positioning Mode > GPS and GLONASS: The GPS source uses both GPS satellites and GLONASS (Russia satellite system) for position data. When the system is used in situations with poor sky visibility, GLONASS data can be used in combination with GPS to provide more accurate position information.

Positioning Mode > Multi-Constellation: The GPS source uses GPS data from all available satellite constellations for position data.

Positioning Mode > Multi-Constellation and Multi-Frequency: The GPS source uses GPS data from all available satellite constellations as well as both L1 and L5 frequencies for position data.

Station Settings

Select  > **System** > **Station Information**.

Change Station: Sets the entire station to a new set of defaults based on the location of this station. You can also select to use this display as a stand-alone, individual display, instead of grouping it with other displays to make a station.

Display Order: Sets the order of the displays, which is important when using a GRID™ remote input device.

Autopilot Enabled: Allows you to control the autopilot from this device.

Reset Layouts: Resets the layouts in this station to the factory default settings.

Reset Station Settings: Resets all station settings to on all connected devices in the station to the factory default settings, and requires initial station setup.

Viewing System Software Information

You can view the software version, the basemap version, all supplemental map information (if applicable), the software version for an optional Garmin® radar (if applicable), and the unit ID number. You may need this information to update the system software or to purchase additional map data information.

Select  > **System** > **System Information** > **Software Information**.

Viewing the Event Log

The event log shows a list of system events.

- 1 Select  > **System** > **System Information** > **Event Log**.
- 2 If necessary, select an event in the list, and select **Review** to view more information about the event.

Sorting and Filtering Events

- 1 From the **Event Log**, select **Sort By**.
- 2 Select an option to sort or filter the event log.

Saving Events to a Memory Card

- 1 Insert a memory card into the card slot.
- 2 From the **Event Log**, select **Save to Card**.

Clearing All of the Events From the Event Log

From the **Event Log**, select **Clear Event Log**.

Viewing E-label Regulatory and Compliance Information

The label for this device is provided electronically. The e-label may provide regulatory information, such as identification numbers provided by the FCC or regional compliance markings, as well as applicable product and licensing information. Not available on all models.

- 1 Select .
- 2 Select **System**.
- 3 Select **Regulatory Information**.

Preferences Settings

Select  > **Preferences**.

Units: Sets units of measure.

Language: Sets the on-screen text language.

Navigation: Sets navigation preferences.

Filters: Smooths out the values shown in the data fields, which can decrease the noise or show longer term trends. Increasing the filter setting increases the smoothing and decreasing it reduces the smoothing. A filter setting of 0 will disable the filter and the value shown will be the raw value from the source. You can also synchronize these settings across all devices that enable the Sync Filters setting.

Keyboard Layout: Arranges the keys on the on-screen keyboard.

Screenshot Capture: Allows the device to save images of the screen.

Menu Bar Display: Shows or automatically hides the menu bar when it is not needed.

Units Settings

Select  > **Preferences** > **Units**.

System Units: Sets the unit format for the device. For example, **Custom > Depth > Fathoms** sets the unit format for depth to Fathoms.

Variance: Sets the magnetic declination, the angle between magnetic north and true north, for your present location.

North Reference: Sets the direction references used in calculating heading information. True sets geographic north as the north reference. Grid sets grid north as the north reference (000°). Magnetic sets the magnetic north as the north reference.

Position Format: Sets the position format in which a given location reading appears. Do not change this setting unless you are using a map or chart that specifies a different position format.

Map Datum: Sets the coordinate system on which the map is structured. Do not change this setting unless you are using a map or chart that specifies a different map datum.

Time: Sets the time format, time zone, and daylight saving time.

Navigation Settings

NOTE: Some settings and options require additional charts or hardware.

Select  > **Preferences > Navigation.**

Route Labels: Sets the type of labels shown with route turns on the map.

Turn Transition: Adjusts how the chartplotter transitions to the next turn or leg or the route. You can set the transition to be based on time or distance before the turn. You can increase the time or distance value to help improve the accuracy of the autopilot when navigating a route or an Auto Guidance line with many frequent turns or at higher speeds. For straighter routes or slower speeds, lowering this value can improve autopilot accuracy.

Speed Sources: Sets the source for the speed readings.

Auto Guidance: Sets the measurements for the Preferred Depth, Vertical Clearance, and Shoreline Distance, when you are using some premium maps.

Route Start: Selects a starting point for route navigation.

Auto Guidance Path Configurations

CAUTION

The Preferred Depth and Vertical Clearance settings influence how the chartplotter calculates an Auto Guidance path. If a section of an Auto Guidance path is shallower than the Preferred Depth or lower than the Vertical Clearance settings, the section of the Auto Guidance path appears as a solid orange line or a red striped line in Garmin Navionics+™ and Garmin Navionics Vision+™ charts and appears as a magenta and gray striped line in previous versions. When your boat enters one of those areas, a warning message appears ([Route Color Coding, page 47](#)).

NOTE: Auto Guidance is available with premium charts, in some areas.

Not all settings apply to all maps.

You can set the parameters the chartplotter uses when calculating an Auto Guidance path.

Select  > **Preferences > Navigation > Auto Guidance.**

Preferred Depth: Sets the minimum water depth, based on chart depth data, that your boat can safely travel over.





NOTE: The minimum water depth for the premium charts (made before 2016) is 3 feet. If you enter a value of less than 3 feet, the charts only use depths of 3 feet for Auto Guidance path calculations.

Vertical Clearance: Sets the minimum height of a bridge or obstacle, based on chart data, that your boat can safely travel under.

Shoreline Distance: Sets how close to the shore you want the Auto Guidance path to be placed. The path may move if you change this setting while navigating. The available values for this setting are relative, not absolute. To ensure that path is placed the appropriate distance from shore, you can assess the placement of the path using one or more familiar destinations that require navigation through a narrow waterway ([Adjusting the Distance from Shore, page 53](#)).

Adjusting the Distance from Shore

The Shoreline Distance setting indicates how close to the shore you want the Auto Guidance line to be placed. The Auto Guidance line may move if you change this setting while navigating. The available values for the Shoreline Distance setting are relative, not absolute. To ensure the Auto Guidance line is placed the appropriate distance from shore, you can assess the placement of the Auto Guidance line using one or more familiar destinations that require navigation through a narrow waterway.

- 1 Dock your vessel or drop the anchor.
- 2 Select  > **Preferences** > **Navigation** > **Auto Guidance** > **Shoreline Distance** > **Normal**.
- 3 Select a destination that you have navigated to previously.
- 4 Select **Navigate To** > **Auto Guidance**.
- 5 Review the placement of the **Auto Guidance** line, and determine whether the line safely avoids known obstacles and the turns enable efficient travel.
- 6 Select an option:
 - If the placement of the line is satisfactory, select **...** > **Navigation Options** > **Stop Navigation**, and proceed to step 10.
 - If the line is too close to known obstacles, select  > **Preferences** > **Navigation** > **Auto Guidance** > **Shoreline Distance** > **Far**.
 - If the turns in the line are too wide, select  > **Preferences** > **Navigation** > **Auto Guidance** > **Shoreline Distance** > **Near**.
- 7 If you selected **Near** or **Far** in step 6, review the placement of the **Auto Guidance** line, and determine whether the line safely avoids known obstacles and the turns enable efficient travel.
Auto Guidance maintains a wide clearance from obstacles in open water, even if you set the Shoreline Distance setting to Near or Nearest. As a result, the chartplotter may not reposition the Auto Guidance line, unless the destination selected requires navigation through a narrow waterway.
- 8 Select an option:
 - If the placement of the line is satisfactory, select **...** > **Navigation Options** > **Stop Navigation**, and proceed to step 10.
 - If the line is too close to known obstacles, select  > **Preferences** > **Navigation** > **Auto Guidance** > **Shoreline Distance** > **Farthest**.
 - If the turns in the line are too wide, select  > **Preferences** > **Navigation** > **Auto Guidance** > **Shoreline Distance** > **Nearest**.
- 9 If you selected **Nearest** or **Farthest** in step 8, review the placement of the **Auto Guidance** line, and determine whether the line safely avoids known obstacles and the turns enable efficient travel.
The Auto Guidance path maintains a wide clearance from obstacles in open water, even if you set the Shoreline Distance setting to Near or Nearest. As a result, the chartplotter may not reposition the Auto Guidance line, unless the destination selected requires navigation through a narrow waterway.
- 10 Repeat steps 3 through 9 at least once more, using a different destination each time, until you are familiar with the functionality of the **Shoreline Distance** setting.

Communications Settings

Viewing Connected Devices

You can view lists of the connected devices on the vessel including which chartplotter a device is connected to or paired with.

- 1 Select  > **Communications**.
- 2 Select a network.
- 3 Select **Device List**.

A list of network devices appears. If a device is connected to or paired with a specific chartplotter, the name of the chartplotter is shown along with the device name.

NOTE: Some devices included in the NMEA 2000® device list may be connected to a chartplotter at another station on the vessel. You can select **Related To:** to see more information about which chartplotter the device is connected to.

NMEA 2000® Settings

Select  > **Communications** > **NMEA 2000 Setup**.

Device List: Displays the devices connected to the network and allows you to set options for some transducers connected using the NMEA 2000 network.

Label Devices: Changes the labels for available connected devices.

Naming Devices and Sensors on the Network

You can name devices and sensors connected to the Garmin® Marine Network and the NMEA 2000® network.

- 1 Select  > **Communications**.

- 2 Select **Marine Network** or **NMEA 2000 Setup > Device List**.
- 3 Select a device from the list on the left.
- 4 Select **Change Name**.
- 5 Enter the name, and select **Done**.

Setting Alarms

⚠ CAUTION

The Beeper setting must be turned on to make alarms audible (*Sounds and Display Settings, page 152*). Failure to set audible alarms could lead to injury or property damage.

Navigation Alarms

Select **⚙ > Alarms > Navigation**.

Arrival: Sets an alarm to sound when you are within a specified distance or time from a turn or a destination.

Anchor Drag: Sets an alarm to sound when you exceed a specified drift distance while anchored.

⚠ WARNING

The anchor drag alarm is a tool for situational awareness only and may not prevent groundings or collisions in all circumstances. You are responsible for the safe and prudent operation of your vessel, for remaining aware of your surroundings, and for using safe judgment on the water at all times.

Off Course: Sets an alarm to sound when you are off course by a specified distance.

Boundary Alarms: Disables and enables all boundary alarms.

Setting the Anchor Drag Alarm

You can set an alarm to sound if you have moved outside an allowable radius you set when configuring the alarm.

⚠ WARNING

The anchor drag alarm is a tool for situational awareness only, and may not prevent grounding or collisions in all circumstances. You are responsible for the safe and prudent operation of your vessel, for remaining aware of your surroundings, and for using safe judgement on the water at all times. Failure to heed this warning could result in property damage, serious personal injury, or death.

⚠ CAUTION

The Beeper setting must be turned on to make alarms audible (*Sounds and Display Settings, page 152*). Failure to set audible alarms could lead to injury or property damage.

- 1 Select **⚙ > Alarms > Navigation > Anchor Drag**.
- 2 Select **Alarm** to turn on the alarm.
- 3 Select **Set Radius**, and select a distance on the chart.
- 4 Select **Back**.

System Alarms

Select **⚙ > Alarms > System**.

Sets an alarm clock.

Unit Voltage: Sets an alarm to sound when the battery reaches a specified low voltage.

GPS Accuracy: Sets an alarm to sound when the GPS location accuracy falls outside the user-defined value.

Sonar Alarms

⚠ WARNING

The sonar alarms feature is a tool for situational awareness only and may not prevent grounding in all circumstances. It is your obligation to ensure safe operation of the vessel.

⚠ CAUTION

The Beeper setting must be turned on to make alarms audible (*Sounds and Display Settings, page 152*). Failure to set audible alarms could lead to injury or property damage.

NOTE: Not all options are available on all transducers.

From an applicable sonar view, select **☰ > Sonar Setup > Alarms**.

You can also open the sonar alarms by selecting **⚙ > Alarms > Sonar**.

Shallow Water: Sets an alarm to sound when the depth is less than the specified value.



Deep Water: Sets an alarm to sound when the depth is greater than the specified value.

FrontVü Alarm: Sets an alarm to sound when the depth in front of the vessel is less than the specified value, which can help you avoid running aground (*Setting the Garmin FrontVü™ Depth Alarm, page 84*). This alarm is available only with Panoptix™ Garmin FrontVü™ transducers.

Water Temp.: Sets an alarm to sound when the transducer reports a temperature that is 2°F (1.1°C) above or below the specified temperature.

Contour: Sets an alarm to sound when the transducer reports a water depth below a specified shallow limit or above a specified deep limit. This helps by calling attention when encountering a steep drop-off or a sudden shallow area.

Fish: Sets an alarm to sound when the device detects a suspended target.

-  sets the alarm to sound when fish of all sizes are detected.
-  sets the alarm to sound only when medium or large fish are detected.
-  sets the alarm to sound only when large fish are detected.

Setting the Fuel Alarm

⚠ CAUTION

The Beeper setting must be turned on to make alarms audible (*Sounds and Display Settings, page 152*). Failure to set audible alarms could lead to injury or property damage.

Before you can set a fuel level alarm, you must connect a compatible fuel flow sensor to the chartplotter.

You can set an alarm to sound when the total amount of remaining onboard fuel reaches the level you specify.

- 1 Select  > **Alarms** > **Fuel** > **Total Fuel Onboard** > **On**.
- 2 Enter the remaining amount of fuel that triggers the alarm, and select **Done**.

My Vessel Settings

NOTE: Some settings and options require additional charts or hardware.

Select  > **My Vessel**.

Transducers: Shows all transducers on the network, allows you to change transducers, and allows you to view diagnostic information (*Selecting the Transducer Type, page 76*).

Depth and Anchoring: Allows you to enter information about the keel (*Setting the Keel Offset, page 63*) and the anchor.

The Anchor Height value is the height of the anchor above the waterline. The Anchor Scope value is the ratio of the length of anchor rode in use to the vertical distance from the bow of the vessel to the bottom of the water. These anchor settings are used to calculate the Target Anchor Rode date field.

Temp. Offset: Allows you to set an offset value to compensate for the water temperature reading from a connected water-temperature sensor or a temperature-capable transducer (*Setting the Water Temperature Offset, page 158*).

Calibrate Water Speed: Calibrates the speed-sensing transducer or sensor (*Calibrating a Water-Speed Device, page 159*).

Fuel: Sets the combined fuel capacity and fuel remaining in the fuel tanks on your vessel (*Fuel Settings, page 159*).

Vessel Type: Enables some chartplotter features based on the boat type.

Switching: Sets the digital switching circuits, such as SeaStar® and CZone™ devices.

Polar Table: Enables polar table data, when the vessel type is not a powerboat.

System Profiles: Allows you to save your system profile to a memory card and import system profile settings from a memory card. This can be helpful for charter or fleet vessels, and for sharing your setup information with a friend.

Hull ID Number: Allows you to enter the Hull Identification Number (HIN). The HIN might be permanently affixed to the upper starboard side of the transom or outboard side.

Optimus Steering: Allows you to adjust the Optimus® steering parameters.

Setting the Keel Offset

You can enter a keel offset to compensate the water depth reading for the transducer installation location. This allows you to view the depth of the water below the keel or the true depth of the water, depending on your needs.

If you want to know the water depth below the keel or the lowest point of your boat and the transducer is installed at the water line or anywhere above the end of the keel, measure the distance from the transducer location to the keel of the boat.

If you want to know the true water depth and the transducer is installed below the water line, measure the distance from the bottom of the transducer up to the water line.

NOTE: This option is only available when you have valid depth data.

1 Measure the distance:

- If the transducer is installed at the water line ① or anywhere above the end of the keel, measure the distance from the transducer location to the keel of the boat. Enter this value as a positive number.
- If the transducer is installed at the bottom of the keel ② and you want to know the true depth of the water, measure the distance from the transducer to the water line. Enter this value in as a negative number.

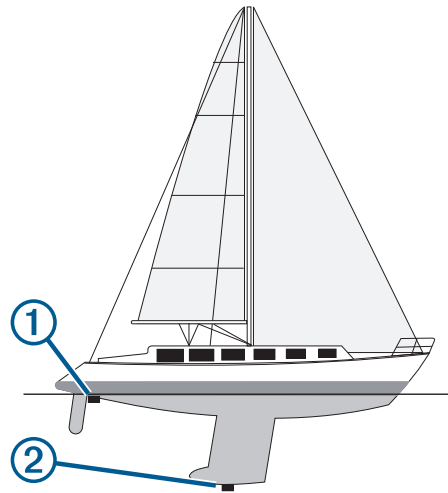

2 Complete an action:

- If the transducer is connected to the chartplotter or a sonar module, select **⚙️ > My Vessel > Depth and Anchoring > Keel Offset**.
- If the transducer is connected to the NMEA 2000® network, select **⚙️ > Communications > NMEA 2000 Setup > Device List**, select the transducer, and select **Review > Keel Offset**.

3 Select **+** if the transducer is installed at the water line, or select **-** if the transducer is installed at the bottom of the keel.

4 Enter the distance measured in step 1.

Setting the Water Temperature Offset

The temperature offset compensates for the temperature reading from a temperature sensor or temperature-capable transducer.

- 1 Measure the water temperature using the temperature sensor or temperature-capable transducer that is connected to the network.
- 2 Measure the water temperature using a different temperature sensor or a thermometer that is known to be accurate.
- 3 Subtract the water temperature measured in step 1 from the water temperature measured in step 2. This value is the temperature offset. Enter this value in step 5 as a positive number if the sensor measures the water temperature as being colder than it actually is. Enter this value in step 5 as a negative number if the sensor measures the water temperature as being warmer than it actually is.
- 4 Complete an action:
 - If the sensor or transducer is connected to the chartplotter or a sonar module, select **⚙️ > My Vessel > Temp. Offset**.
 - If the sensor or transducer is connected to the NMEA 2000® network, select **⚙️ > Communications > NMEA 2000 Setup > Device List**, select the transducer, and select **Review > Temp. Offset**.
- 5 Enter the temperature offset value calculated in step 3.

Fuel Settings

Select  > **My Vessel** > **Fuel**.

Fuel Remaining: Allows you to use fuel flow sensors or fuel tank level sensors to monitor the fuel remaining on the vessel. The Fuel Flow option uses fuel flow sensors. The Fuel Tank option uses fuel tank level sensors.

Fuel Tank Capacity: Allows you to enter the fuel capacity of each fuel tank onboard. This setting is available when the Fuel Remaining setting is set to the Fuel Tank option. The chartplotter uses information from the tank level sensors, so you do not need to do manually enter fuel information after you fill up the tanks.

Fuel Capacity: Allows you to enter the total fuel capacity of all fuel tanks onboard. This setting is available when the Fuel Remaining setting is set to the Fuel Flow option. After you fill up your tanks with fuel, you must enter fuel information manually using one of the options below.

- If you have filled up all the fuel tanks on the vessel, select Fill Up All Tanks. The fuel level is set to maximum capacity.
- If you have added less than a full tank of fuel, select Add Fuel to Boat, and enter the amount added.
- To specify the total fuel in the vessel tanks, select Set Total Fuel Onboard, and enter the total amount of fuel in the tanks.



Fuel Economy: Determines how the fuel economy data is shown in data fields and other locations in the chartplotter.

- To show fuel economy data as it is received directly from the engine, select Instant. Not all engines support this feature.
- To allow the chartplotter to calculate the fuel economy data based on fuel-rate measurements, select Internal.
- To allow the chartplotter to either use data received from the engine or to calculate the data if it is not received by the engine, select Auto. This is the default setting.

NOTE: Garmin® is not responsible for the accuracy of fuel economy data provided by an engine.

Calibrating a Water-Speed Device

If you have a speed sensor or a speed-sensing transducer connected, you can calibrate that speed-sensing device to improve the accuracy of water-speed data displayed by the chartplotter.

- 1 Complete an action:
 - If the sensor or transducer is connected to the chartplotter or a sonar module, select  > **My Vessel** > **Calibrate Water Speed**.
 - If the sensor or transducer is connected to the NMEA 2000® network, select  > **Communications** > **NMEA 2000 Setup** > **Device List**, select the transducer, and select **Review** > **Calibrate Water Speed**.
- 2 Follow the on-screen instructions.
If the boat is not moving fast enough or the speed sensor is not registering a speed, a message appears.
- 3 Select **OK**, and safely increase the boat speed.
- 4 If the message appears again, stop the boat, and ensure the speed-sensor wheel is not stuck.
- 5 If the wheel turns freely, check the cable connections.
- 6 If you continue to get the message, contact Garmin® product support.

Other Vessels Settings

CAUTION

The Beeper setting must be turned on to make alarms audible ([Sounds and Display Settings, page 152](#)). Failure to set audible alarms could lead to injury or property damage.

When your compatible chartplotter is connected to an AIS device or VHF radio, you can set up how other vessels are displayed on the chartplotter.

Select  > **Other Vessels**.

AIS: Enables and disables AIS signal reception.

DSC: Enables and disables digital selective calling (DSC).

Collision Alarm: Sets the collision alarm ([Setting the Safe-Zone Collision Alarm, page 38](#)).

AIS-EPIRB Test: Enables test signals from Emergency Position Indicating Radio Beacons (EPIRB).

AIS-MOB Test: Enables test signals from man overboard (MOB) devices.

AIS-SART Test: Enables test transmissions from Search and Rescue Transponders (SART).

Restoring the Original Chartplotter Factory Settings

NOTE: This affects all devices on the network.

1 Select  > **System** > **System Information** > **Reset**.

2 Select an option:

- To reset the device settings to the factory default values, select **Reset Default Settings**. This restores the default configuration settings, but does not remove saved user data, maps, or software updates.
- To reset all settings in all devices in the station to the factory default values, select **Reset Station Settings**. This restores the default configuration settings, but does not remove saved user data, maps, or software updates
- To clear saved data, such as waypoints and routes, select **Delete User Data**. This does not affect maps or software updates.
- To clear saved data and reset device settings to the factory default values, disconnect the chartplotter from the Garmin® Marine Network, and select **Delete Data and Reset Settings**. This does not affect maps or software updates.

Sharing and Managing User Data

WARNING

This feature allows you to import data from other devices that may have been generated by third parties. Garmin® makes no representations about the accuracy, completeness, or timeliness of data that is generated by third parties. Any reliance on or use of such data is at your own risk.

You can share user data between compatible devices. User data includes waypoints, saved tracks, routes, and boundaries.

- You can share and manage user data between different devices using a memory card. The memory card you use must be formatted to a file type supported by all devices that you want to share user data. For example, if you have one device that supports only FAT32 format cards and another device that supports exFat format cards, you should use a card formatted to FAT32 so that it can be read by both devices (*Inserting Memory Cards*, page 14).

Selecting a File Type for Third-Party Waypoints and Routes

You can import and export waypoints and routes from third-party devices.

- 1 Insert a memory card into the card slot.
- 2 Select **Where To > Manage User Data > Data Transfer > File Type**.
- 3 Select **GPX**.

To transfer data with Garmin® devices again, select the ADM file type.

Copying User Data from a Memory Card

You can transfer user data from a memory card to transfer from other devices. User data includes waypoints, routes, Auto Guidance paths, tracks, and boundaries.

NOTE: Only boundary files with an .adm extension are supported.

- 1 Insert a memory card into a card slot.
- 2 Select **Where To > Manage User Data > Data Transfer**.
- 3 If necessary, select the memory card to copy data to.
- 4 Select an option:
 - To transfer data from the memory card to the chartplotter and combine it with existing user data, select **Merge from Card**.
 - To transfer data from the memory card to the chartplotter and overwrite existing user data, select **Replace from Card**.
- 5 Select the file name.

Copying All User Data to a Memory Card

You can save all of the user data on the device to a memory card to transfer to other devices. User data includes waypoints, routes, Auto Guidance paths, tracks, and boundaries.

- 1 Insert a memory card into the card slot.
- 2 Select **Where To > Manage User Data > Data Transfer > Save All to Card**.
- 3 If necessary, select the memory card to copy the data to.
- 4 Select an option:
 - To create a new file, select **Add New File**, and enter a name.
 - To add the information to an existing file, select the file from the list, and select **Save to Card**.

Copying User Data from a Specified Area to a Memory Card

You can save user data from a specified area to a memory card to transfer to other devices. User data includes waypoints, routes, Auto Guidance paths, tracks, and boundaries.

- 1 Insert a memory card into the card slot.
- 2 Select **Where To > Manage User Data > Data Transfer > Save Area to Card**.
- 3 Select an option:
 - If you previously defined an area boundary containing user data you want to transfer, select the name of the area and select **Select Area**.
 - If you want to define a new area containing user data to transfer, select **New Area**, and follow the on-screen instructions to define the area.

- 4 Select **Save Area to Card**.
- 5 If necessary, select the memory card to copy the data to.
- 6 Select an option:
 - To create a new file, select **Add New File**, and enter a name.
 - To add the information to an existing file, select the file from the list, and select **Save to Card**.

Updating Built-In Maps with a Memory Card and Garmin Express™

You can update the built-in maps using the Garmin Express computer application and a memory card.

- 1 Insert a memory card into the computer's card slot (*Inserting Memory Cards, page 14*).
- 2 Open the Garmin Express application.
If you do not have the Garmin Express application installed on your computer, you can download it from garmin.com/express.
- 3 If necessary, register your device (*Registering Your Device Using the Garmin Express™ App, page 164*).
- 4 Click **Vessel > View Details**.
- 5 Click **Download** next to the map to update.
- 6 Follow the on-screen instructions to complete the download.
- 7 Wait while the update downloads.
The update may take an extended period of time.
- 8 After the download is complete, eject the card from the computer.
- 9 Insert the memory card into the card slot (*Inserting Memory Cards, page 14*).
- 10 On the chartplotter, select **⚙ > System > System Information > Update Built-In Map**.
The updated chart appears on your chartplotter.

Backing Up Data to a Computer

- 1 Insert a memory card into the card slot.
- 2 Select **Where To > Manage User Data > Data Transfer > Save to Card**.
- 3 Select a file name from the list, or select **Add New File**.
- 4 Select **Save to Card**.
- 5 Remove the memory card, and insert it into a card reader attached to a computer.
- 6 Open the Garmin\UserData folder on the memory card.
- 7 Copy the backup file on the card and paste it to any location on the computer.

Restoring Backup Data to a Chartplotter

- 1 Insert a memory card into a card reader that is attached to the computer.
- 2 Copy a backup file from the computer to the memory card, into a folder named Garmin\UserData.
- 3 Insert a memory card into the card slot.
- 4 Select **Where To > Manage User Data > Data Transfer > Replace from Card**.

Saving System Information to a Memory Card

You can save system information to a memory card as a troubleshooting tool. A product support representative may ask you to use this information to retrieve data about the network.

- 1 Insert a memory card into the card slot.
- 2 Select **⚙ > System > System Information > Garmin Devices > Save to Card**.
- 3 If necessary, select the memory card to save system information to.
- 4 Remove the memory card.

Appendix

Device Care

NOTICE

Do not use a sharp object to clean the device.

Avoid chemical cleaners, solvents, and insect repellents that can damage plastic components and finishes.

Thoroughly rinse the device with fresh water after exposure to chlorine, salt water, sunscreen, cosmetics, alcohol, or other harsh chemicals. Prolonged exposure to these substances can damage the case.

Never use a hard or sharp object to operate the touchscreen, or damage may result.

Cleaning the Screen

NOTICE

Cleaners containing ammonia will harm the anti-reflective coating.

The device is coated with a special anti-reflective coating which is very sensitive to waxes and abrasive cleaners.

- 1 Apply an eyeglass lens cleaner specified as safe for anti-reflective coatings to the cloth.
- 2 Gently wipe the screen with a soft, clean, lint-free cloth.

ActiveCaptain® and Garmin Express™

The ActiveCaptain and Garmin Express apps help you manage your Garmin® chartplotter and other devices.

ActiveCaptain: The ActiveCaptain mobile app provides an easy-to-use connection between your compatible mobile device and your compatible Garmin chartplotter, charts, and the Garmin Quickdraw™ Contours Community (*ActiveCaptain® App, page 26*). The app provides unlimited access to your cartography and a quick, mobile way to download new charts using the OneChart™ feature, provides a link to receive notifications on your chartplotter, and provides access to the ActiveCaptain Community for feedback on marinas and other boating points of interest. You can also use the app to plan your trip and sync user data. The app checks your devices for available updates, and notifies you when an update is available.

Garmin Express: The Garmin Express desktop app allows you to use your computer and a memory card to download and update Garmin chartplotter software and charts (*Garmin Express™ App, page 163*). You should use the Garmin Express app for faster data transfer of larger downloads and updates, and to avoid possible data charges with some mobile devices.

Function	ActiveCaptain mobile app	Garmin Express desktop app
Register your new Garmin Marine device	Yes	Yes
Update your Garmin chartplotter software	Yes	Yes
Update your Garmin charts	Yes	Yes
Download new Garmin charts	Yes	Yes
Access the Garmin Quickdraw Contours Community to download and share contours with other users	Yes	No
Sync a mobile device with your Garmin chartplotter	Yes	No
Access the ActiveCaptain Community for feedback on marinas and boating points of interest	Yes	No

Garmin Express™ App

The Garmin Express desktop app allows you to use your computer and a memory card to download and update Garmin® device software and charts and register your devices. We recommend it for larger downloads and updates for faster data transfer and to avoid possible data charges with some mobile devices.

Installing the Garmin Express™ App on a Computer

You can install the Garmin Express app on a Windows® or Mac® computer.

- 1 Go to garmin.com/express.
- 2 Select **Download for Windows** or **Download for Mac**.
- 3 Follow the on-screen instructions.

Registering Your Device Using the Garmin Express™ App

NOTE: You should use the ActiveCaptain® app and a mobile device to register the device (*Getting Started with the ActiveCaptain® App*, page 26).

Help us better support you by completing our online registration today. Keep the original sales receipt, or a photocopy, in a safe place.

- 1 Install the Garmin Express app on your computer (*Installing the Garmin Express™ App on a Computer*, page 163).
- 2 Insert a memory card into the chartplotter card slot (*Inserting Memory Cards*, page 14).
- 3 Wait a few moments.
The chartplotter opens the card management page and creates a file named GarminDevice.xml in the Garmin® folder on the memory card.
- 4 Remove the memory card from your device.
- 5 Open the Garmin Express app on your computer.
- 6 Insert the memory card into your computer.
- 7 If necessary, select **Get Started**.
- 8 If necessary, while the application searches, select **Sign In** next to **Have marine charts or devices?** near the bottom of the screen.
- 9 Create or sign in to your Garmin account.
- 10 Follow the on-screen instructions to set up your vessel.
- 11 Select **+ > Add**.
The Garmin Express application searches the memory card for the device information.
- 12 Select **Add Device** to register the device.
When registration is complete, the Garmin Express application searches for additional charts and chart updates for your device.

When you add devices to the chartplotter network, repeat these steps to register the new devices using the Garmin Express app.

Updating Your Charts Using the Garmin Express™ App

As of software version 34.00, this device supports two microSD® memory cards up to 1 TB, formatted to exFAT with speed class 10 or higher.

Downloading the chart update may take up to a few hours.

You should use a blank memory card for chart updates. The update process erases the content on the card and reformats the card.

- 1 Install the Garmin Express app on your computer (*Installing the Garmin Express™ App on a Computer*, page 163).
- 2 Open the Garmin Express app on your computer.
- 3 Select your vessel and device.
- 4 If chart updates are available, select **Chart Updates > Continue**.
- 5 Read and agree to the terms.
- 6 Insert your chartplotter chart memory card into the computer.
- 7 Select the drive for the memory card.
- 8 Review the reformat warning, and select **OK**.
- 9 Wait while the chart update is copied to the memory card.
Copying the update file onto the card may take from a few minutes up to a few hours.
- 10 Close the Garmin Express app.
- 11 Eject the memory card from the computer.
- 12 Turn on the chartplotter.
- 13 After the home screen appears, insert the memory card into the card slot.
NOTE: In order for the update instructions to appear, the device must be fully booted before the card is inserted.
- 14 Select **Update Software > Yes**.
- 15 Wait several minutes while the update process completes.

16 When prompted, leave the memory card in place, and restart the chartplotter.

17 Remove the memory card.

NOTE: If the memory card is removed before the device restarts fully, the update is not complete.

Software Updates

You may need to update the software when you install a new device or add an accessory.

You can use the ActiveCaptain® mobile app to update the device software (*Updating Software with the ActiveCaptain® App, page 26*).

You can also use the Garmin Express™ desktop app to update your chartplotter software (*Loading the New Software on a Memory Card Using Garmin Express™, page 165*).

As of software version 34.00, this device supports two microSD® memory cards up to 1 TB, formatted to exFAT with speed class 10 or higher.

The Garmin® memory card reader accessory is sold separately.

Before you update the software, you should check the software version installed on your device (*Viewing System Software Information, page 153*). Then, you can go to garmin.com/support/software/marine.html, select See All Devices in this Bundle, and compare the installed software version to the software version listed for your product.

If the software version installed on your device is older than the version listed on the website, you should update the software using the ActiveCaptain mobile app (*Updating Software with the ActiveCaptain® App, page 26*) or the Garmin Express desktop app (*Loading the New Software on a Memory Card Using Garmin Express™, page 165*).

Loading the New Software on a Memory Card Using Garmin Express™

You can copy the software update to a memory card using a computer with the Garmin Express app.

As of software version 34.00, this device supports two microSD® memory cards up to 1 TB, formatted to exFAT with speed class 10 or higher.

Downloading the software update may take from a few minutes up to a few hours.

You should use a blank memory card for software updates. The update process erases the content on the card and reformats the card.

- 1 Insert a memory card into the card slot on the computer.
- 2 Install the Garmin Express app (*Installing the Garmin Express™ App on a Computer, page 163*).
- 3 Select your vessel and device.
- 4 Select **Software Updates > Continue**.
- 5 Read and agree to the terms.
- 6 Select the drive for the memory card.
- 7 Review the reformat warning, and select **Continue**.
- 8 Wait while the software update is copied to the memory card.
Copying the update file onto the card may take from a few minutes up to a few hours.
- 9 Close the Garmin Express app.
- 10 Eject the memory card from the computer.

After loading the update onto the memory card, install the software on the chartplotter (*Updating the Device Software Using a Memory Card, page 165*).

Updating the Device Software Using a Memory Card

To update the software using a memory card, you must obtain a software-update memory card or load the latest software onto a memory card using the Garmin Express™ app (*Loading the New Software on a Memory Card Using Garmin Express™, page 165*).

- 1 Turn on the chartplotter.
- 2 After the home screen appears, insert the memory card into the card slot.
NOTE: In order for the software update instructions to appear, the device must be fully booted before the card is inserted.
- 3 Select **Install Now > Update Software > Yes**.
- 4 Wait several minutes while the software update process completes.
- 5 When prompted, leave the memory card in place, and restart the chartplotter.
- 6 Remove the memory card.

NOTE: If the memory card is removed before the device restarts fully, the software update is not complete.

Viewing Images on a Memory card

You can view images that are saved on a memory card. You can view .jpg, .png, and .bmp files.

- 1 Insert a memory card with image files into the card slot.
- 2 Select  > **Image Viewer**.
- 3 Select the folder containing the images.
- 4 Wait a few seconds for the thumbnail images to load.
- 5 Select an image.
- 6 Use the arrows to scroll through the images.
- 7 If necessary, select **...** > **Start Slideshow**.

Screenshots

You can capture a screenshot of any screen shown on your chartplotter as a .png file. You can transfer the screenshot to your computer. You can also view the screenshot in the image viewer ([Viewing Images on a Memory card, page 166](#)).

Capturing Screenshots

- 1 Insert a memory card into the card slot.
- 2 Go to a screen you want to capture.
- 3 Hold **Home** or  for at least six seconds.

A message appears to confirm the screenshot was captured, including the name of the file written to the memory card.

Copying Screenshots to a Computer

- 1 Remove the memory card from the chartplotter, and insert it into a card reader that is attached to a computer.
- 2 From Windows® Explorer, open the Garmin\scrn folder on the memory card.
- 3 Copy the image file from the card and paste it to any location on the computer.

Troubleshooting

My device will not acquire GPS signals

If the device is not acquiring satellite signals, there could be a few causes. If the device has moved a large distance since the last time it has acquired satellites or has been turned off for longer than a few weeks or months, the device may not be able to acquire the satellites correctly.

- Ensure the device is using the latest software. If not, update the device software ([Software Updates, page 165](#)).
- Make sure the device has a clear view of the sky so the antenna can receive the GPS signal. If it is mounted inside of a cabin, it should be close to a window so it can receive the GPS signal.

My device will not turn on or keeps turning off

Devices erratically turning off or not turning on could indicate an issue with the power supplied to the device. Check these items to attempt to troubleshoot the cause of the power issue.

- Make sure the power source is generating power.
You can check this several ways. For example, you can check whether other devices powered by the source are functioning.
- Check the fuse in the power cable.
The fuse should be located in a holder that is part of the red wire of the power cable. Check that the proper size fuse is installed. Refer to the label on the cable or the installation instructions for the exact fuse size needed. Check the fuse to make sure there is still a connection inside of the fuse. You can test the fuse using a multimeter. If the fuse is good, the multimeter reads 0 ohm.
- Check to make sure the device is receiving at least 12 Vdc.
To check the voltage, measure the female power and ground sockets of the power cable for DC voltage. If the voltage is less than 12 Vdc, the device will not turn on.
- If the device is receiving enough power but does not turn on, contact Garmin® product support.

My device is not creating waypoints in the correct location

You can manually enter a waypoint location to transfer and share data from one device to the next. If you have manually entered a waypoint using coordinates, and the location of the point does not appear where the point should be, the map datum and position format of the device may not match the map datum and position format originally used to mark the waypoint.

Position format is the way in which the GPS receiver's position appears on the screen. This is commonly displayed as latitude/longitude in degrees and minutes, with options for degrees, minutes and second, degrees only, or one of several grid formats.

Map datum is a math model which depicts a part of the surface of the earth. Latitude and longitude lines on a paper map are referenced to a specific map datum.

- 1 Find out which map datum and position format was used when the original waypoint was created.
If the original waypoint was taken from a map, there should be a legend on the map that lists the map datum and position format used to create that map. Most often this is found near the map key.
- 2 Select  > **Preferences** > **Units**.
- 3 Select the correct map datum and position format settings.
- 4 Create the waypoint again.

Viewing E-label Regulatory and Compliance Information

The label for this device is provided electronically. The e-label may provide regulatory information, such as identification numbers provided by the FCC or regional compliance markings, as well as applicable product and licensing information. Not available on all models.

- 1 Select .
- 2 Select **System**.
- 3 Select **Regulatory Information**.

Specifications

ECHOMAP™ Ultra 2 10Xsv and 12Xsv models

All 100 Series and 120 Series Models

Material	Polycarbonate plastic
Water rating	IEC 60529 IPX7 ⁵
Temperature range	From -15° to 55°C (from 5° to 131°F)
Clearance to nearest obstruction behind chartplotter	150 mm (5 ⁷ / ₈ in.)
Input voltage	From 9 to 18 Vdc
Fuse	8 A, fast-blow (included)
Display resolution (W x H)	1280 x 800 pixels
Display type	WXGA
Memory card	2 microSD [®] card slots; 1 TB max. card size ⁶
Wireless frequency	2.4 GHz @ 16.6 dBm maximum
Sonar frequencies ⁷	Traditional L, M, H CHIRP: 50/77/83/200 kHz Garmin ClearVü™ CHIRP: 260/455/800/1000/1200 kHz Garmin SideVü™ CHIRP: 260/455/800/1000/1200 kHz
Sonar transmit power (RMS) ⁸	CHIRP: 600 W Garmin ClearVü and Garmin SideVü CHIRP: 600 W
Sonar depth ⁹	701 m (2,300 ft.) at 77 kHz

⁵ The device withstands incidental exposure to water of up to 1 m for up to 30 min. For more information, go to www.garmin.com/waterrating.

⁶ As of software version 35.00, this device is compatible with up to 1 TB memory cards formatted to exFAT.

⁷ Dependent upon the transducer.

⁸ Dependent upon the transducer rating and depth.

⁹ Dependent upon the transducer, water salinity, bottom type, and other water conditions.

100 Series Models

Dimensions, device only (W x H x D)	295 x 195 x 98 mm (11 ⁵ / ₈ x 7 ¹¹ / ₁₆ x 3 ⁷ / ₈ in.)
Dimensions, in bail mount with sun cover (W x H x D)	314 x 211 x 114 mm (12 ³ / ₈ x 8 ⁵ / ₁₆ x 4 ¹ / ₂ in.)
Display size (W x H)	218 x 137 mm (8 ⁹ / ₁₆ x 5 ³ / ₈ in.) 257 mm (10 in.) diagonal
Weight	1.75 kg (3 lb. 14 oz.)
Max. power draw	34 W
Typical current draw at 12 Vdc (RMS)	2.3 A
Max. current draw at 12 Vdc (peak)	5 A
Compass-safe distance	10 cm (3.9 in.)

120 Series Models

Dimensions, device only (W x H x D)	341 x 229 x 98 mm (13 ⁷ / ₁₆ x 9 x 3 ⁷ / ₈ in.)
Dimensions, in bail mount with sun cover (W x H x D)	352 x 235 x 114 mm (13 ⁷ / ₈ x 9 ¹ / ₄ x 4 ¹ / ₂ in.)
Display size (W x H)	262 x 164 mm (10 ⁵ / ₁₆ x 6 ¹⁵ / ₃₂ in.) 309 mm (12 in.) diagonal
Weight	2.46 kg (5 lb. 7 oz.)
Max. power draw	36 W
Typical current draw at 12 Vdc (RMS)	2.5 A
Max. current draw at 12 Vdc (peak)	5 A
Compass-safe distance	9 cm (3.5 in.)

ECHOMAP™ Ultra 2 16Xsv models

Temperature range	From -15° to 55°C (from 5° to 131°F)
Material	Polycarbonate plastic and die-cast aluminum
Water rating	IEC 60529 IPX7 ¹⁰
Input voltage	From 9 to 18 Vdc
NMEA 2000® LEN @ 9 Vdc	2
NMEA 2000 draw	75 mA max.
Memory card	2 microSD® memory card slots, 1 TB max. card size, formatted to exFAT.
Dimensions (W x H x D)	384.7 x 266.4 x 78 mm (15 ¹ / ₈ x 10 ¹ / ₂ x 3 ¹ / ₁₆ in.)
Dimensions with cover on bail mount (W x H x D)	405.9 x 277.3 x 110 mm (16 x 10 ¹⁵ / ₁₆ x 4 ³ / ₈ in.)
Clearance to next obstruction behind chartplotter	94 mm (3 ³ / ₄ in.)
Display size (W x H)	345.2 x 194.6 mm (13 ⁹ / ₁₆ x 7 ¹¹ / ₁₆ in.) 396.3 mm (15 ⁵ / ₈ in.) diagonal
Display resolution	FHD, 1920 x 1080 pixels (IPS)
Weight	4.45 kg (9.8 lb.)
Compass-safe distance	85 cm (33.5 in.)
Wireless frequency	2.4 GHz @ 16.4 dBm maximum
Max. power usage at 10 Vdc	45 W
RMS current draw at 12 Vdc	3.6A @ 12V

¹ The device withstands incidental exposure to water of up to 1 m for up to 30 min. For more information, go to www.garmin.com/waterrating.

Peak current draw at 12 Vdc	6.5A @ 12V
Fuse	8 A, 125 V fast-acting

Recommended Startup Image Dimensions

For the best fit for the startup images, use an image that has the following dimensions, in pixels.

Model	Display resolution	Image width	Image height
ECHOMAP™ Ultra 2 10Xsv and 12Xsv models	WXGA	1080	350
ECHOMAP Ultra 2 16Xsv models	FHD	1240	450

Network Interfaces and Services

Devices connected to the chartplotter using a Garmin BlueNet™ cable, a Garmin® Marine Network cable, or other Ethernet cable use these network interfaces and services. These interfaces and services are enabled by default, cannot be disabled, and are required for proper equipment operation.

- Garmin proprietary services
- DHCP
- HTTP
- LLDP
- NFS
- RPC Bind
- SSH
- Telnet
- mDNS

NOTE: When you connect a new chartplotter to the network, private information is synchronized with the newly-added device.

NMEA 2000® PGN Information

Transmit and Receive

PGN	Description
059392	ISO acknowledgment
059904	ISO request
060160	ISO transport protocol, data transfer
060416	ISO transport protocol, connection management - RTS group function
060928	ISO address claim
126208	NMEA®: Command, request, and acknowledge group function
126993	Heartbeat
126996	Product information
126998	Configuration information
127250	Vessel heading
128259	Speed: Water referenced
128267	Water depth
129539	GNSS DOPs
129540	GNSS satellites in view
129799	Radio frequency, mode, and power
130060	Label
130306	Wind data
130310	Environmental parameters
130312	Temperature

Transmit

PGN	Description
126464	Transmit and receive PGN list group function
126984	Alert response
127258	Magnetic variance
127502	Switch bank control
129025	Position: Rapid update
129026	COG and SOG: Rapid update
129029	GNSS position data
129283	Cross track error
129284	Navigation data
129285	Navigation route and waypoint info

Receive

PGN	Description
065240	ISO commanded address
126983	Alert
126985	Alert text
126987	Alert threshold
126988	Alert value
126992	System time
127233	Man overboard
127237	Heading/tack control
127245	Rudder
127250	Vessel heading
127251	Rate of turn
127252	Heave
127257	Attitude
127488	Engine parameters: Rapid update
127489	Engine parameters: Dynamic
127493	Transmission parameters: Dynamic
127498	Engine parameters: Static
127501	Switch bank status
127503	AC input status
127504	AC output status
127505	Fluid level
127506	DC detailed status
127507	Charger status
127508	Battery status
127509	Inverter status
128000	Nautical leeway angle
128275	Distance log
128780	Linear actuator control and status
129025	Position, rapid update
129026	COG and SOG, rapid update
129029	GNSS position data

PGN	Description
129038	AIS class A position report
129039	AIS class B position report
129040	AIS class B extended position report
129041	AIS Aids to Navigation (AtoN) report
129283	Cross track error
129284	Navigation data
129285	Navigation: Route and waypoint information
129794	AIS class A static and voyage related data
129798	AIS SAR aircraft position report
129799	Radio frequency, mode, and power
129802	AIS safety-related broadcast message
129808	DSC call information
129809	AIS static data report, part A
129810	AIS static data report, part B
130067	Route and waypoint service: Route and waypoint name and position
130310	Environmental parameters
130311	Environmental parameters (obsolete)
130313	Humidity
130314	Actual pressure
130316	Temperature: extended range
130576	Trim tab status
130578	Vessel speed components

联系信息

制造厂商：台湾国际航电股份有限公司

销售厂商：上海佳明航电企业管理有限公司

联络地址：上海市徐汇区桂平路 391 号（新漕河泾国际商务中心 A 座 37 层）

电话：021-60737675

客服专线：400-819-1899

support.garmin.com

© 2023 Garmin Ltd. or its subsidiaries

Garmin®, the Garmin logo, ActiveCaptain®, and BlueChart® are trademarks of Garmin Ltd. or its subsidiaries, registered in the USA and other countries. ECHOMAP™, Garmin ClearVü™, Garmin Connect™, Garmin Express™, Garmin LakeVü™, Garmin Quickdraw™, Garmin Navionics Vision+™, Panoptix™, and OneChart™ are trademarks of Garmin Ltd. or its subsidiaries. These trademarks may not be used without the express permission of Garmin.

Mac® is a trademark of Apple Inc., registered in the U.S. and other countries. microSD® and the microSD logo are trademarks of SD-3C, LLC. Standard Mapping® is a trademark of Standard Mapping Service, LLC. Wi-Fi® is a registered mark of Wi-Fi Alliance Corporation. Windows® is a registered trademark of Microsoft Corporation in the United States and other countries. All other trademarks and copyrights are the property of their respective owners.